

MDM500H65E2

FEATURES

- * Low noise recovery: Ultra soft fast recovery diode.
- * High reverse recovery capability: Super HiRC Structure.
- * High reliability, high durability diodes.
- * Isolated heat sink (terminal to base).

CIRCUIT DIAGRAM

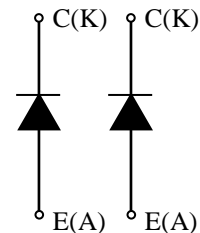

ABSOLUTE MAXIMUM RATINGS (T_C=25°C)

Item		Symbol	Unit	MDM500H65E2	
Repetitive Peak Reverse Voltage	T _j =125°C	V _{RRM}	V	6,500	
	T _j =25°C			6,500	
	T _j =-40°C			6,000	
Forward Current	DC	I _F	A	500	
	1ms	I _{FM}		1,000	
Junction Temperature		T _j	°C	-40 ~ +125	
Storage Temperature		T _{stg}	°C	-50 ~ +125	
Isolation Test Voltage	Terminals-base	V _{ISO}	V _{RMS}	10,200 (AC 1 minute)	
	Terminal 1-Terminal 2	V _{ISO T-T}		10,200 (AC 1 minute)	
Screw Torque	Terminals (M8)	-	N·m	10	(1)
	Mounting (M6)	-		6	(2)

Notes: (1) Recommended Value 9±1N·m (2) Recommended Value 5.5±0.5N·m

ELECTRICAL CHARACTERISTICS

Item	Symbol	Unit	Min.	Typ.	Max.	Test Conditions
Repetitive Reverse Current	I _{RRM}	mA	-	7	50	V _{AK} =6,500V, T _j =125°C
Forward Voltage Drop	V _F	V	-	3.7	-	I _F =500A, T _j =25°C
			3.7	4.1	4.6	I _F =500A, T _j =125°C
Reverse Recovery Time	t _{rr}	μs	-	0.8	-	V _{CC} =3,600V, I _F =500A, L=200nH T _j =125°C R _G =12Ω(3)
Reverse Recovery Loss	E _{rr(10%)}	J/P	-	1.65	2.1	
		E _{rr(full)}	J/P	-	1.8	-

PACKAGE CHARACTERISTICS

Item	Symbol	Unit	Min.	Typ.	Max.	Test Conditions
Terminal Resistance	R _{CE}	mΩ	-	0.3	-	per arm
Terminal Stray Inductance	L _{sCE}	nH	-	42	-	per arm
Thermal Impedance	R _{th(j-c)}	K/W	-	-	0.026	Junction to case
Comparative tracking index	CTI		-	600	-	
Contact Thermal Impedance	R _{th(c-f)}	K/W	-	0.007	-	Case to f fin (λgrease=1W/(m·K), Heat-sink flatness ≤50μm)

Notes:(3) Counter arm; MDM500H65E2 V_{GE}=±15V

R_G value is the test condition's value for evaluation of the switching times, not recommended value.

Please, determine the suitable R_G value after the measurement of switching waveforms (overshoot voltage, etc.) with appliance mounted.

* Please contact our representatives at order.

* For improvement, specifications are subject to change without notice.

* For actual application, please confirm this spec sheet is the newest revision.

MDM500H65E2

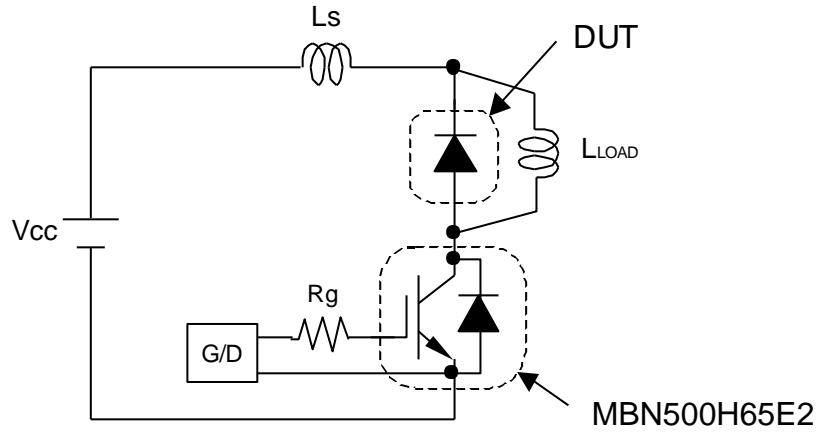

Fig.1 Switching test circuit

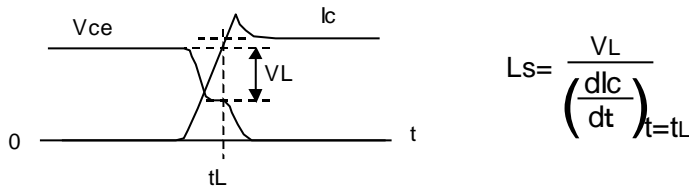
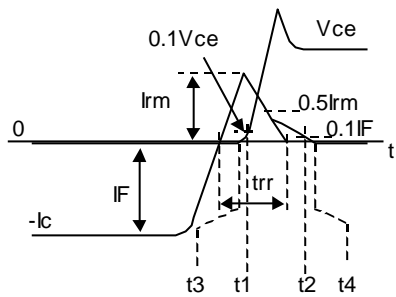

Fig.2 Definition of stray inductance



$$Err(10\%) = \int_{t1}^{t2} IF \cdot Vce dt$$

$$Err(Full) = \int_{t3}^{t4} IF \cdot Vce dt$$

Fig.3 Definition of switching loss

MDM500H65E2

STATIC CHARACTERISTICS

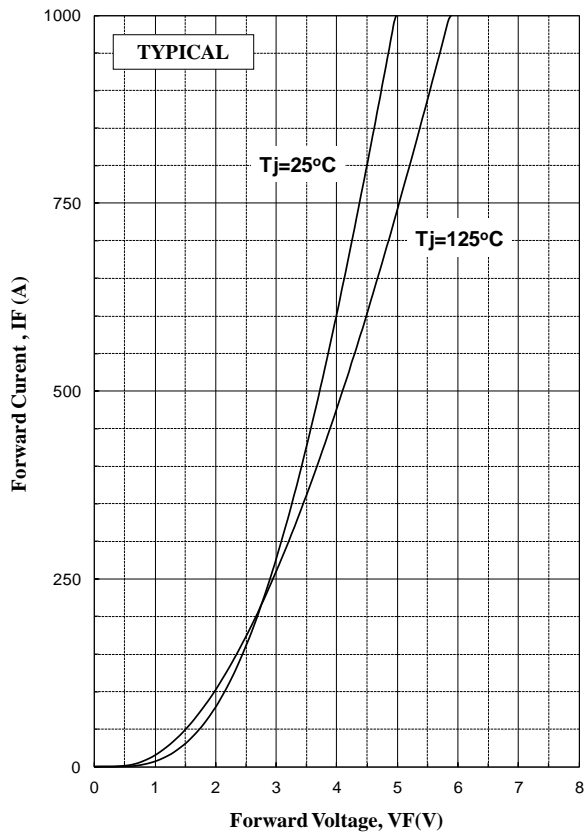

DYNAMIC CHARACTERISTICS

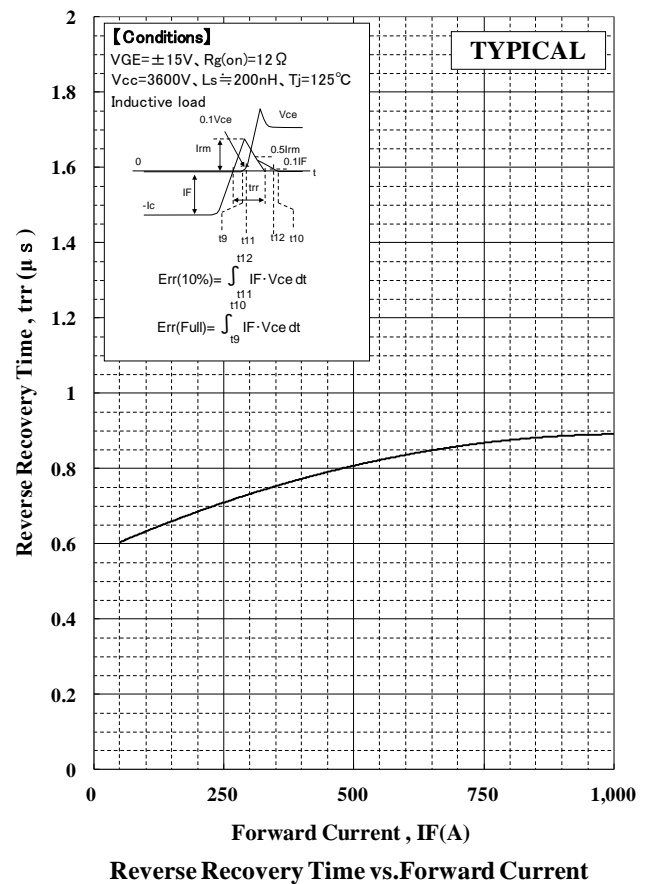
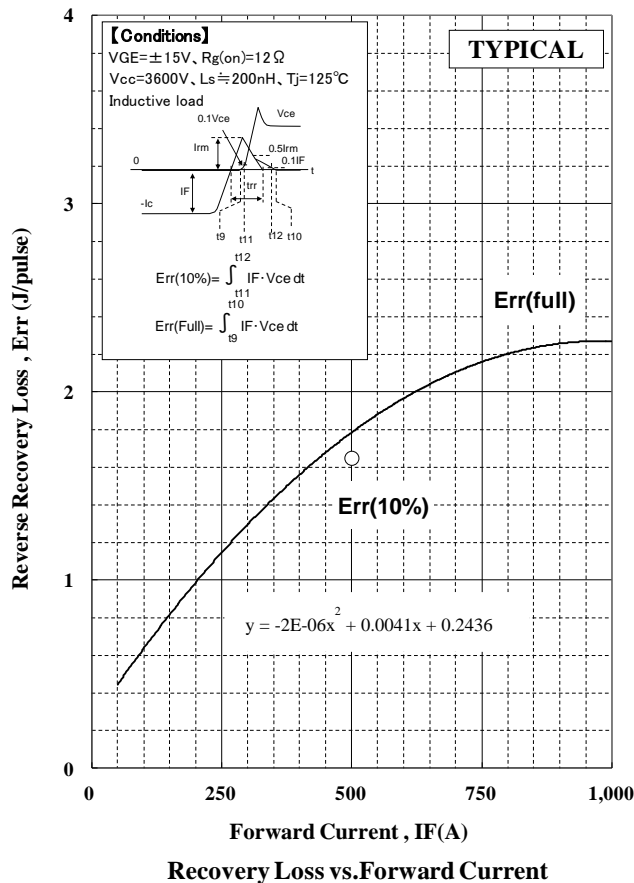

MDM500H65E2

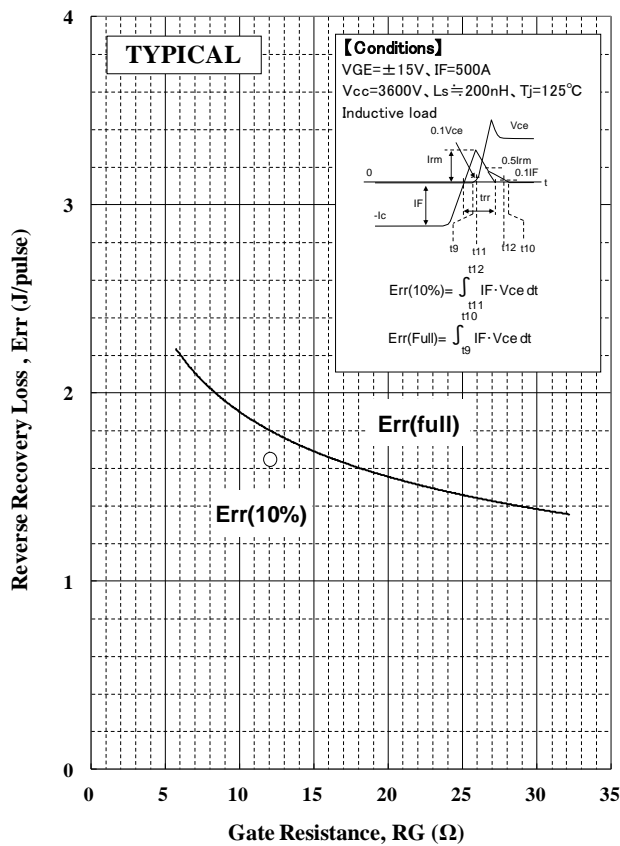

Recovery Loss vs. Gate Resistance

RecSOA

Conditions:
 Ls≤200nH, Vcc≤4400V, IF≤1000A, VGE=-15V,
 Rg(on) of across IGBT ≥12Ω, VGE of across IGBT =±15V,
 -40°C≤Tc≤125°C, Conduction pulse width of diode ≥30μs

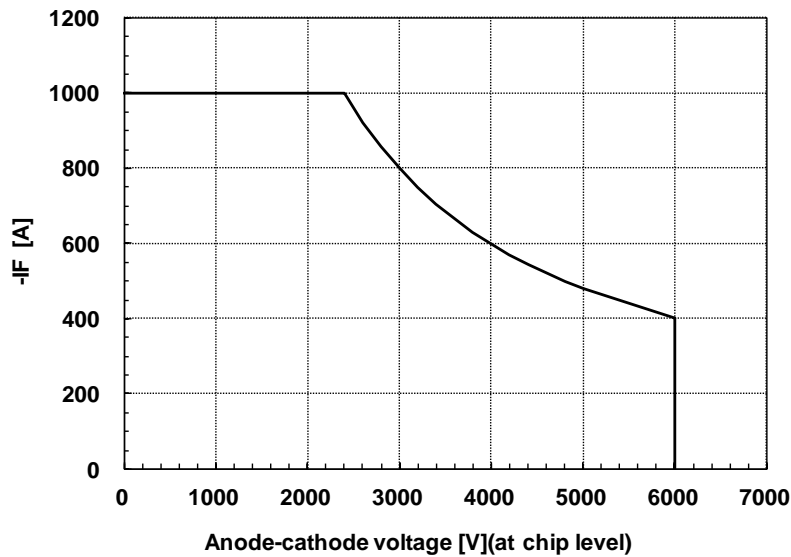

RecSOA

MDM500H65E2

TRANSIENT THERMAL IMPEDANCE

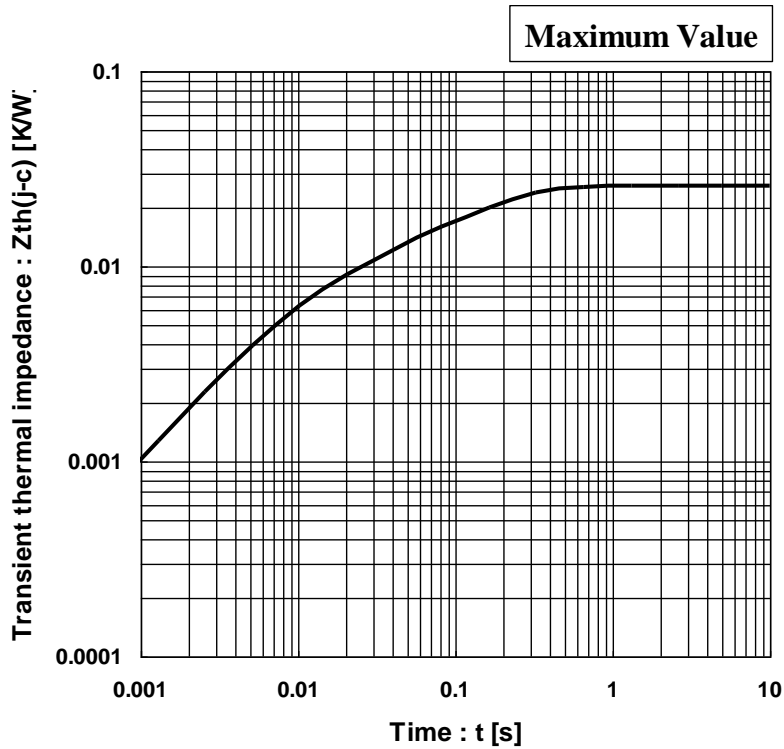

Transient Thermal Impedance Curve

Curve approximation model
 $Z_{th} = \sum r_{th}[n] \cdot (1 - \exp(-t/r_{th}[n]))$

n	1	2	3	4	Unit
$\tau_{th}[n]$	1.64E-01	2.88E-02	6.99E-03	9.33E-04	sec
$r_{th}[n,IGBT]$	1.61E-02	5.01E-03	4.65E-03	1.98E-04	K/W

MDM500H65E2

OUTLINE DRAWING

Unit in mm

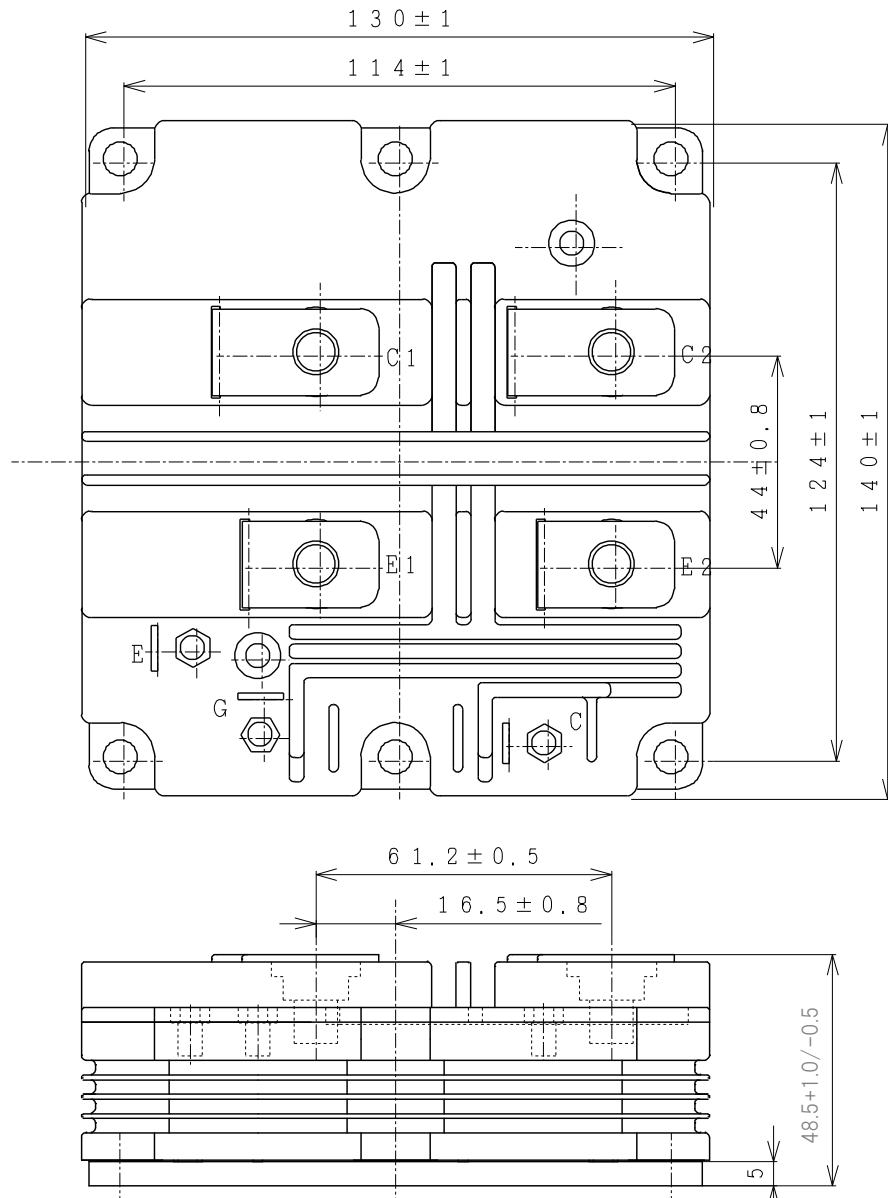

Weight: 1050(g)

Material declaration

Please note the following materials are contained in the product, in order to keep product characteristic and reliability level.

Material	Contained part
Lead (Pb) and its compounds	Solder

MDM500H65E2

HITACHI POWER SEMICONDUCTORS

Notices

1. The information given herein, including the specifications and dimensions, is subject to change without prior notice to improve product characteristics. Before ordering, purchasers are advised to contact Hitachi sales department for the latest version of this data sheets.
2. Please be sure to read "Precautions for Safe Use and Notices" in the individual brochure before use.
3. In cases where extremely high reliability is required (such as use in nuclear power control, aerospace and aviation, traffic equipment, life-support-related medical equipment, fuel control equipment and various kinds of safety equipment), safety should be ensured by using semiconductor devices that feature assured safety or by means of users' fail-safe precautions or other arrangement. Or consult Hitachi's sales department staff.
4. In no event shall Hitachi be liable for any damages that may result from an accident or any other cause during operation of the user's units according to this data sheets. Hitachi assumes no responsibility for any intellectual property claims or any other problems that may result from applications of information, products or circuits described in this data sheets.
5. In no event shall Hitachi be liable for any failure in a semiconductor device or any secondary damage resulting from use at a value exceeding the absolute maximum rating.
6. No license is granted by this data sheets under any patents or other rights of any third party or Hitachi, Ltd.
7. This data sheets may not be reproduced or duplicated, in any form, in whole or in part, without the expressed written permission of Hitachi, Ltd.
8. The products (technologies) described in this data sheets are not to be provided to any party whose purpose in their application will hinder maintenance of international peace and safety not are they to be applied to that purpose by their direct purchasers or any third party. When exporting these products (technologies), the necessary procedures are to be taken in accordance with related laws and regulations.

- For inquiries relating to the products, please contact nearest overseas representatives that is located "Inquiry" portion on the top page of a home page.

Hitachi power semiconductor home page address <http://www.hitachi.co.jp/products/power/pse/>