

# MBM500E33E2-R

Silicon N-channel IGBT 3300V E2 version

## FEATURES

- \* Soft switching behavior & low conduction loss:  
Soft low-injection punch-through High conductivity IGBT.
- \* Low driving power due to low input capacitance MOS gate.
- \* Low noise recovery: Ultra soft fast recovery diode.
- \* High thermal fatigue durability:  
( $\Delta T_c=70K$ ,  $N>30,000$ cycles)  
AlSiC base-plate/AlN substrate

## ABSOLUTE MAXIMUM RATINGS ( $T_c=25^\circ C$ )

Item	Symbol	Unit	MBM500E33E2-R
Collector Emitter Voltage	$V_{CES}$	V	3,300
Gate Emitter Voltage	$V_{GES}$	V	$\pm 20$
Collector Current	DC	$I_c$	500 ( $T_c=95^\circ C$ )
	1ms	$I_{cp}$	1,000
Forward Current	DC	$I_F$	500
	1ms	$I_{FM}$	1,000
Operating Junction Temperature	$T_{vj,op}$	$^\circ C$	-50 ~ +150
Maximum Junction Temperature	$T_{vj,max}$	$^\circ C$	175 (1)
Storage Temperature	$T_{stg}$	$^\circ C$	-55 ~ +125
Isolation Voltage	$V_{ISO}$	$V_{RMS}$	6,000(AC 1 minute)
Screw Torque	Terminals (M4/M8)	-	2/15 (2)
	Mounting (M6)	-	6 (3)

Notes: (1) Only static operation is applicable. Please refer to LD-ES-130737.

(2) Recommended Value  $1.8 \pm 0.2/15^{+0.3} N \cdot m$ (3) Recommended Value  $5.5 \pm 0.5 N \cdot m$ 

## ELECTRICAL CHARACTERISTICS

Item	Symbol	Unit	Min.	Typ.	Max.	Test Conditions
Collector Emitter Cut-Off Current	$I_{CES}$	mA	-	-	4	$V_{CE}=3,300V, V_{GE}=0V, T_j=25^\circ C$
			-	7	20	$V_{CE}=3,300V, V_{GE}=0V, T_j=125^\circ C$
Gate Emitter Leakage Current	$I_{GES}$	nA	-500	-	+500	$V_{GE}=\pm 20V, V_{CE}=0V, T_j=25^\circ C$
Collector Emitter Saturation Voltage	$V_{CE(sat)}$	V	2.5	2.95	3.5	$I_c=500A, V_{GE}=15V, T_j=125^\circ C$
			-	3.1	-	$I_c=500A, V_{GE}=15V, T_j=150^\circ C$
Gate Emitter Threshold Voltage	$V_{GE(To)}$	V	5.5	6.5	7.5	$V_{CE}=10V, I_c=500mA, T_j=25^\circ C$
Input Capacitance	$C_{ies}$	nF	-	65	-	$V_{CE}=10V, V_{GE}=0V, f=100kHz, T_j=25^\circ C$
Internal Gate Resistance	$R_{ge}$	$\Omega$	-	2.1	-	$V_{CE}=10V, V_{GE}=0V, f=100kHz, T_j=25^\circ C$
Switching Times	Rise Time	$t_r$	0.8	1.3	1.8	$V_{CC}=1,650V, I_c=500A$
	Turn On Time	$t_{on}$	0.7	1.7	2.1	$L_s=150nH$
	Fall Time	$t_f$	0.9	1.7	2.6	$R_G(on/off)=5.6\Omega/8.2\Omega$ (4)
	Turn Off Time	$t_{off}$	2.1	3.8	4.9	$V_{GE}=\pm 15V, T_j=125^\circ C$
Peak Forward Voltage Drop	$V_{FM}$	V	2.2	2.5	3.0	$I_F=500A, V_{GE}=0V, T_j=125^\circ C$
			-	2.5	-	$I_F=500A, V_{GE}=0V, T_j=150^\circ C$
Reverse Recovery Time	$t_{rr}$	$\mu s$	-	0.60	0.87	$V_{CC}=1,650V, I_F=500A, L_s=150nH$ $T_j=125^\circ C, R_G(on)=5.6\Omega, V_{GE}=\pm 15V$
Short Circuit Pulse Width	$t_{sc}$	$\mu s$	10	-	-	$V_{CC}=2200V, L_s=130nH$ $R_G(on/off)=5.6/8.2\Omega, V_{GE}=\pm 15V, T_j=150^\circ C$
Turn On Loss	$E_{on(10\%)}$	J/P	-	0.65	0.95	$T_j=125^\circ C$
	$E_{on(full)}$		-	0.70	-	$T_j=150^\circ C$
Turn Off Loss	$E_{off(10\%)}$	J/P	-	0.72	0.86	$T_j=125^\circ C$
	$E_{off(full)}$		-	0.79	-	$T_j=150^\circ C$
Reverse Recovery Loss	$E_{rr(10\%)}$	J/P	-	0.66	0.80	$T_j=125^\circ C$
	$E_{rr(full)}$		-	0.78	-	$T_j=150^\circ C$

Notes:(4)  $R_G$  is the test condition's value for evaluation of the switching times, not recommended value. Please, determine the suitable  $R_G$  value after the measurement of switching waveforms(overshoot voltage, etc.) with appliance mounted.

\* Please contact our representatives at order.

\* For improvement, specifications are subject to change without notice.

\* For actual application, please confirm this spec sheet is the newest revision.

# MBM500E33E2-R

## THERMAL CHARACTERISTICS

Item		Symbol	Unit	Min.	Typ.	Max.	Test Conditions
Thermal Impedance	IGBT	Rth(j-c)	K/W	-	-	0.024	Junction to case
	FWD	Rth(j-c)		-	-	0.049	
Contact Thermal Impedance		Rth(c-f)	K/W	-	0.008	-	Case to fin ( $\lambda_{grease}=1W/(m \cdot K)$ , heat-sink flatness $\leq 50\mu m$ )

## MODULE MECHANICAL CHARACTERISTICS

Item		Unit	Characteristics	Conditions
Weight		g	900	
Creepage Distance	Between terminal	mm	>34	E2aux-C2aux
	Terminal-Base	mm	>32	Base-E1aux
Clearance Distance	Between terminal	mm	>19	C1main-E1aux
	Terminal-Base	mm	>28	Base-E1aux
Stray inductance in module		nH	36	Collector-main to Emitter-main
Comparative Tracking Index (CTI)			600	
Module base plate Material			Al-SiC	
Baseplate Thickness		mm	5	
Insulation plate Material			AlN	
Terminal Surface treatment			Ni plating	
Case Material			Poly-Phenylene Sulfide	
Fire and Smoke Category			I2 / F3	NFF 16-102

# MBM500E33E2-R

## DEFINITION OF TEST CIRCUIT

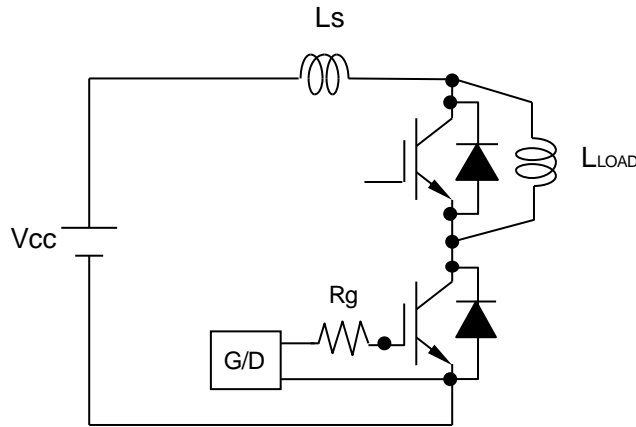

Fig.1 Switching test circuit

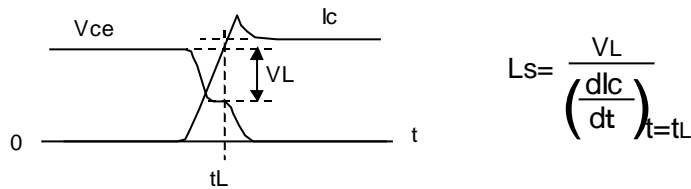

Fig.2 Definition of stray inductance

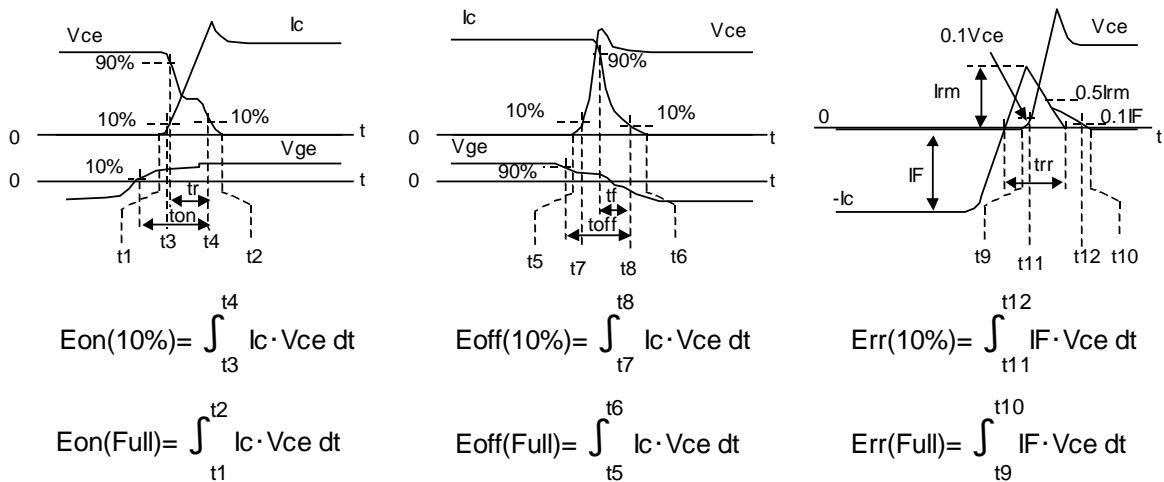
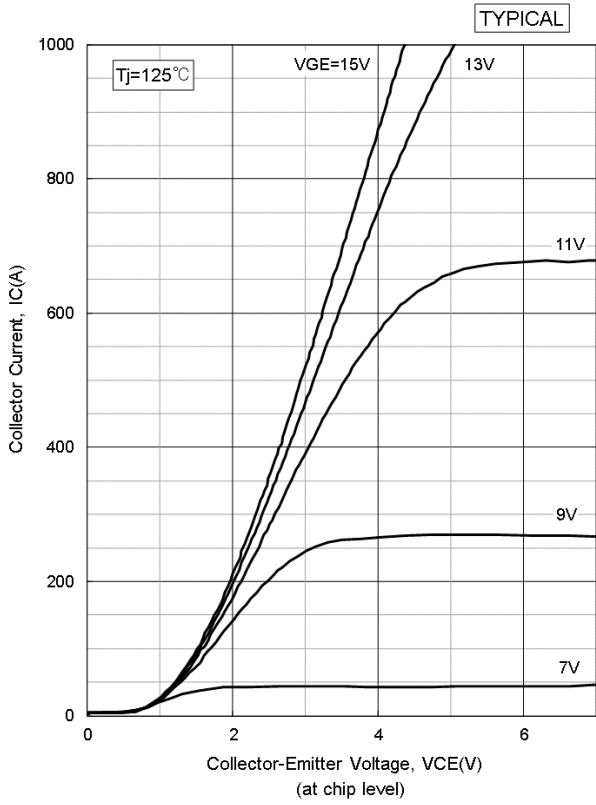

Fig.3 Definition of switching loss

# MBM500E33E2-R

## STATIC CHARACTERISTICS



IC vs. VCE

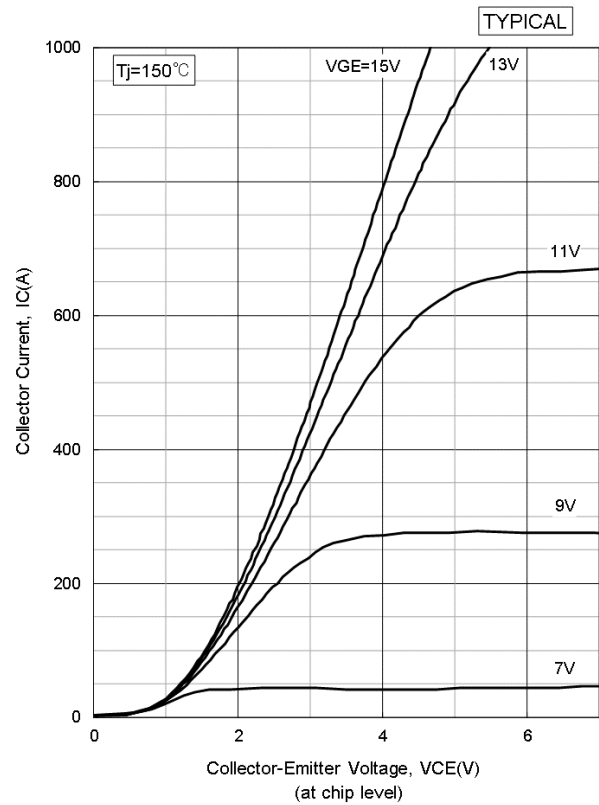

IC vs. VCE

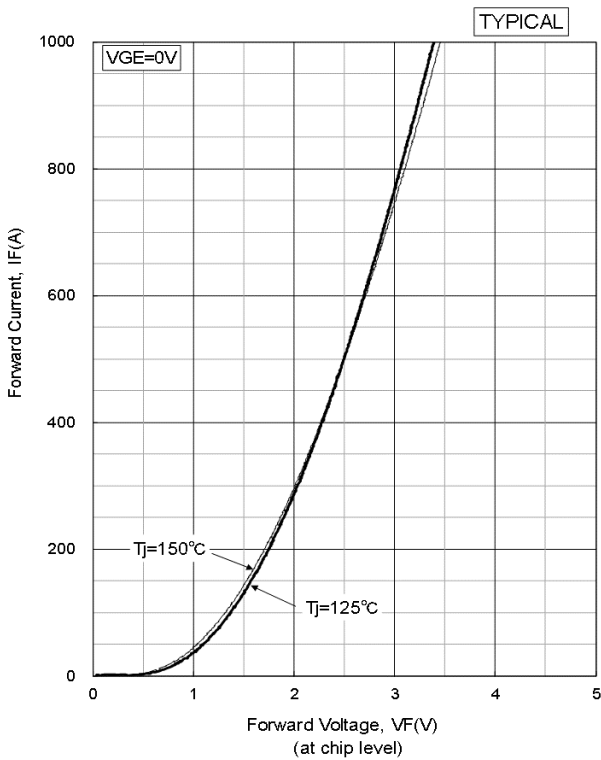

IF vs. VF

# MBM500E33E2-R

## DYNAMIC CHARACTERISTICS

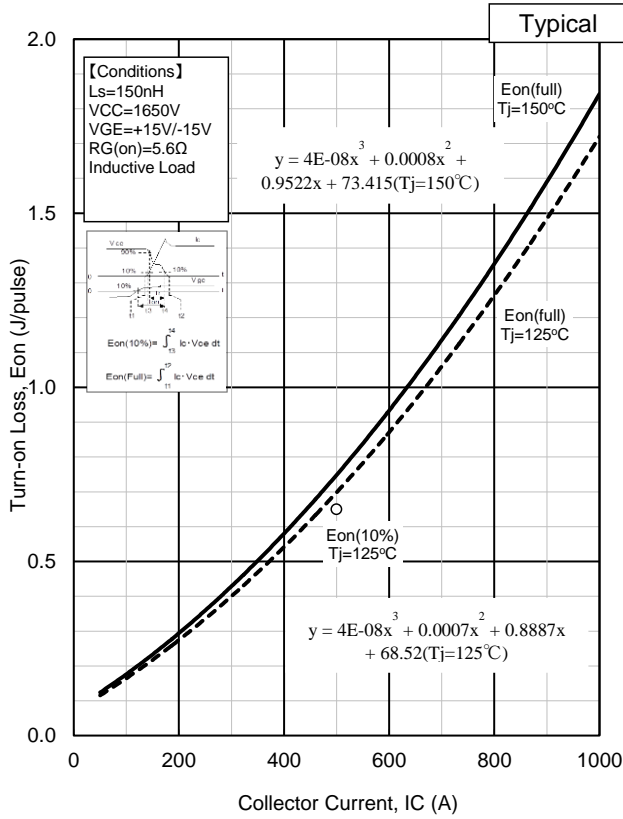

Turn-on loss vs. Collector current

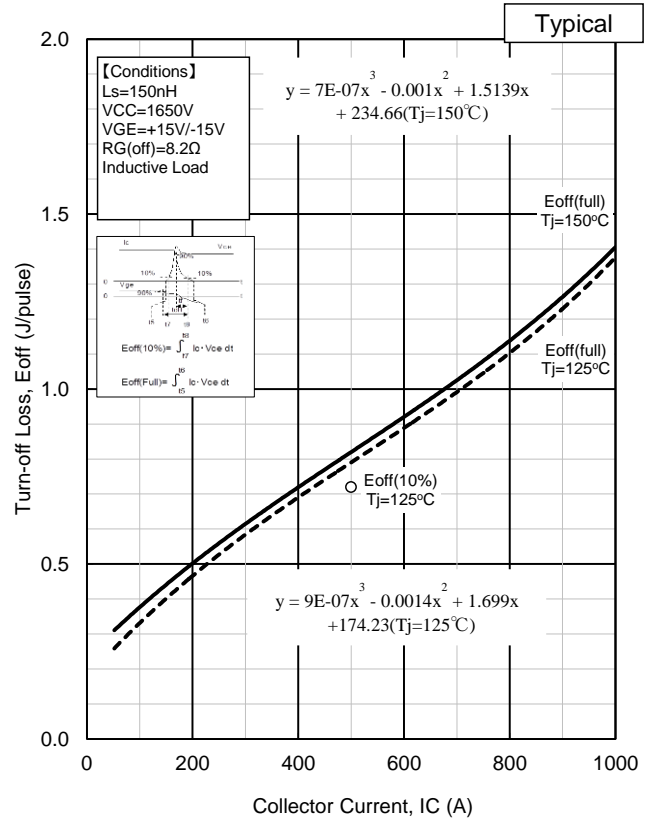

Turn-off loss vs. Collector current

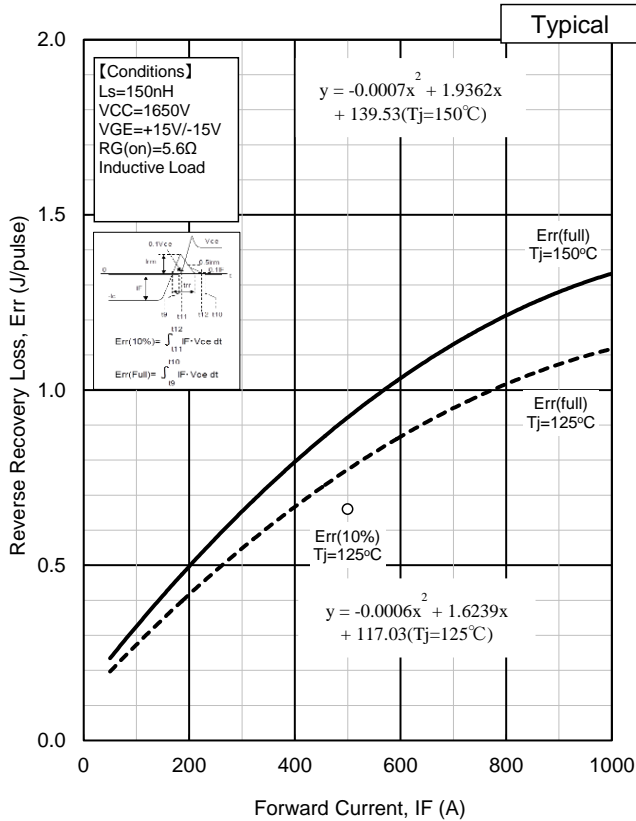

Recovery loss vs. Forward current

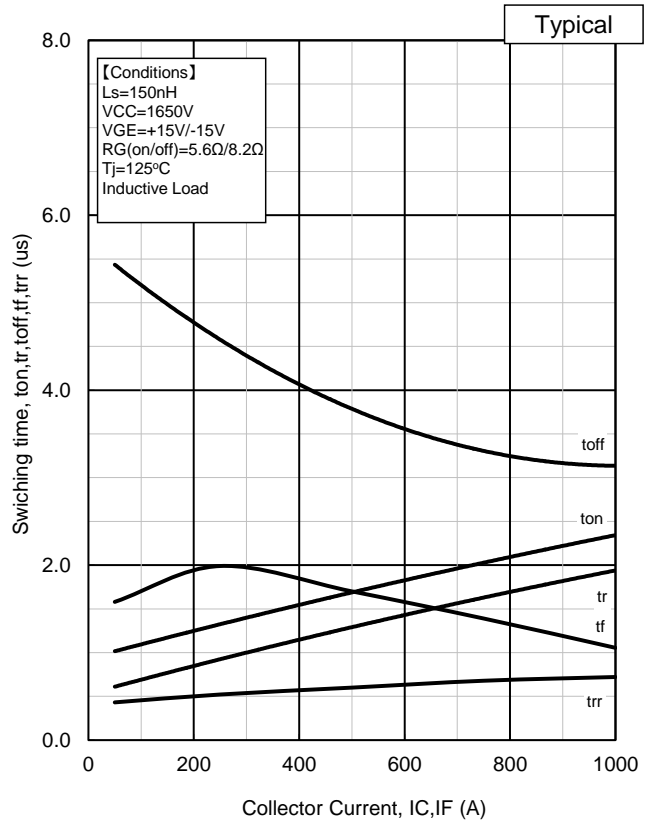

Switching time vs. Collector current

# MBM500E33E2-R

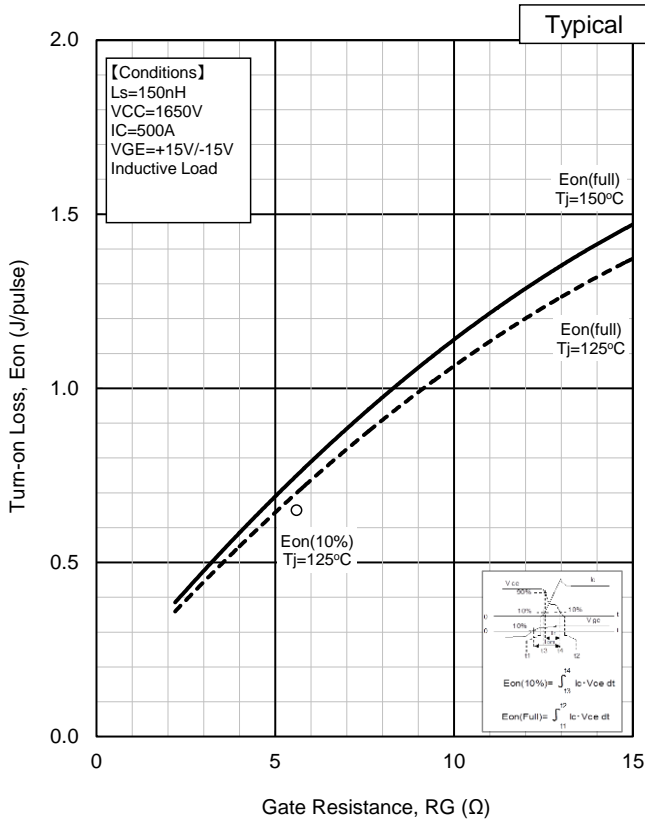

Turn-on loss vs. Gate Resistance

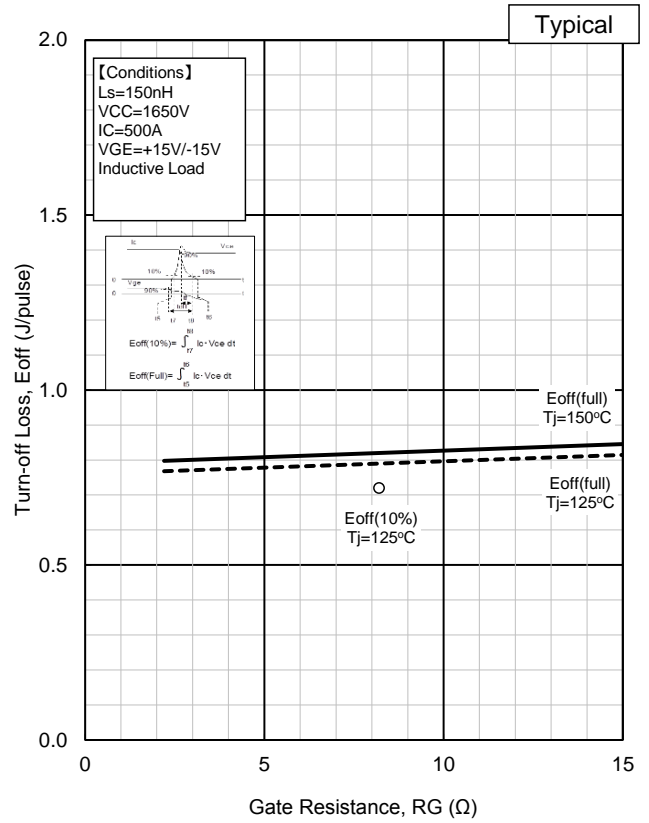

Turn-off loss vs. Gate Resistance

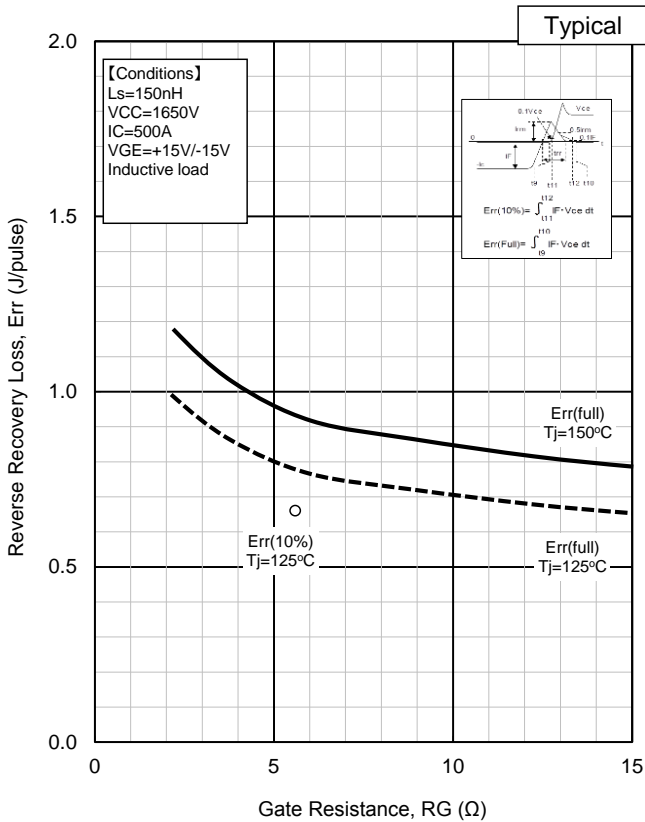

Recovery loss vs. Gate Resistance

# MBM500E33E2-R

QG-VG Curve

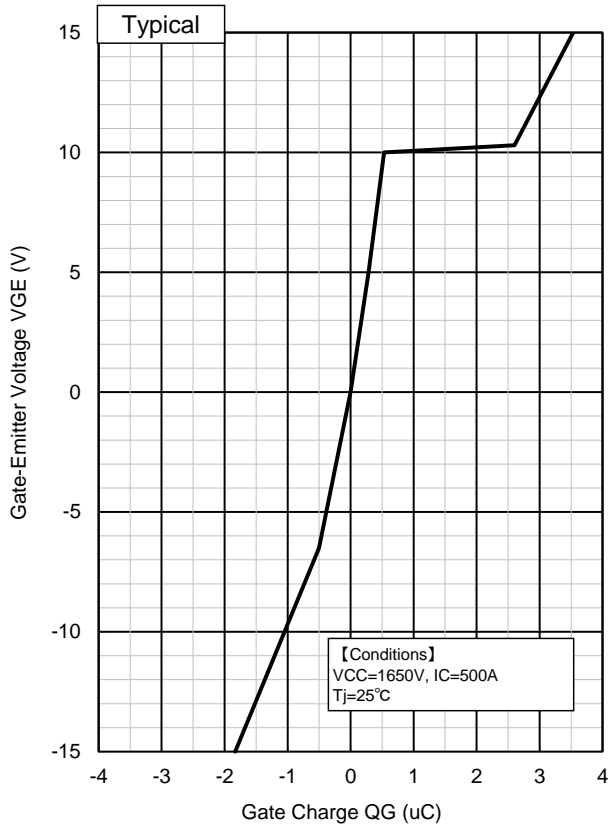

QG vs. VGE

Cies, Coes, Cres curve

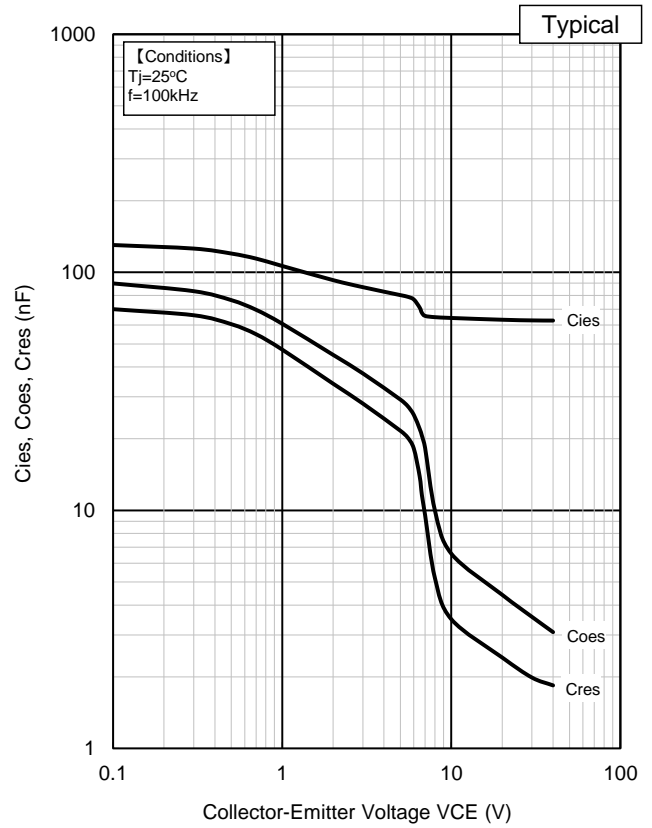

Cies, Coes, Cres vs. VCE

Safe Operation Area

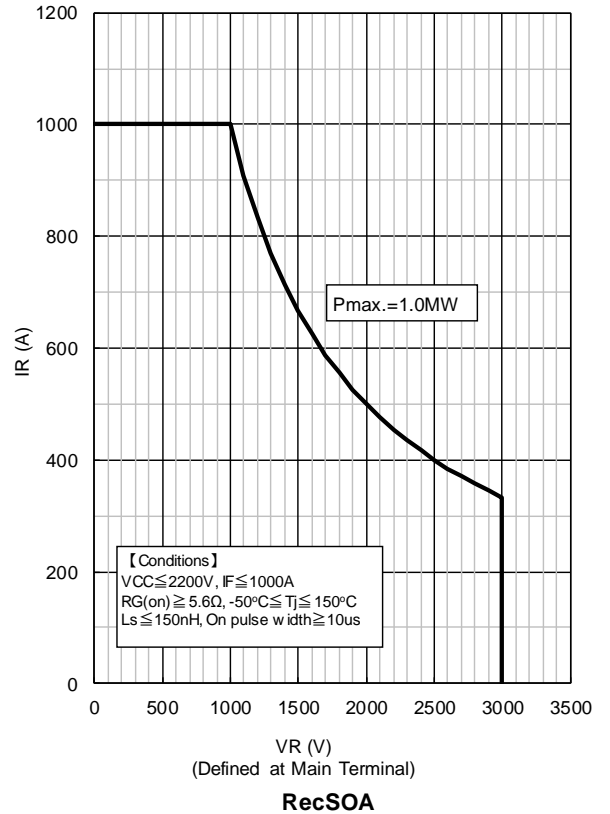
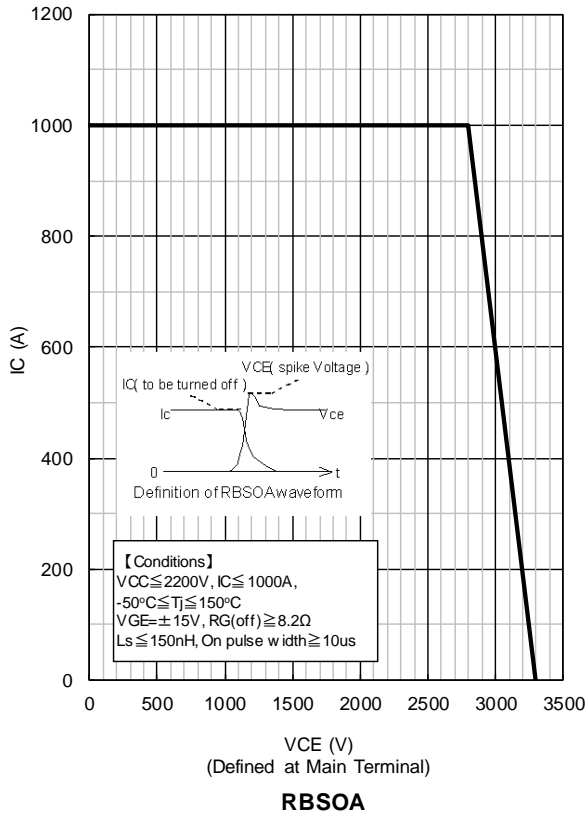

# MBM500E33E2-R

## OUTLINE DRAWINGS

Unit in mm

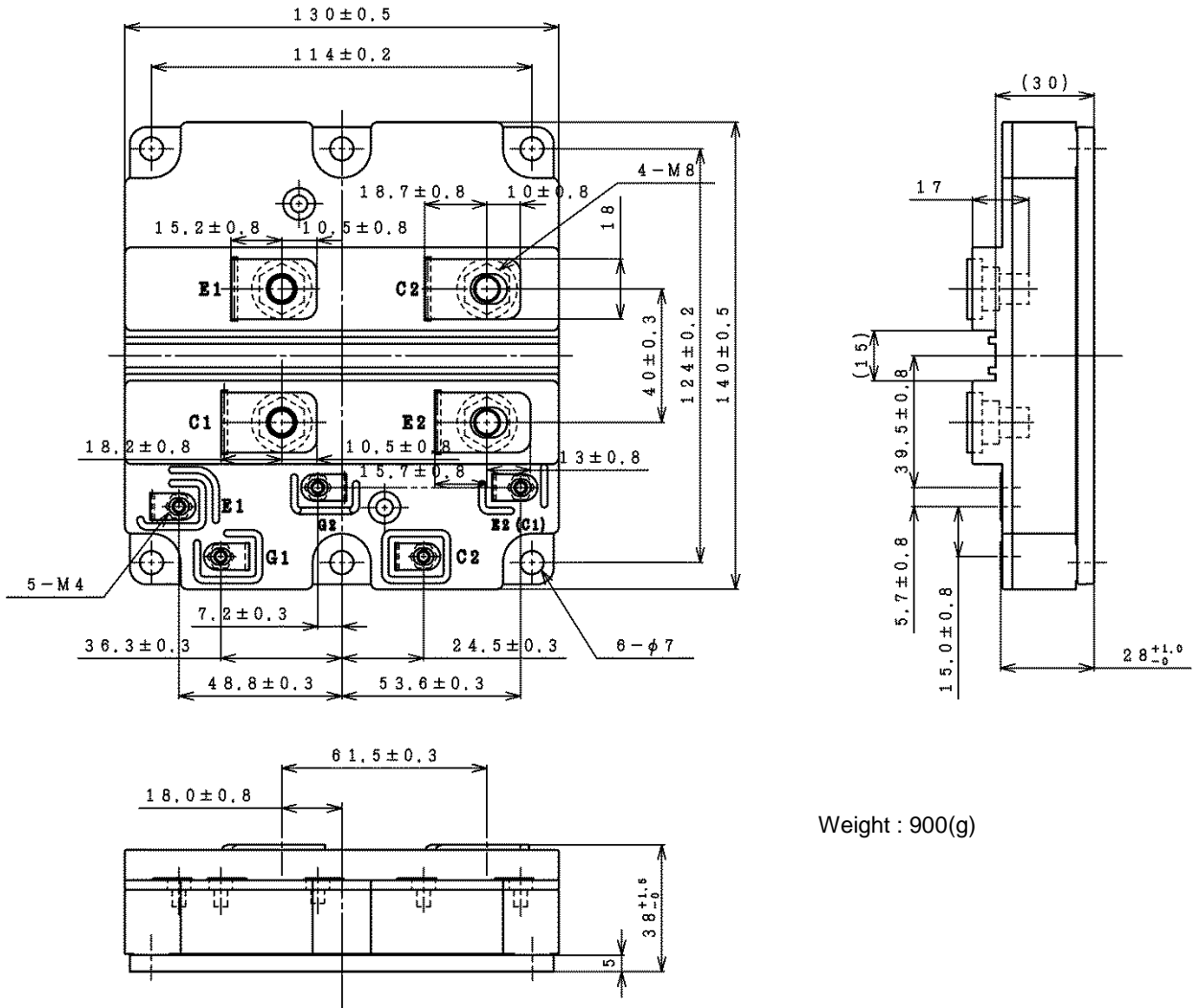

Weight : 900(g)

## CIRCUIT DIAGRAM

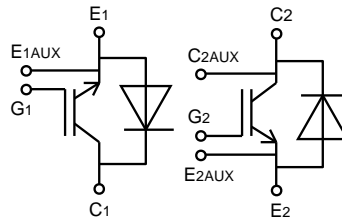

## Material declaration

Please note the following materials are contained in the product, in order to keep characteristic and reliability level.

Material	Contained part
Lead (Pb) and its compounds	Solder



# MBM500E33E2-R

TRANSIENT THERMAL IMPEDANCE

**Maximum**

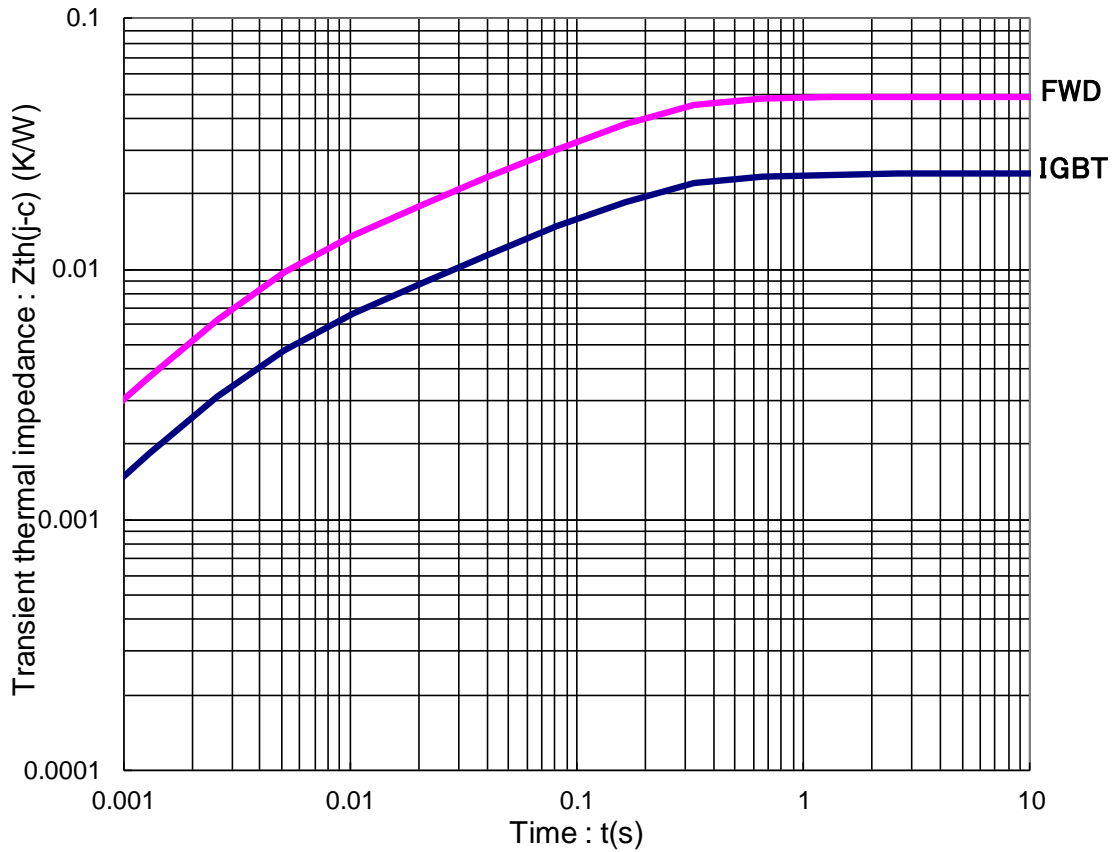

**Transient Thermal Impedance Curve**

Curve approximation model

$$(\sum R_{th}[n] * (1 - \exp(-t/\tau_{th}[n])))$$

n	1	2	3	4	Unit
$\tau_{th}[n]$	1.60E-01	2.77E-02	4.10E-03	8.07E-04	sec
$R_{th}[n,IGBT]$	1.49E-02	4.33E-03	4.28E-03	5.03E-04	K/W
$R_{th}[n,Diode]$	3.02E-02	9.24E-03	8.50E-03	1.06E-03	K/W

# MBM500E33E2-R

## HITACHI POWER SEMICONDUCTORS

### Notices

1. The information given herein, including the specifications and dimensions, is subject to change without prior notice to improve product characteristics. Before ordering, purchasers are advised to contact Hitachi sales department for the latest version of this data sheets.
2. Please be sure to read "Precautions for Safe Use and Notices" in the individual brochure before use.
3. In cases where extremely high reliability is required (such as use in nuclear power control, aerospace and aviation, traffic equipment, life-support-related medical equipment, fuel control equipment and various kinds of safety equipment), safety should be ensured by using semiconductor devices that feature assured safety or by means of users' fail-safe precautions or other arrangement. Or consult Hitachi's sales department staff.
4. In no event shall Hitachi be liable for any damages that may result from an accident or any other cause during operation of the user's units according to this data sheets. Hitachi assumes no responsibility for any intellectual property claims or any other problems that may result from applications of information, products or circuits described in this data sheets.
5. In no event shall Hitachi be liable for any failure in a semiconductor device or any secondary damage resulting from use at a value exceeding the absolute maximum rating.
6. No license is granted by this data sheets under any patents or other rights of any third party or Hitachi Power Semiconductor Device, Ltd.
7. This data sheets may not be reproduced or duplicated, in any form, in whole or in part, without the expressed written permission of Hitachi Power Semiconductor Device, Ltd.
8. The products (technologies) described in this data sheets are not to be provided to any party whose purpose in their application will hinder maintenance of international peace and safety not are they to be applied to that purpose by their direct purchasers or any third party. When exporting these products (technologies), the necessary procedures are to be taken in accordance with related laws and regulations.

- 
- For inquiries relating to the products, please contact nearest overseas representatives that is located "Inquiry" portion on the top page of a home page.
- 

Hitachi power semiconductor home page address <http://www.hitachi-power-semiconductor-device.co.jp/en/>