

MBM300GS6AW

Silicon N-channel IGBT

OUTLINE DRAWING

FEATURES

- * High speed and low saturation voltage.
- * low noise due to built-in free-wheeling diode - ultra soft fast recovery diode(USFD).
- * Isolated head sink (terminal to base).

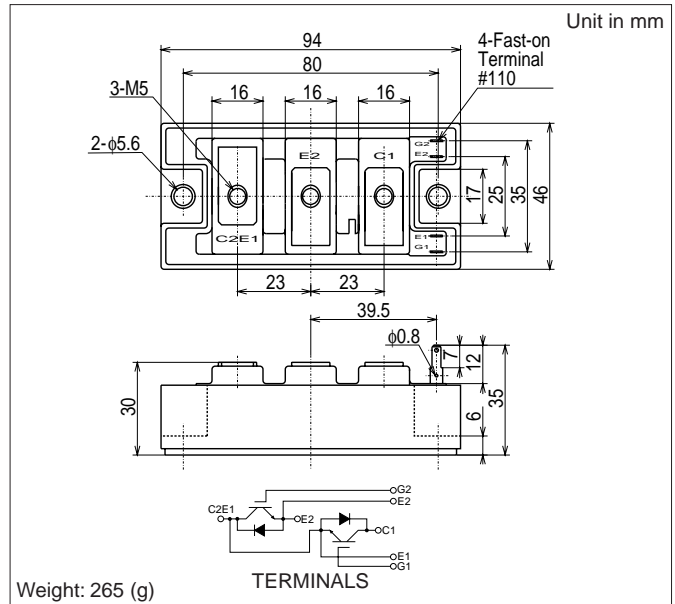

ABSOLUTE MAXIMUM RATINGS (T_c=25°C)

Item	Symbol	Unit	MBM300GS6AW
Collector Emitter Voltage	V _{CES}	V	600
Gate Emitter Voltage	V _{GES}	V	±20
Collector Current	DC	I _c	300
	1ms	I _{cp}	600
Forward Current	DC	I _F	300 (1)
	1ms	I _{FM}	600
Collector Power Dissipation	P _c	W	800
Junction Temperature	T _j	°C	-40 ~ +150
Storage Temperature	T _{stg}	°C	-40 ~ +125
Isolation Voltage	V _{ISO}	V _{RMS}	2,500(AC 1 minute)
Screw Torque	Terminals	-	1.96(20) (2)
	Mounting	-	1.96(20) (3)

Notes:(1)RMS Current of Diode 90Arms max.

(2)(3)Recommended Value 1.67N.m(17kgf.cm)

CHARACTERISTICS (T_c=25°C)

Item	Symbol	Unit	Min.	Typ.	Max.	Test Conditions	
Collector Emitter Cut-Off Current	I _{CES}	mA	-	-	1.0	V _{CE} =600V, V _{GE} =0V	
Gate Emitter Leakage Current	I _{GES}	nA	-	-	±500	V _{GE} =±20V, V _{CE} =0V	
Collector Emitter Saturation Voltage	V _{CE(sat)}	V	-	1.9	2.5	I _c =300A, V _{GE} =15V	
Gate Emitter Threshold Voltage	V _{GE(TO)}	V	-	-	10	V _{CE} =5V, I _c =300mA	
Input Capacitance	C _{ies}	pF	-	15,000	-	V _{CE} =10V, V _{GE} =0V, f=1MHz	
Switching Times	Rise Time	t _r	-	0.25	0.5	V _{CC} =300V R _L =1.0Ω R _G =8.2Ω (4) V _{GE} =±15V	
	Turn On Time	t _{on}	-	0.35	0.7		
	Fall Time	t _f	-	0.25	0.35		
	Turn Off Time	t _{off}	-	0.8	1.1		
Peak Forward Voltage Drop	V _{FM}	V	-	2.2	3.0	I _F =300A, V _{GE} =0V	
Reverse Recovery Time	t _{rr}	μs	-	-	0.3	I _F =300A, V _{GE} =-10V, di/dt=300A/μs	
Thermal Impedance	IGBT	R _{th(j-c)}	°C/W	-	-	0.156	Junction to case
	FWD	R _{th(j-c)}	°C/W	-	-	0.28	

Notes:(4) R_G value is the test condition's value for decision of the switching times, not recommended value.Determine the suitable R_G value after the measurement of switching waveforms (overshoot voltage, etc.) with appliance mounted.

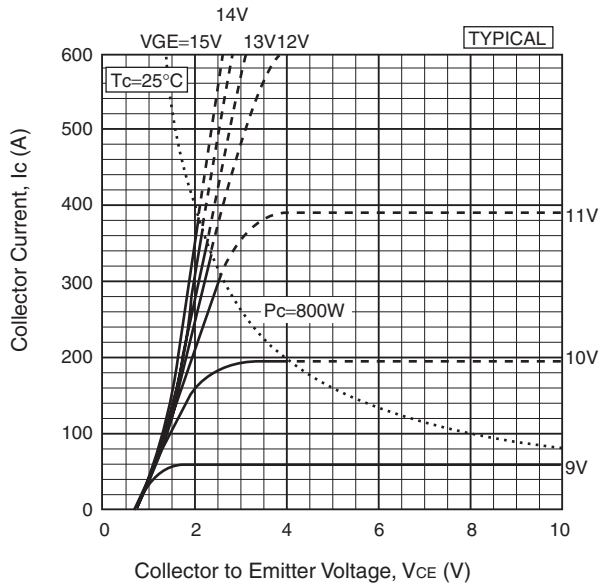

Collector current vs. Collector to Emitter voltage

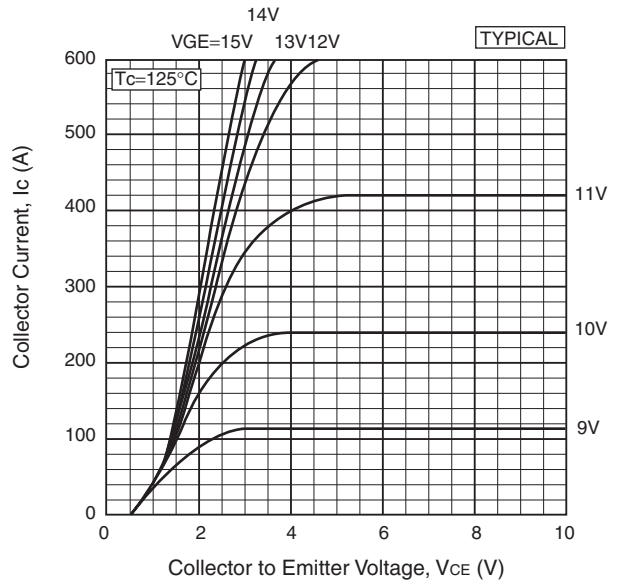

Collector current vs. Collector to Emitter voltage

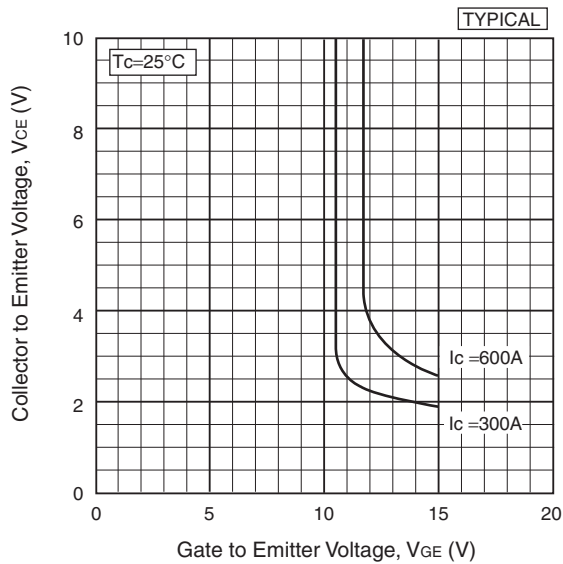

Collector to Emitter voltage vs. Gate to Emitter voltage

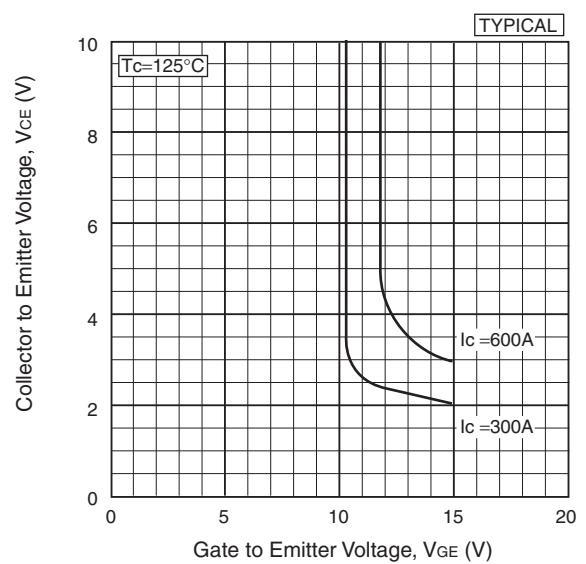

Collector to Emitter voltage vs. Gate to Emitter voltage

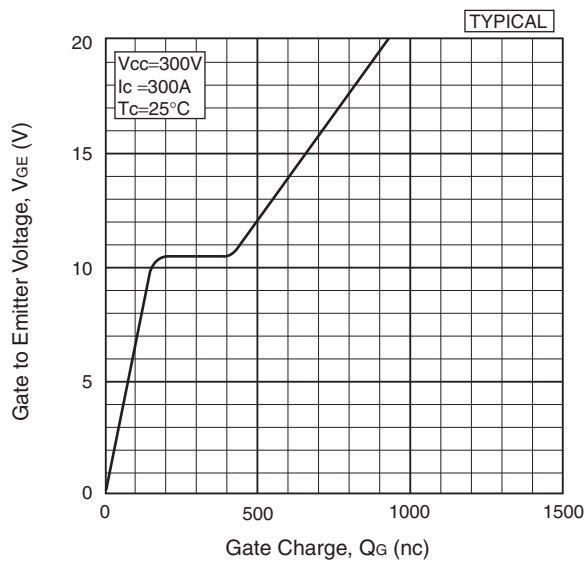

Gate charge characteristics

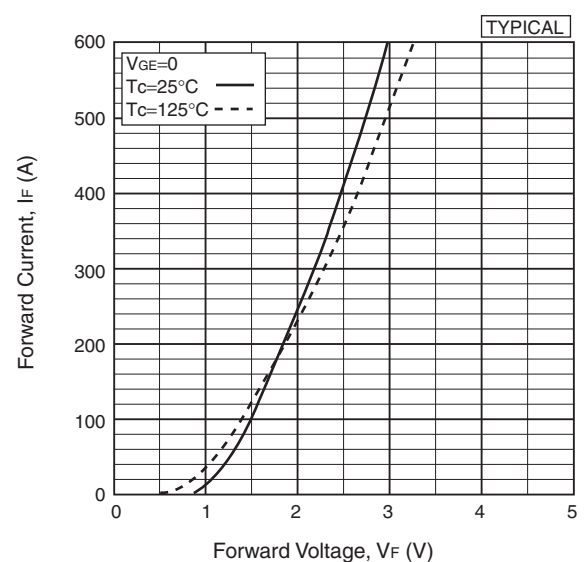

Forward voltage of free-wheeling diode

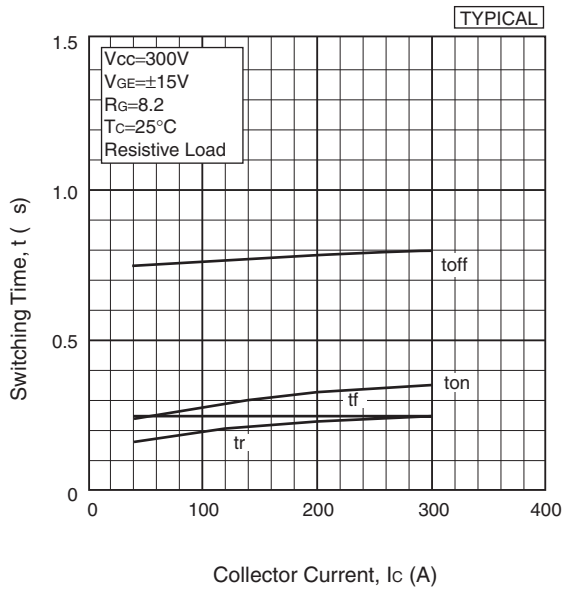

Switching time vs. Collector current

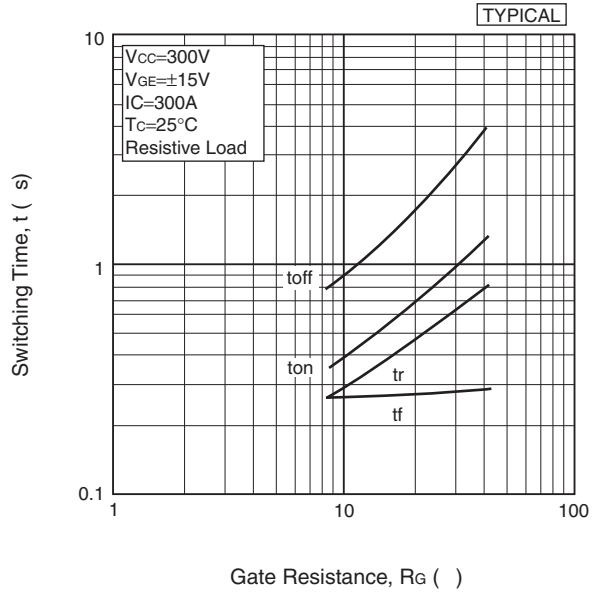

Switching time vs. Gate resistance

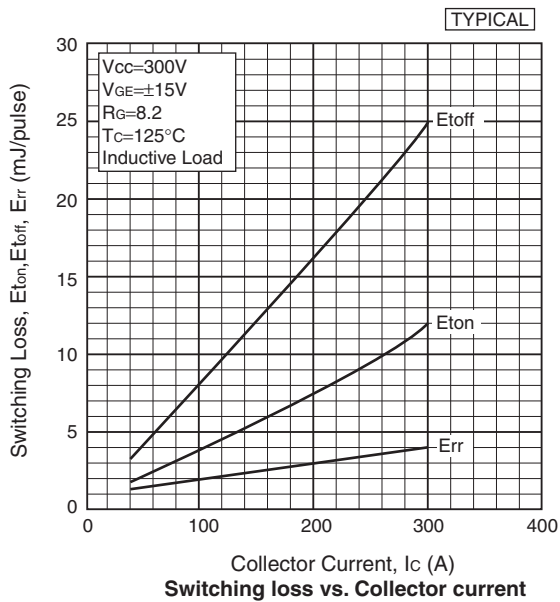

Switching loss vs. Collector current

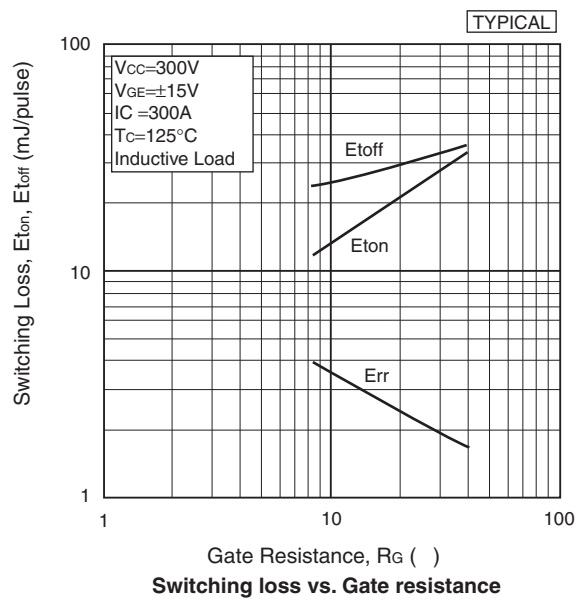

Switching loss vs. Gate resistance

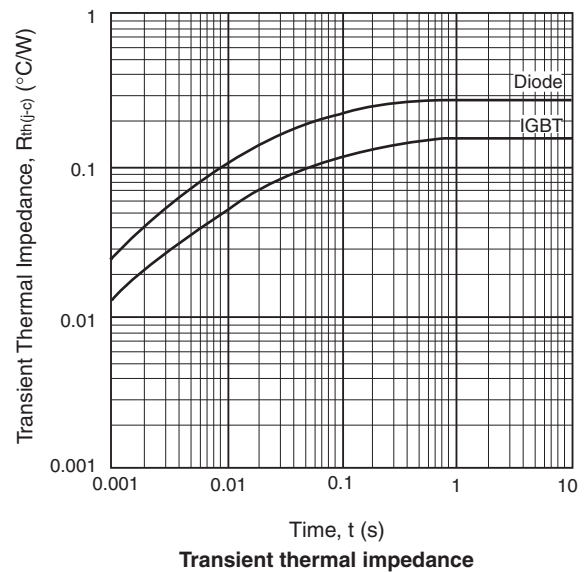
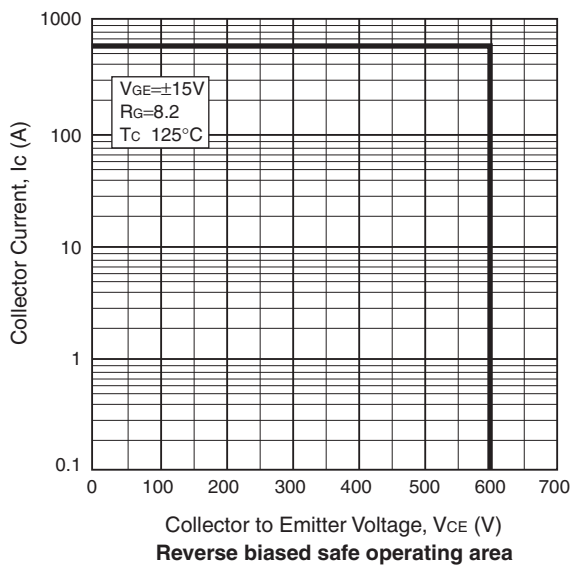

HITACHI POWER SEMICONDUCTORS

Notices

- 1.The information given herein, including the specifications and dimensions, is subject to change without prior notice to improve product characteristics. Before ordering, purchasers are advised to contact Hitachi sales department for the latest version of this data sheets.
- 2.Please be sure to read "Precautions for Safe Use and Notices" in the individual brochure before use.
- 3.In cases where extremely high reliability is required(such as use in nuclear power control, aerospace and aviation, traffic equipment, life-support-related medical equipment, fuel control equipment and various kinds of safety equipment), safety should be ensured by using semiconductor devices that feature assured safety or by means of users' fail-safe precautions or other arrangement. Or consult Hitachi's sales department staff.
- 4.In no event shall Hitachi be liable for any damages that may result from an accident or any other cause during operation of the user's units according to this data sheets. Hitachi assumes no responsibility for any intellectual property claims or any other problems that may result from applications of information, products or circuits described in this data sheets.
- 5.In no event shall Hitachi be liable for any failure in a semiconductor device or any secondary damage resulting from use at a value exceeding the absolute maximum rating.
- 6.No license is granted by this data sheets under any patents or other rights of any third party or Hitachi, Ltd.
- 7.This data sheets may not be reproduced or duplicated, in any form, in whole or in part , without the expressed written permission of Hitachi, Ltd.
- 8.The products (technologies) described in this data sheets are not to be provided to any party whose purpose in their application will hinder maintenance of international peace and safety not are they to be applied to that purpose by their direct purchasers or any third party. When exporting these products (technologies), the necessary procedures are to be taken in accordance with related laws and regulations.

-
- For inquiries relating to the products, please contact nearest overseas representatives which is located "Inquiry" portion on the top page of a home page.
-

Hitachi power semiconductor home page address <http://www.hitachi.co.jp/pse>

HITACHI