

MBB500TX7B

Preliminary Specification

Silicon N-channel IGBT

1. FEATURES

- * High speed, low loss IGBT module.
- * Low driving power:
Low input capacitance advanced IGBT.
- * Low thermal impedance due to direct liquid cooling.
- * High reliability, high durability module.
- * Temperature sensor with NTC thermistor.

2. ABSOLUTE MAXIMUM RATINGS (T_c=25°C)

Item	Symbol	Unit	Specification
Collector Emitter Voltage	V _{CES}	V	750 (4)
Gate Emitter Voltage	V _{GES}	V	±20
Collector Current	DC	I _C	500
	1ms	I _{Cp}	1000
Forward Current	DC	I _F	500
	1ms	I _{FM}	1000
Maximum Junction Temperature	T _{Jmax}	°C	175
Temperature under switching conditions	T _{jop}	°C	-40 ~ +175
Storage Temperature	T _{stg}	°C	-40 ~ +125
Isolation Voltage	V _{ISO}	V _{RMS}	2,500 (AC 1 minute)
Screw Torque	Terminals (M6)	-	6.0 (1)
	Mounting (M5)	-	4.0 (2)
	PCB Mounting (M3)	-	0.8 (3)

Notes: Recommended Value (1)5.5±0.5N·m, (2)3.5±0.5N·m, (3)0.65±0.15N·m.

(4)Please refer to figure of V_{CES} vs. T_c on the section 6. Static characteristics.

3. ELECTRICAL CHARACTERISTICS

Item	Symbol	Unit	Min.	Typ.	Max.	Test Conditions	
Collector Emitter Cut-Off Current	I _{CES}	mA	-	-	1.0	V _{ce} =750V, V _{ge} =0V, T _j =25°C	
Gate Emitter Leakage Current	I _{GES}	nA	-	-	±500	V _{ge} =±20V, V _{ce} =0V, T _j =25°C	
Collector Emitter Saturation Voltage	V _{CESat}	V	-	1.46	1.88	I _c =500A, V _{ge} =15V, T _j =25°C	
			-	1.65	-	I _c =500A, V _{ge} =15V, T _j =150°C	
			-	1.67	-	I _c =500A, V _{ge} =15V, T _j =175°C	
Gate Emitter Threshold Voltage	V _{GE(th)}	V	6.0	6.5	7.0	V _{ce} =5V, I _c =500mA, T _j =25°C	
Input Capacitance	C _{ies}	nF	-	7.7	-	V _{ce} =10V, V _{ge} =0V, f=100kHz, T _j =25°C	
Switching Times	Rise Time	t _r	-	0.09	0.23	V _{cc} =400V, I _c =500A, L _s =30nH, R _{g(ext)} (on/off)=15Ω/15Ω, C _{ge} =0nF, V _{ge} =+15V/-15V, T _j =150°C Inductive load	
	Turn On Time	t _{on}	-	0.26	0.48		
	Fall Time	t _f	-	0.12	0.46		
	Turn Off Time	t _{off}	-	0.44	0.74		
Peak Forward Voltage Drop	V _F	V	-	1.57	1.98	I _f =500A, V _{GE} =0V, T _j =25°C	
			-	1.55	-	I _f =500A, V _{GE} =0V, T _j =150°C	
			-	1.51	-	I _f =500A, V _{GE} =0V, T _j =175°C	
Reverse Recovery Time	t _{rr}	μs	-	0.35	0.74	V _{cc} =400V, I _c =500A, L _s =30nH,	
Turn On Loss	E _{on}	mJ/P	-	16	42	R _{g(ext)} (on/off)=15Ω/15Ω, C _{ge} =0nF	
Turn Off Loss	E _{off}	mJ/P	-	34	49	V _{ge} =+15V/-15V, T _j =150°C	
Reverse Recovery Loss	E _{rr}	mJ/P	-	25	48	Inductive load	
Thermistor Resistance	R	kΩ	-	5	-	T _c =25°C	
			-	0.16	-	T _c =150°C	
Leakage Current between Thermistor and Other Terminals		mA	-	-	0.1	V=750Vp	
SC data	I _{sc}	A	-	2400	-	V _{cc} =400V, V _{ge} ≤15V, T _j =150°C, R _{g(ext)} (on/off)≥15Ω/15Ω, t _{sc} ≤6μs	
Thermal Resistance	IGBT	R _{th(j-w)}	K/W	-	-	0.216	Junction to water/fin, 10l/min, 50%LLC (per 1 arm)
	FWD	R _{th(j-w)}	K/W	-	-	0.275	

* Please contact our representatives at order.

* For improvement, specifications are subject to change without notice.

* For actual application, please confirm this spec sheet is the newest revision.

* ELECTRICAL CHARACTERISTIC items shown in above table are according to IEC 60747-2 and IEC 60747-9.

* Switching loss depends on L_s, gate driver, C_{ge}, V_{ge}, etc.

Please optimize those values so that switching surge voltage does not exceed the rating voltage.

MBB500TX7B

Preliminary Specification

4. PACKAGE OUTLINE DRAWING

Unit in mm

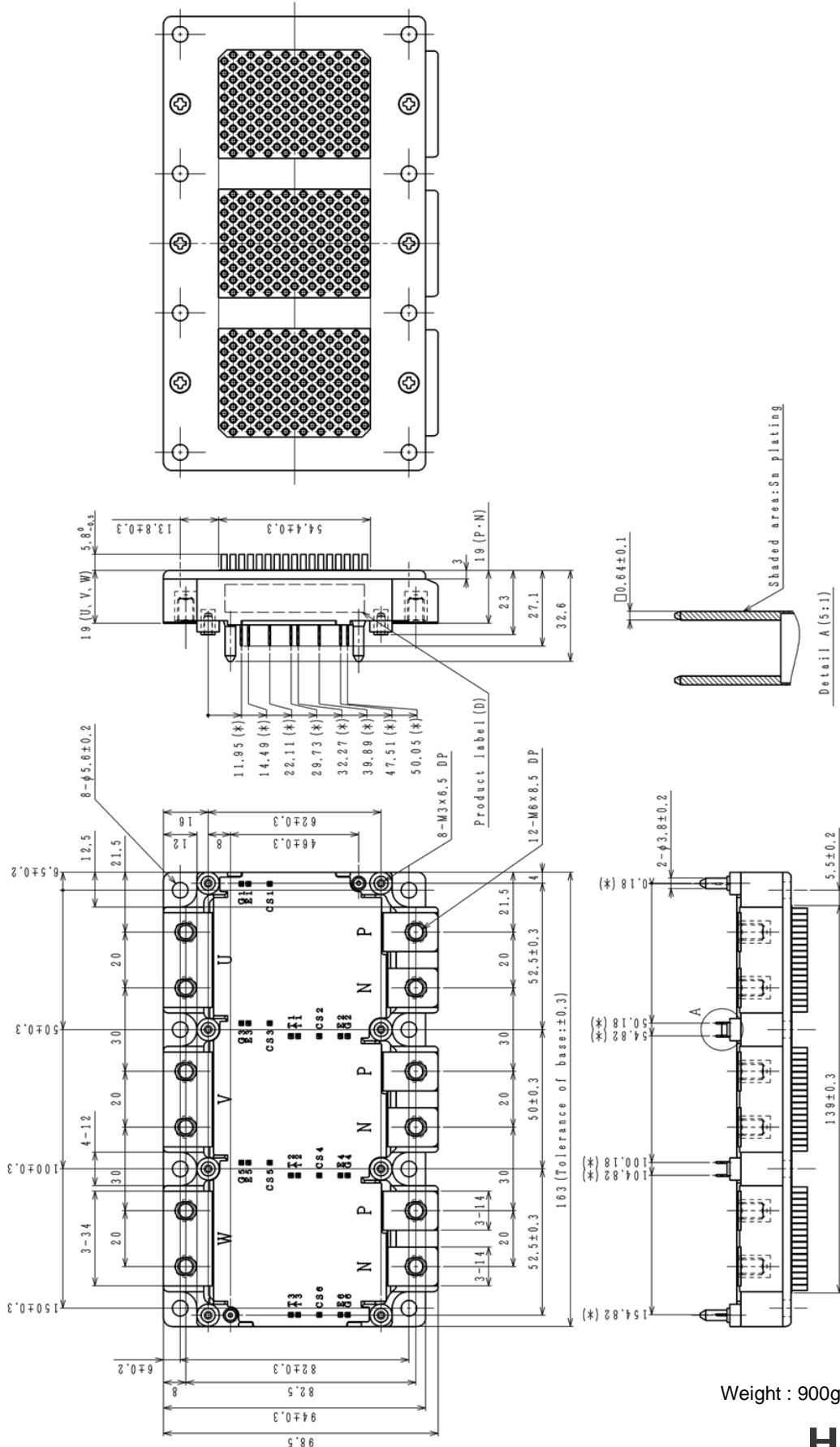

Table. Classification of basic dimension

Classification of basic dimension (x) (unit:mm)	
0.5 ≤ (x) ≤ 3	±0.2
3 < (x) ≤ 6	±0.3
6 < (x) ≤ 30	±0.5
30 < (x) ≤ 120	±0.8
120 < (x) ≤ 1000	±1.2
Tolerance	±0.2 ±0.3 ±0.5 ±0.8 ±1.2

(Note 1) Dimension of (*) is that of the root portion of terminal. (Tolerance:±0.5)
 (Note 2) Dimensional tolerance follows the right table, if not described.

Weight : 900g

MBB500TX7B

Preliminary Specification

5. CIRCUIT DIAGRAM

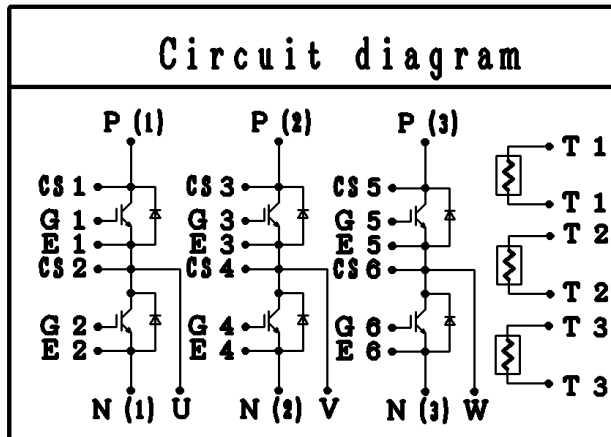

Thermistor T1, T2 and T3 are located on the same ceramic substrate with the IGBT and diode chips of phase U, V and W, respectively.

Note: This temperature measurement is not suitable for the short circuit or short term overload detection and should be used only for the module protection against long term overload or malfunction of the cooling system.

MBB500TX7B

Preliminary Specification

6. STATIC CHARACTERISTICS

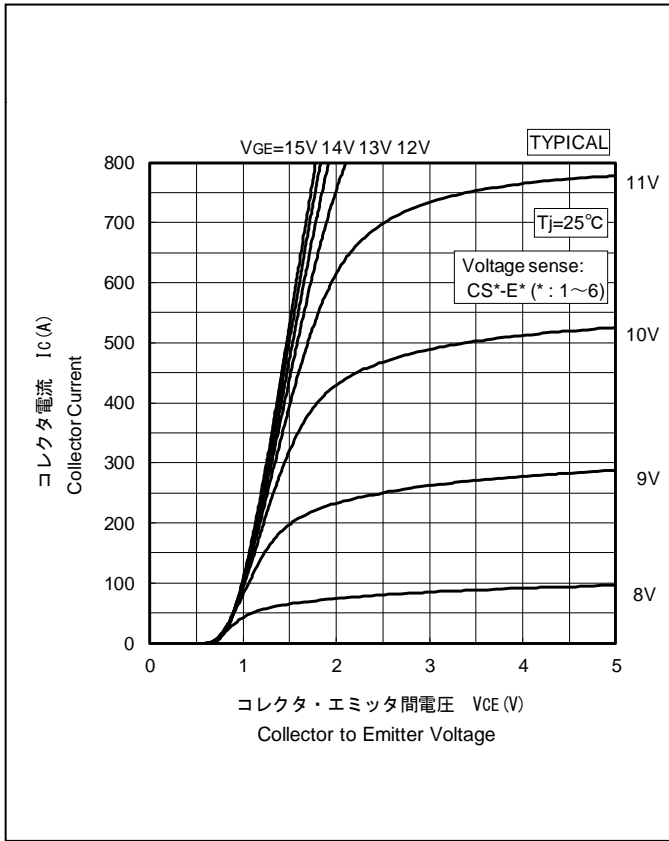

Collector Current vs. Collector to Emitter Voltage

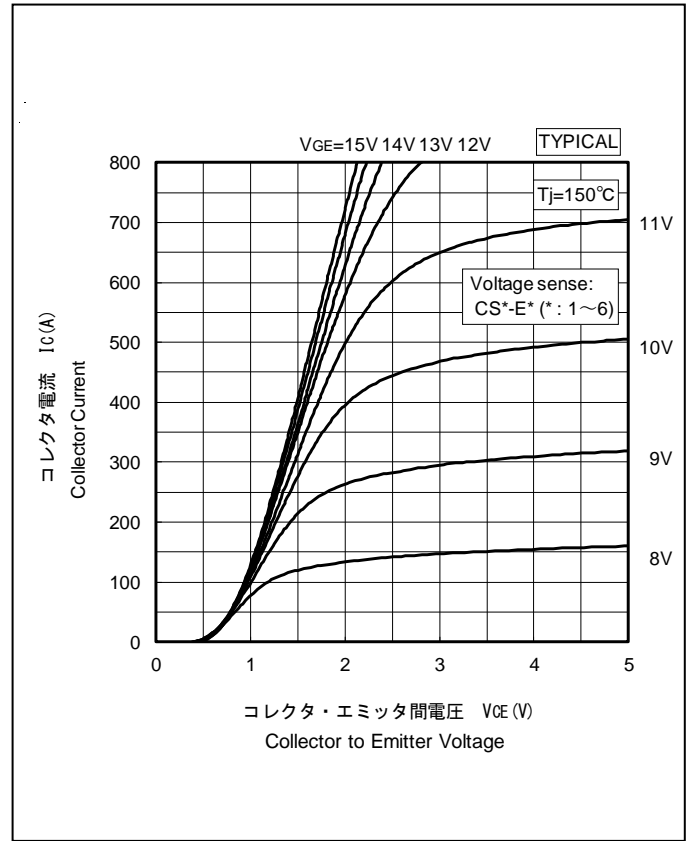

Collector Current vs. Collector to Emitter Voltage

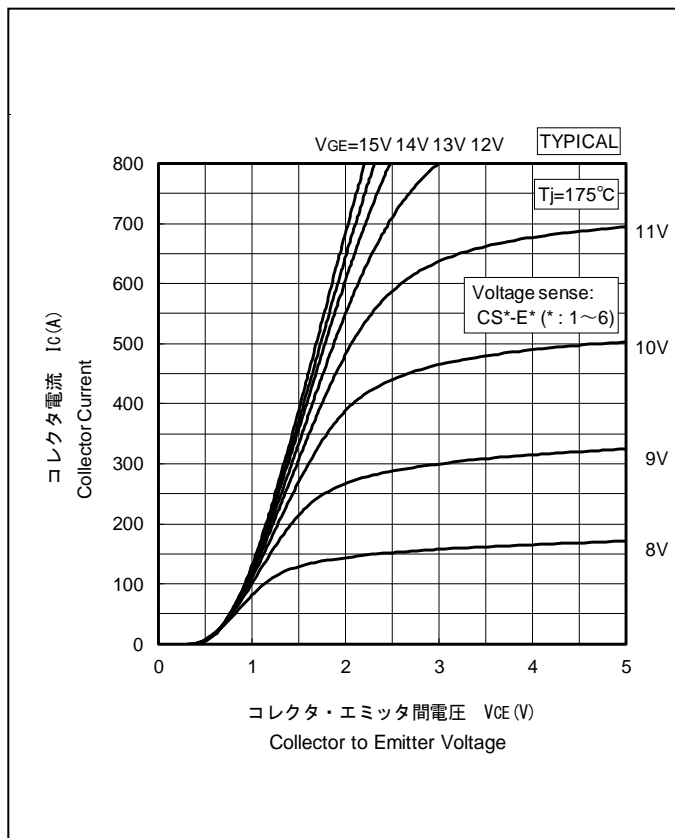

Collector Current vs. Collector to Emitter Voltage

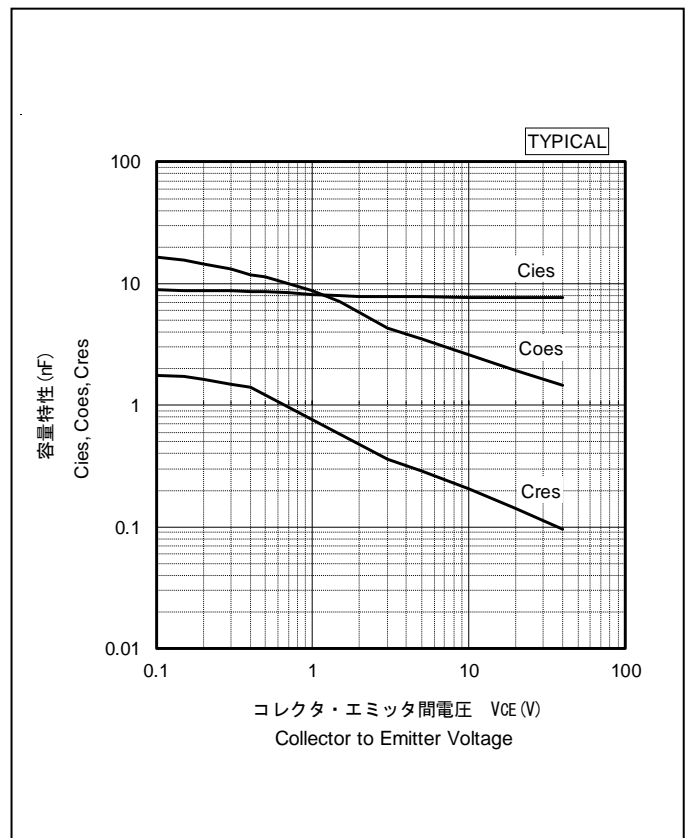

Capacitance Characteristics

MBB500TX7B

Preliminary Specification

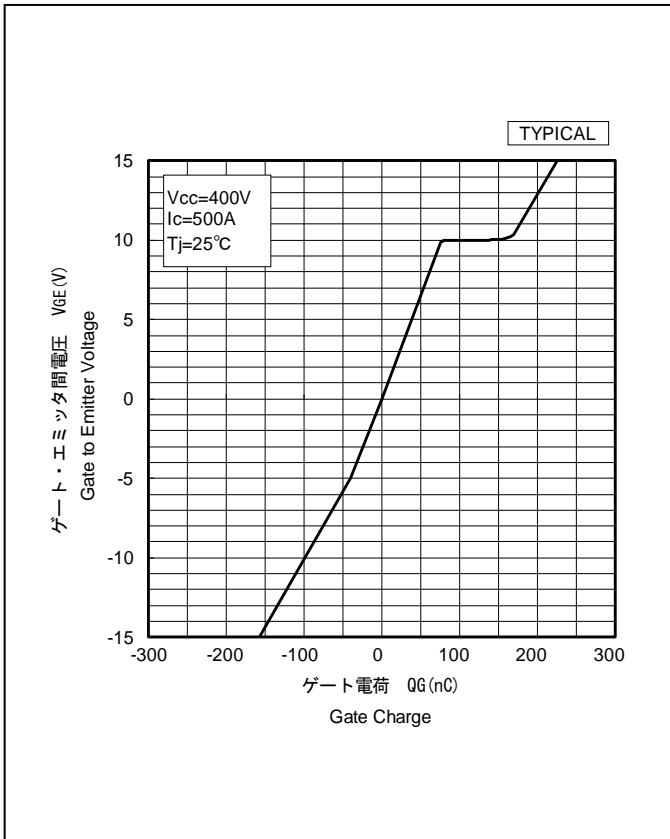

Gate Charge Characteristics

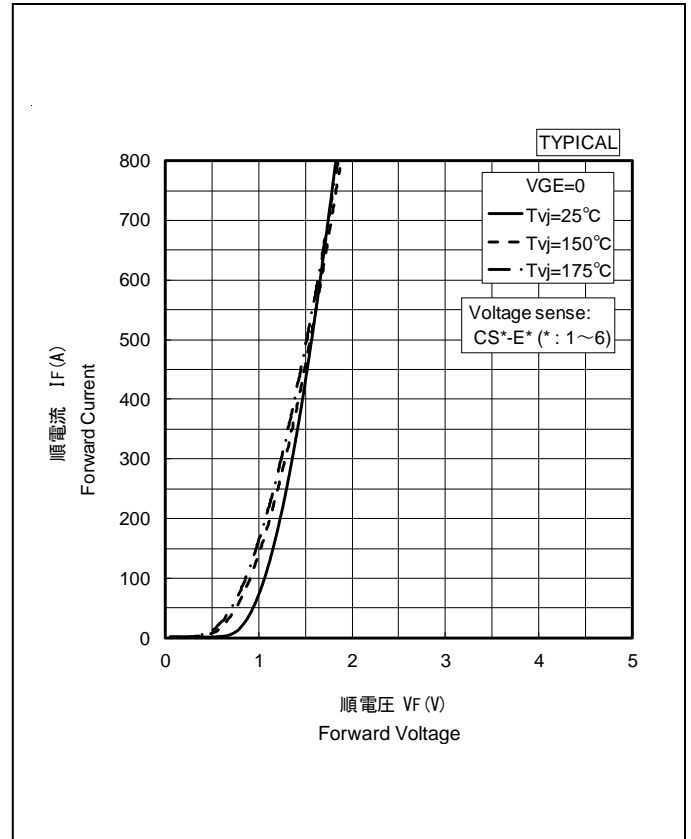

Forward Voltage of Free-Wheeling Diode

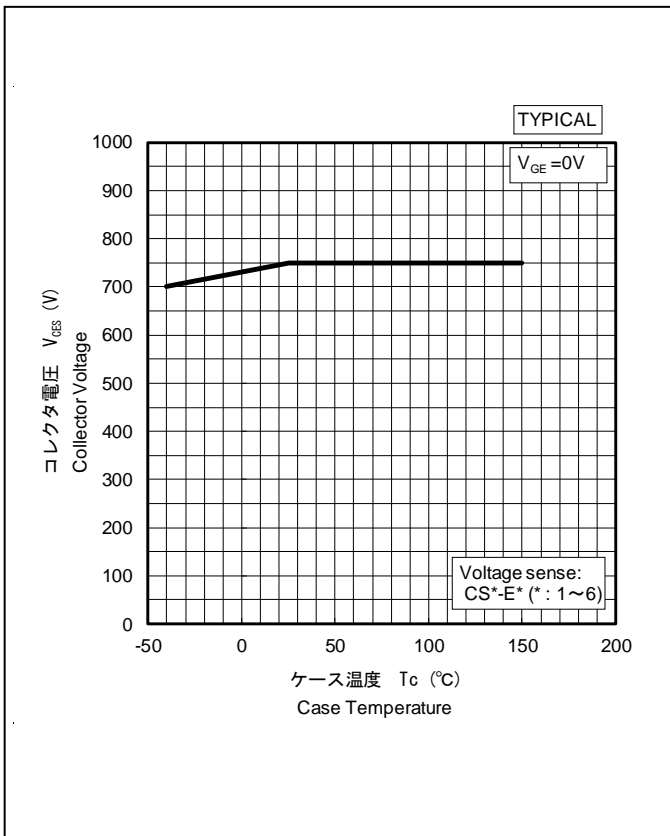

Collector Emitter Voltage vs. Case Temperature

MBB500TX7B

Preliminary Specification

7. DYNAMIC CHARACTERISTICS

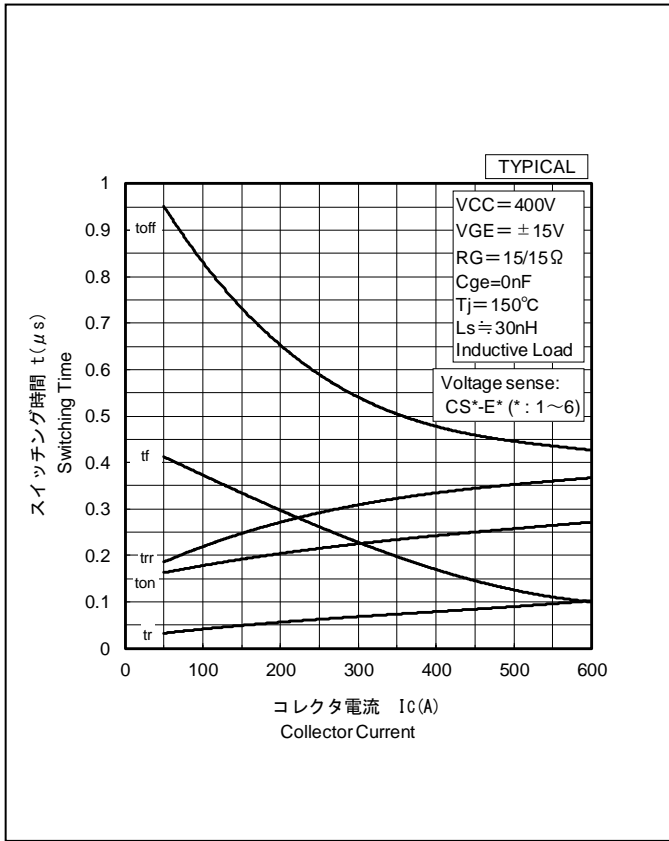

Switching Time vs. Collector Current

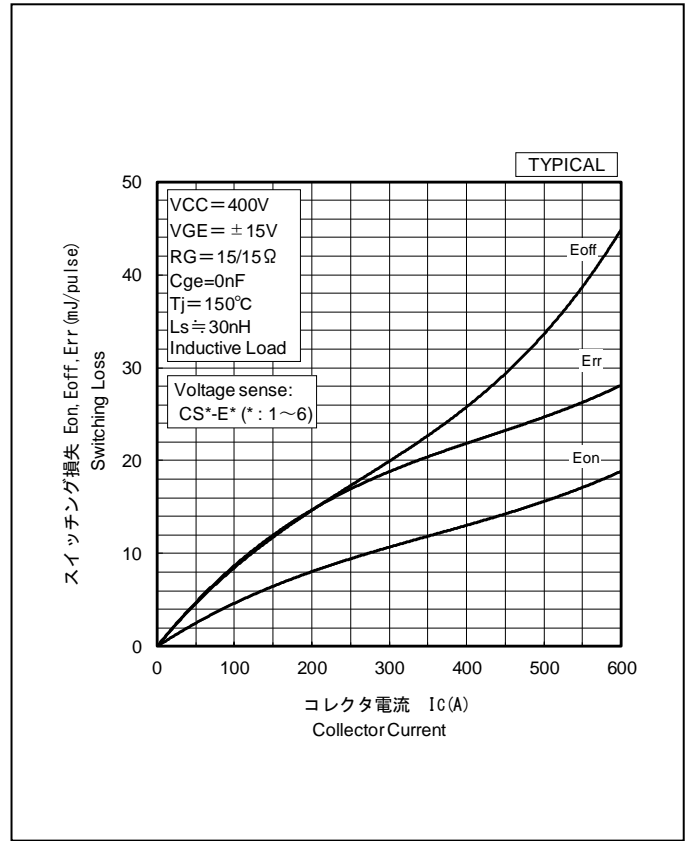

Switching Loss vs. Collector Current

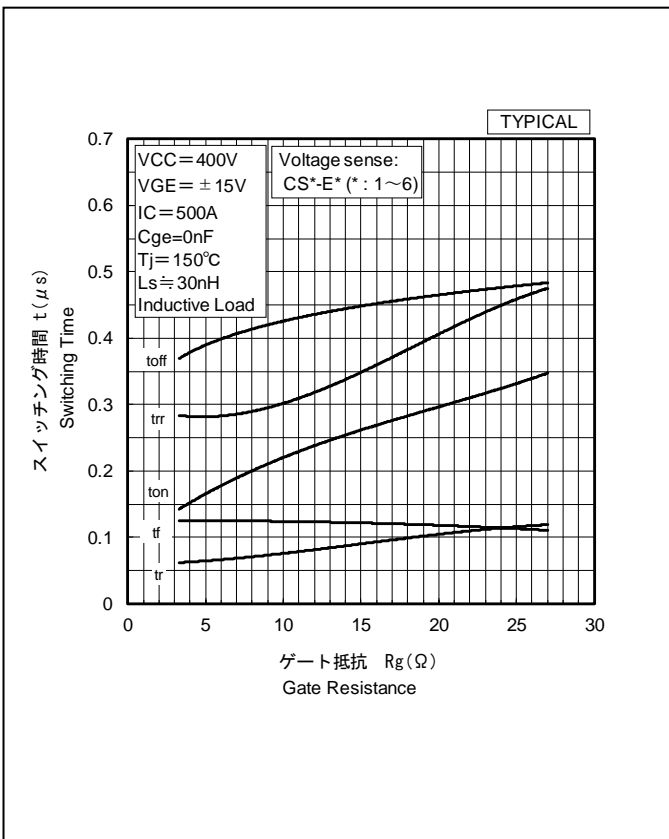

Switching Time vs. Gate Resistance

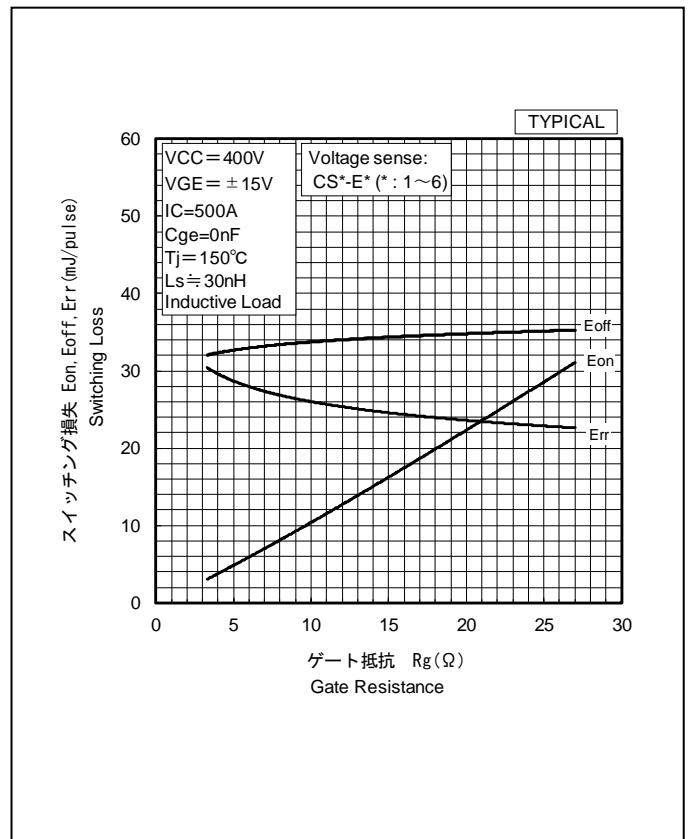

Switching Loss vs. Gate Resistance

MBB500TX7B

Preliminary Specification

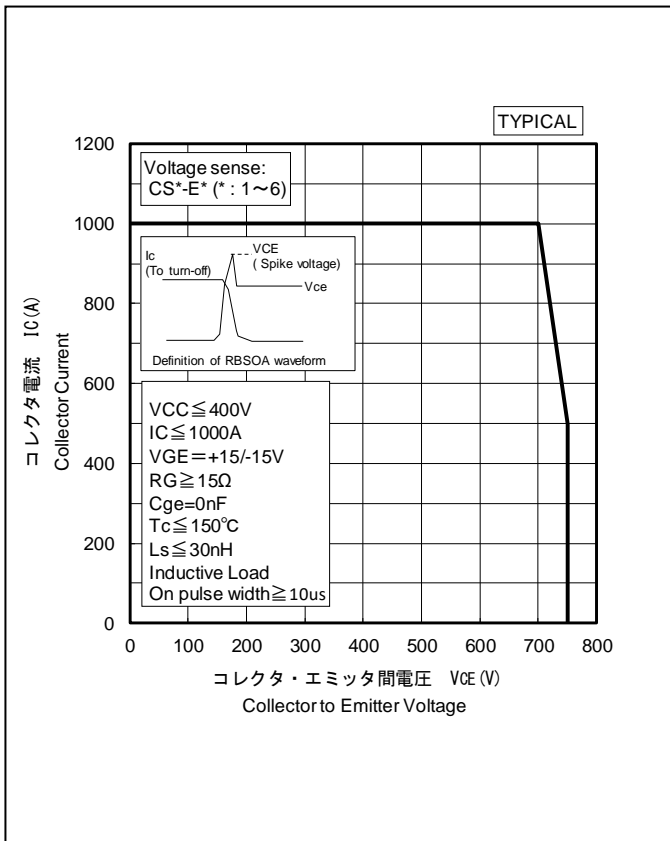

Reverse Biased Safety Operating Area

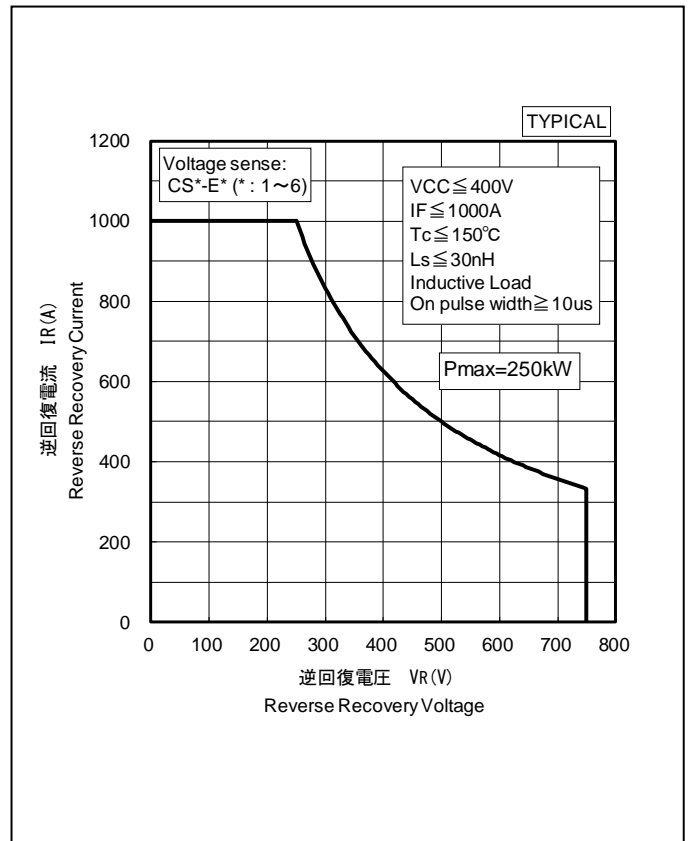

Reverse Recovery Safety Operating Area

MBB500TX7B

Preliminary Specification

8. THERMAL CHARACTERISTICS

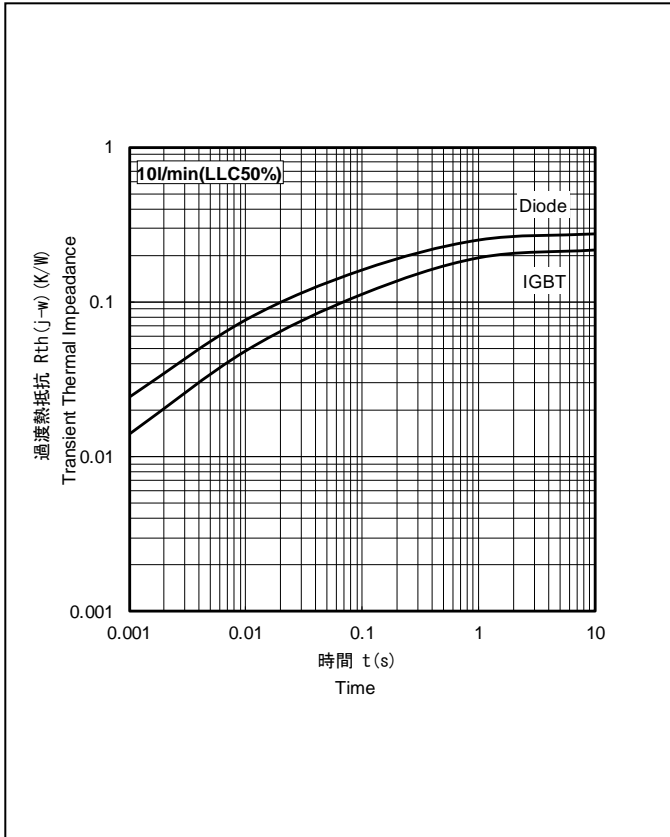

Transient Thermal Impedance Characteristics

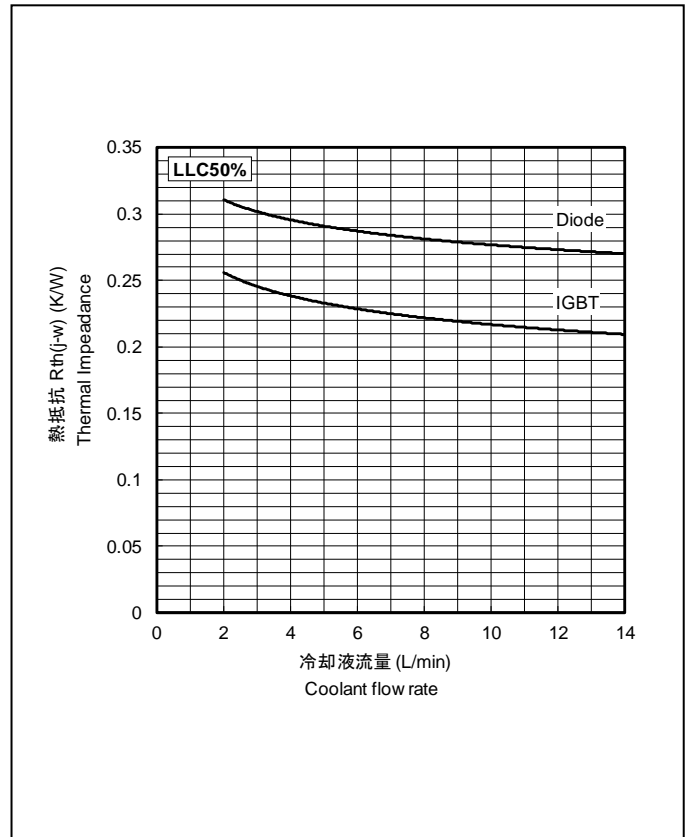

Transient Thermal Impedance vs. Coolant flow rate

Table1 Specifications of Thermistor(For reference)

Nominal zero-power resistance	5k Ω \pm 3% (25°C)
B value	3375K \pm 2% (25~50°C)
Operating temperature range	-50~150°C
Thermal time constant(in still air)	Approx. 10 sec.

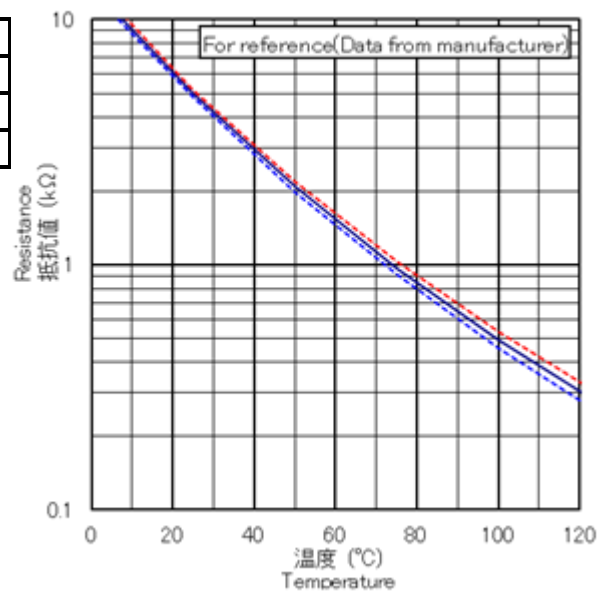

Resistance vs. Temperature

MBB500TX7B

Preliminary Specification

9. PRECAUTIONS

9-1. Storage and Shipping Precautions

Important Notices

(1) IGBT modules should always be stored under the following conditions.

- Temperature : 40 degrees Celsius, maximum.
- Humidity : 60% Relative Humidity, maximum.
- Dust : Avoid storing the module in locations subject to dust.
- Harmful substances : The installation location should be free of corrosive gases such as sulfur dioxide and chlorine gas.
- Other : Do not remove the conductive sponges or tapes attached to the signal gate and emitter gate.

(2) Shipping Method

- To prevent the case cracking and/or the electrode bending, appropriate consideration should be given to properly insulate the shipping container from mechanical shock or sever vibration situation.
- Do not throw or drop the case while shipping. Treat them with care. The devices may break if they are not handled with care. Please do not use the IGBT modules that were dropped or damaged.
- Appropriate labeling on the outside of the shipping container should always be present.
- The shipping container itself should always be properly protected from both rain and water.

9-2. Precautions against Electrostatic Failure

Important Notices

Because the IGBT has a MOS gate structure and temperature sensing diode, you should always take the following precautions as measures to avoid generating static electricity.

- Before starting operation, do not remove the conductive sponge mounted between terminals of gate, emitter, collector, temperature sensing anode and cathode.
- When handling the IGBT module, ground our body via a high-value resistor (between 100kΩ and 1MΩ), hold the package body, and do not touch the terminals of gate, temperature sensing anode and cathode.
- Be sure to ground any parts which the IGBT module may touch, such as the work table or soldering iron.
- Before testing or inspection, be sure to check that any residual electric charge in measuring instruments has been removed. Apply voltage to each terminal starting at 0V and return to 0V when finishing.

MBB500TX7B

Preliminary Specification

HITACHI POWER SEMICONDUCTORS

Notices

1. Since mishandling of semiconductor devices may cause malfunctions, please be sure to read "Precautions for Safe Use and Notices" in the individual brochure before use.
2. When designing an electronic circuit using semiconductor devices, please do not exceed the absolute maximum rating specified for the device under any external fluctuations. And for pulse applications, please also do not exceed the "Safe Operating Area (SOA)".
3. Semiconductor devices may sometimes break down by accidental or unexpected surge voltage, so please be careful about the safety design such as redundant design and malfunction prevention design which don't cause the damage expand even if they break down.
4. In cases where extremely high reliability is required (such as use in nuclear power control, aerospace and aviation, traffic equipment, life-support-related medical equipment, fuel control equipment and various kinds of safety equipment), safety should be ensured by using semiconductor devices that feature assured safety or by means of users' fail-safe precautions or other arrangement. Or consult with Hitachi's sales department staff. (When semiconductor devices fail, as a result the semiconductor devices or wiring, wiring pattern may smoke, ignite, or the semiconductor devices themselves may burst.)
5. A semi-processed article is done now using solder which contains lead inside the semiconductor devices. There is possibility of the regulation substance depend on the applied models, so please check before using.
6. This specification is a material for component selection, which describes specifications of power semiconductor devices (hereinafter referred to as products), characteristic charts, and external dimension drawings.
7. The information given herein, including the specifications and dimensions, is subject to change without prior notice to improve product characteristics. Before ordering, purchasers are advised to contact with Hitachi power semiconductor sales department for the latest version of this data sheets.
8. For handling other than described in this manual, follow the handling instructions (IGBT-HI-00002).

■ For inquiries relating to the products, please contact nearest representatives which is located "Inquiry" portion on the top page of a home page.

Hitachi power semiconductor home page address

<http://www.hitachi-power-semiconductor-device.co.jp/>

<http://www.hitachi-power-semiconductor-device.co.jp/en/>

HITACHI
Inspire the Next

MBB500TX7B

Preliminary Specification

HITACHI POWER SEMICONDUCTORS

Usage

1. HPSD warrants that the HPSD products have the specified performance according to the respective specifications at the time of its sale. Testing and other quality control techniques of the HPSD products by HPSD are utilized to the extent HPSD needs to meet the specifications described in this document. Not every device of the HPSD products is specifically tested on all parameters, except those mandated by relevant laws and/or regulations.
2. Following any claim regarding the failure of a product to meet the performance described in this document made within one month of product delivery, all the products in relevant lot(s) shall be re-tested and re-delivered. The HPSD products delivered more than one month before such a claim shall not be counted for such response.
3. HPSD assumes no obligation nor makes any promise of compensation for any fault which should be found in a customer's goods incorporating the products in the market. If a product failure occurs for reasons obviously attributable to HPSD and a claim is made within six months of product delivery, HPSD shall offer free replacement or payment of compensation. The maximum compensation shall be the amount paid for the products, and HPSD shall not assume responsibility for any other compensation.
4. HPSD reserves the right to make changes in this document and to discontinue mass production of the relevant products without notice. Customers are advised to confirm specification of the product of inquiry before purchasing of the products that the customer desired. Customers are further advised to confirm before purchasing of such above products that the product of inquiry is the latest version and that the relevant product is in mass production status if the purchasing of the products by the customer is suspended for one year or more.
5. When you dispose of HPSD products and/or packing materials, comply with the laws and regulations of each country and/or local government. Conduct careful preliminary studies about environmental laws applying to your products such as RoHS, REACH. HPSD shall not assume responsibility for compensation due to contravention of laws and/or regulations.
6. HPSD shall not be held liable in any way for damages and infringement of patent rights, copyright or other intellectual property rights arising from or related to the use of the information, products, and circuits in this document.
7. No license is granted by this document of any patents, copyright or other intellectual property rights of any third party or of HPSD.
8. This document may not be reprinted, reproduced or duplicated, in any form, in whole or in part without the express written permission of HPSD.
9. You shall not use the HPSD products (technologies) described in this document and any other products (technologies) manufactured or developed by using them (hereinafter called "END Products") or supply the HPSD products (technologies) and END Products for the purpose of disturbing international peace and safety, including (i) the design, development, production, stockpiling or any use of weapons of mass destruction such as nuclear, chemical or biological weapons or missiles, (ii) the other military activities, or (iii) any use supporting these activities. You shall not sell, export, dispose of, license, rent, transfer, disclose or otherwise provide the HPSD products (technologies) and END Products to any third party whether directly or indirectly with knowledge or reason to know that the third party or any other party will engage in the activities described above.

When exporting, re-export transshipping or otherwise transferring the HPSD products (technologies) and END Products, all necessary procedures are to be taken in accordance with Foreign Exchange and Foreign Trade Act (Foreign Exchange Act) of Japan, Export Administration Regulations (EAR) of US, and any other applicable export control laws and regulations promulgated and administered by the governments of the countries asserting jurisdictions over the parties or transaction.