

Key Parameters

V_{DSM}	=	2800 V
I_{TAVM}	=	2350 A
I_{TRMS}	=	3680 A
I_{TSM}	=	43000 A
V_{TO}	=	0.85 V
r_T	=	0.160 mΩ

Phase Control Thyristor

5STP 24L2800

Doc. No. 5SYA 1029-02 Dec.95

Features

- Patented free-floating silicon technology
- Designed for traction, energy and industrial applications
- Optimum power handling capability

Blocking

Part number	5STP 24L2800	5STP 24L2600	5STP 24L2200	Conditions
V_{DRM} V_{RRM}	2800 V	2600 V	2200 V	$f = 50\text{Hz}$, $t_p = 10\text{ms}$
V_{RSM1}	3000 V	2800 V	2400 V	$t_p = 5\text{ms}$, single pulse
I_{DRM}	$\leq 300\text{ mA}$			V_{DRM}
I_{RRM}	$\leq 300\text{ mA}$			V_{RRM}
dv/dt_{crit}	1000 V/ μs			@ Exp.to 0.67x V_{DR}
$T_{vj} = 125^\circ\text{C}$				

Mechanical data

F_m	Mounting force	nom	50 kN
		min	45 kN
		max	60 kN
a	Acceleration Device clamped		100 m/s ²
m	Weight		1.35 kg
D_s	Surface creepage distance		35 mm
D_a	Air strike distance		14 mm

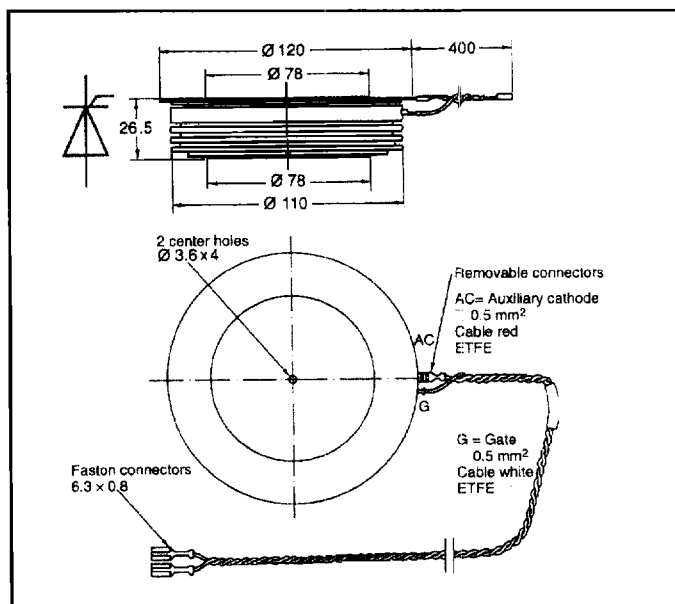

On-state

I_{TAVM}	Max. average on-state current	2350 A	Half sine wave, $T_c = 70^\circ\text{C}$	
I_{TRMS}	Max. RMS on-state current	3680 A		
I_{TSM}	Max. peak non-repetitive surge current	43000 A	$t_p = 10\text{ ms}$	$T_{vj} = 125^\circ\text{C}$
		46000 A	$t_p = 8.3\text{ ms}$	
I^2t	Limiting load integral	9245 kA ² s	$t_p = 10\text{ ms}$	
		8781 kA ² s	$t_p = 8.3\text{ ms}$	
V_T	On-state voltage	1.35 V	$I_T = 3000\text{ A}$	
V_{TO}	Threshold voltage	0.85 V		
r_T	Slope resistance	0.160 mΩ	$I_T = 1500 - 4500\text{ A}$	
I_H	Holding current	20-70 mA	$T_{vj} = 25^\circ\text{C}$	
		15-60 mA	$T_{vj} = 125^\circ\text{C}$	
I_L	Latching current	80-300 mA	$T_{vj} = 25^\circ\text{C}$	
		70-250 mA	$T_{vj} = 125^\circ\text{C}$	

Switching

di/dt_{crit}	Critical rate of rise of on-state current	150 A/μs	Cont.	$V_D \leq 0.67 \times V_{DRM}$ $T_{vj} = 125^\circ\text{C}$ $I_{TRM} = 3000\text{ A}$ $f = 50\text{ Hz}$ $I_{FG} = 2.0\text{ A}$ $t_r = 0.5\text{ μs}$
		300 A/μs	60 sec.	
t_d	Delay time	$\leq 3.0\text{ μs}$	$V_D = 0.4 \times V_{DRM}$	$I_{FG} = 2.0\text{ A}$ $t_r = 0.5\text{ μs}$
t_q	Turn-off time	$\leq 400\text{ μs}$	$V_D \leq 0.67 \times V_{DRM}$ $dv_D/dt = 20\text{ V/μs}$	$I_{TRM} = 3000\text{ A}$ $T_{vj} = 125^\circ\text{C}$ $V_R > 200\text{ V}$
Q	Recovery charge	min	4000 μAs	$di_T/dt = -20\text{ A/μs}$
		max	7000 μAs	

Triggering

V_{GT}	Gate trigger voltage	2.6 V	$T_{vj} = 25^\circ\text{C}$
I_{GT}	Gate trigger current	400 mA	$T_{vj} = 25^\circ\text{C}$
V_{GD}	Gate non-trigger voltage	0.3 V	$V_D = 0.4 \times V_{DRM}$
I_{GD}	Gate non-trigger DC current	10 mA	$V_D = 0.4 \times V_{DRM}$
V_{FGM}	Peak forward gate voltage	12 V	
I_{FGM}	Peak forward gate current	10 A	
V_{RGM}	Peak reverse gate voltage	10 V	
P_G	Gate power losses	3 W	

Thermal

$T_{vj\ max}$	Max. junction temperature	125 °C	
$T_{vj\ stg}$	Storage temperature range	-40...150°C	
R_{thJC}	Thermal resistance junction to case	24 K/kW	Anode side cooled
		24 K/kW	Cathode side cooled
		12 K/kW	Double side cooled
R_{thCH}	Thermal resistance case to heat sink	10 K/kW	Single side cooled
		5 K/kW	Double side cooled

Analytical function for transient thermal impedance:

$$Z_{thJC} = \sum_{i=1}^n R_i(1-e^{-t/\tau_i})$$

i	1	2	3	4
R_i (K/W)	0.0053	0.0051	0.0016	
τ_i (s)	2.1838	0.4151	0.0324	

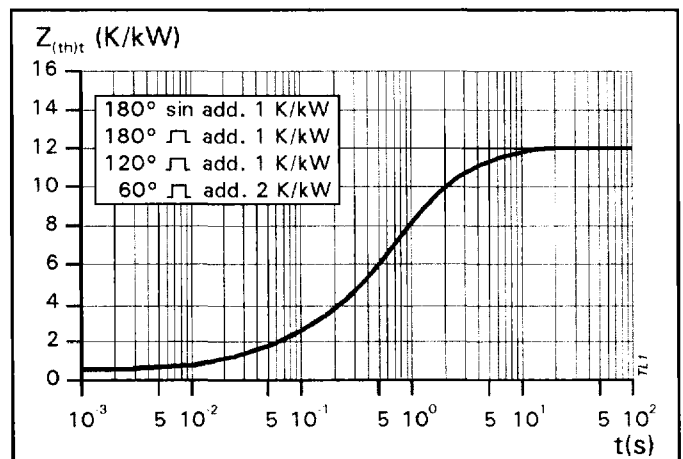

Fig.1 Transient thermal impedance, junction to case.

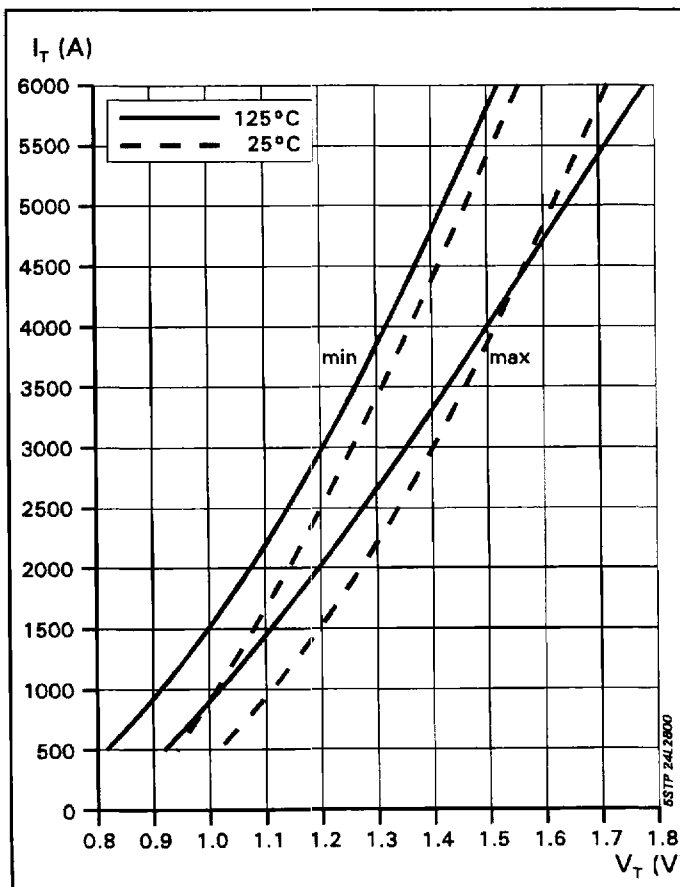

Fig.2 On-state characteristics.

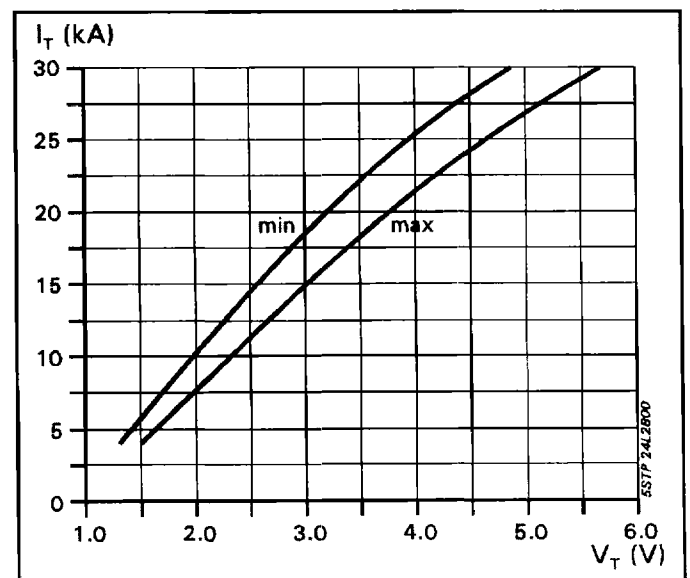

Fig.3 On-state characteristics.

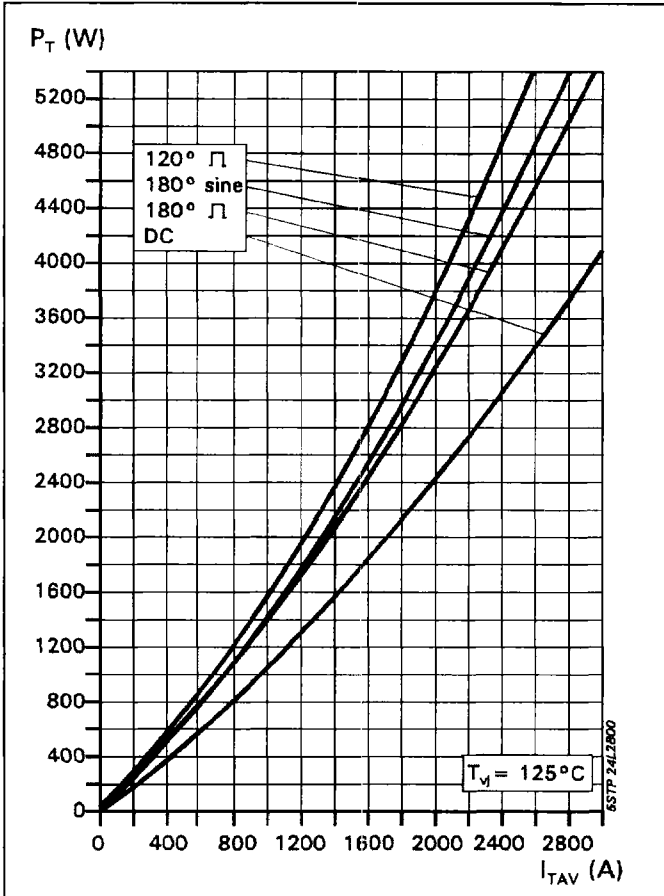

Fig.4 On-state power loss vs mean on-state current. Turn-on losses excluded.

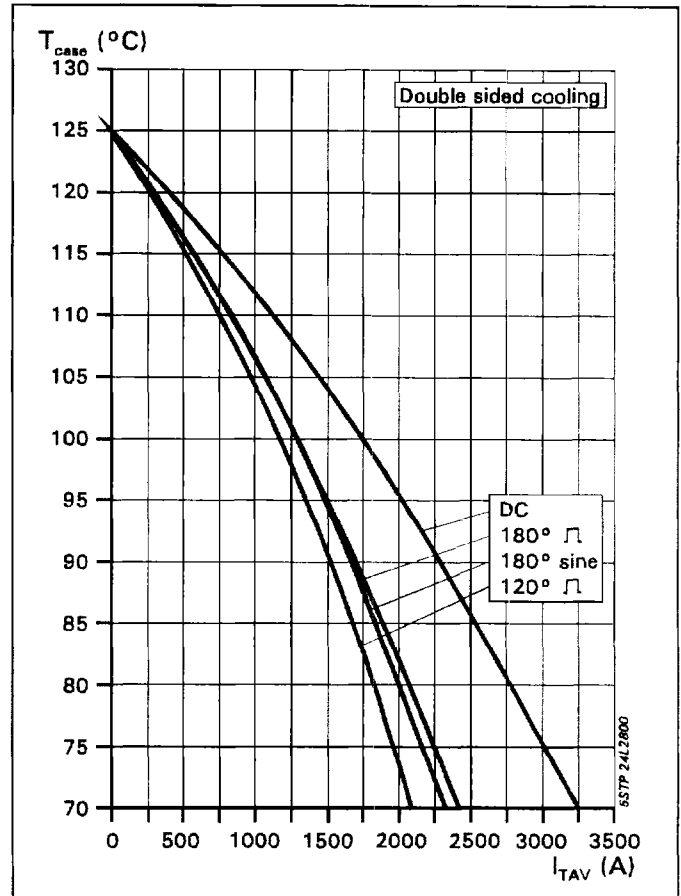

Fig.5 Max. permissible case temperature vs mean on-state current.

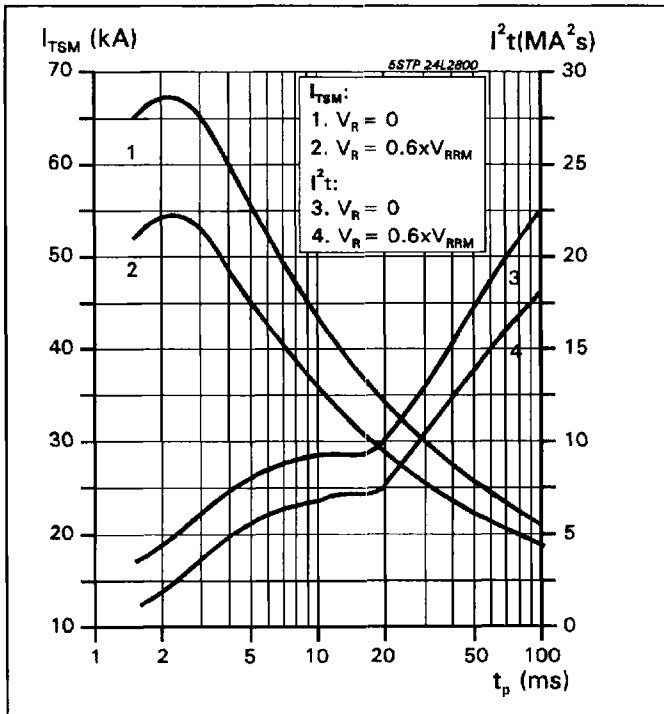

Fig.6 Surge on-state current vs pulse length. Half-sine wave.

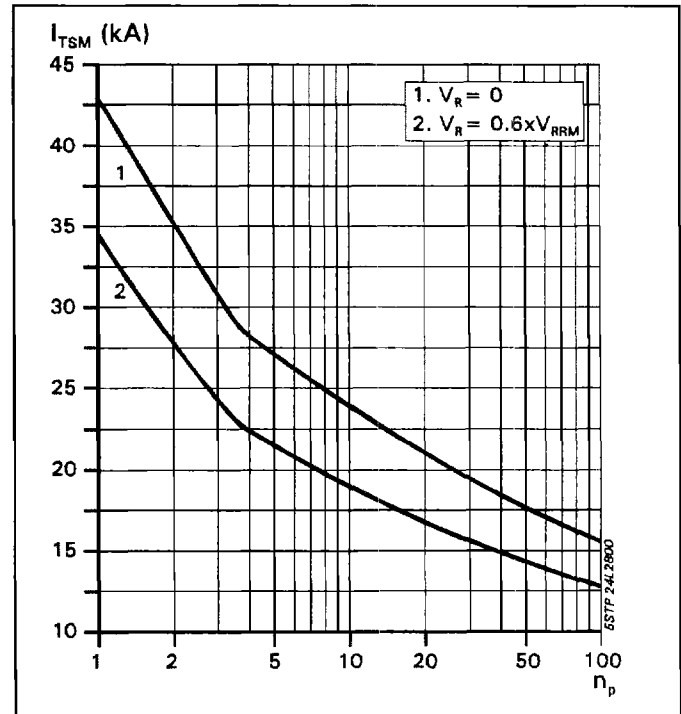

Fig.7 Surge on-state current vs number of pulses. Half-sine wave, 10ms, 50Hz.

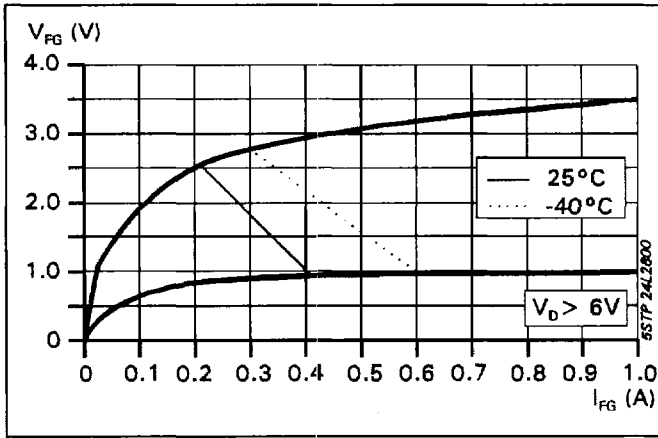

Fig.8 Gate trigger characteristics.

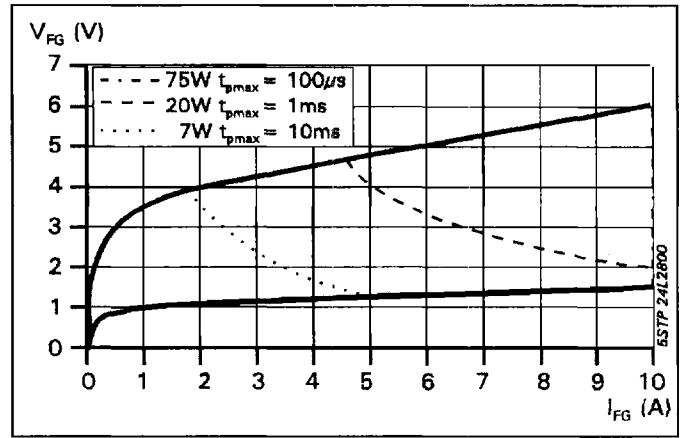

Fig.9 Max. peak gate power loss.

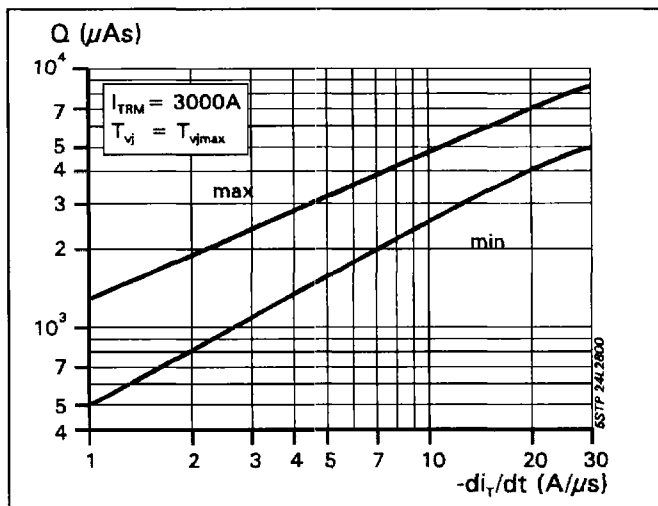

Fig.10 Recovery charge vs decay rate of on-stat current.

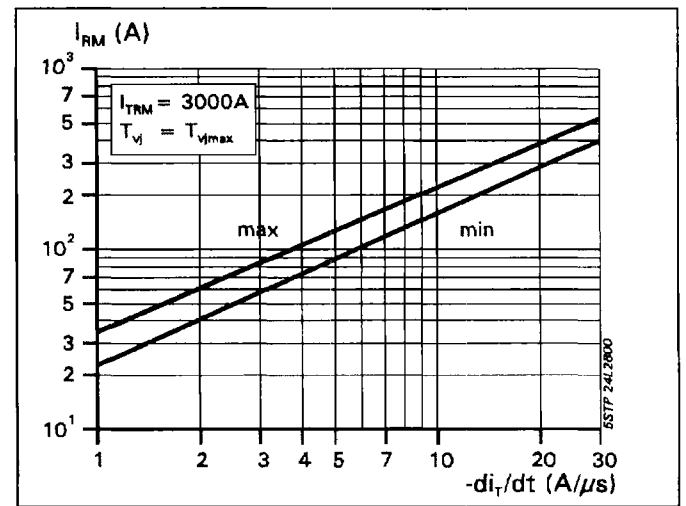

Fig.11 Peak reverse recovery current vs decay rate of on-state current.