

$V_{DSM}$	=	2800 V
$I_{TAVM}$	=	2625 A
$I_{TRMS}$	=	4120 A
$I_{TSM}$	=	43000 A
$V_{T0}$	=	0.85 V
$r_T$	=	0.160 mW

## Phase Control Thyristor

# 5STP 24H2800

Doc. No. 5SYA1047-02 Aug.00

- Patented free-floating silicon technology
- Low on-state and switching losses
- Designed for traction, energy and industrial applications
- Optimum power handling capability

### Blocking

Part Number	5STP 24H2800	5STP 24H2600	5STP 24H2200	Conditions
$V_{DRM}$ $V_{RRM}$	2800 V	2600 V	2200 V	$f = 50$ Hz, $t_p = 10$ ms
$V_{RSM1}$	3000 V	2800 V	2400 V	$t_p = 5$ ms, single pulse
$I_{DRM}$	$\leq 300$ mA			$V_{DRM}$
$I_{RRM}$	$\leq 300$ mA			$V_{RRM}$
$dV/dt_{crit}$	1000 V/ $\mu$ s			@ Exp. to $0.67 \times V_{DRM}$

$T_j = 125^\circ\text{C}$

### Mechanical data

$F_M$	Mounting force	nom.	50 kN
		min.	45 kN
		max.	60 kN
a	Acceleration		
	Device unclamped		50 m/s <sup>2</sup>
	Device clamped		100 m/s <sup>2</sup>
m	Weight		0.9 kg
$D_S$	Surface creepage distance		36 mm
$D_a$	Air strike distance		15 mm



ABB Semiconductors AG reserves the right to change specifications without notice.

## On-state

$I_{TAVM}$	Max. average on-state current	2625 A	Half sine wave, $T_C = 70^\circ\text{C}$	
$I_{TRMS}$	Max. RMS on-state current	4120 A		
$I_{TSM}$	Max. peak non-repetitive surge current	43000 A	$t_p = 10 \text{ ms}$	$T_j = 125^\circ\text{C}$ After surge: $V_D = V_R = 0\text{V}$
		46000 A	$t_p = 8.3 \text{ ms}$	
$I^2t$	Limiting load integral	9245 $\text{kA}^2\text{s}$	$t_p = 10 \text{ ms}$	
		8781 $\text{kA}^2\text{s}$	$t_p = 8.3 \text{ ms}$	
$V_T$	On-state voltage	1.35 V	$I_T = 3000 \text{ A}$	$T_j = 125^\circ\text{C}$
$V_{T0}$	Threshold voltage	0.85 V	$I_T = 1500 - 4500 \text{ A}$	
$r_T$	Slope resistance	0.160 $\text{m}\Omega$		
$I_H$	Holding current	25-75 mA	$T_j = 25^\circ\text{C}$	
		15-60 mA	$T_j = 125^\circ\text{C}$	
$I_L$	Latching current	150-600 mA	$T_j = 25^\circ\text{C}$	
		50-200 mA	$T_j = 125^\circ\text{C}$	

## Switching

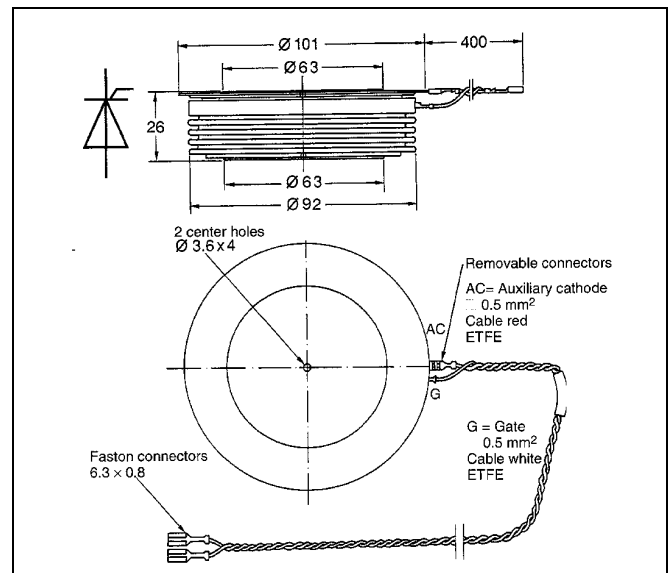
$di/dt_{crit}$	Critical rate of rise of on-state current	150 $\text{A}/\mu\text{s}$	Cont.	$V_D \leq 0.67 \cdot V_{DRM}$ $T_j = 125^\circ\text{C}$ $I_{TRM} = 3000 \text{ A}$ $f = 50 \text{ Hz}$ $I_{FG} = 2.0 \text{ A}$ $t_r = 0.5 \mu\text{s}$
		300 $\text{A}/\mu\text{s}$	60 sec.	
$t_d$	Delay time	$\leq 3.0 \mu\text{s}$	$V_D = 0.4 \cdot V_{DRM}$	$I_{FG} = 2.0 \text{ A}$ $t_r = 0.5 \mu\text{s}$
$t_q$	Turn-off time	$\leq 400 \mu\text{s}$	$V_D \leq 0.67 \cdot V_{DRM}$ $dv_D/dt = 20\text{V}/\mu\text{s}$	$I_{TRM} = 3000 \text{ A}$ $T_j = 125^\circ\text{C}$ $V_R > 200 \text{ V}$
$Q_{rr}$	Recovery charge	min	4000 $\mu\text{As}$	$di_T/dt = -20 \text{ A}/\mu\text{s}$
		max	7000 $\mu\text{As}$	

## Triggering

$V_{GT}$	Gate trigger voltage	2.6 V	$T_j = 25^\circ\text{C}$
$I_{GT}$	Gate trigger current	400 mA	$T_j = 25^\circ\text{C}$
$V_{GD}$	Gate non-trigger voltage	0.3 V	$V_D = 0.4 \cdot V_{DRM}$
$I_{GD}$	Gate non-trigger current	10 mA	$V_D = 0.4 \cdot V_{DRM}$
$V_{FGM}$	Peak forward gate voltage	12 V	
$I_{FGM}$	Peak forward gate current	10 A	
$V_{RGM}$	Peak reverse gate voltage	10 V	
$P_G$	Maximum gate power loss	3 W	

### Thermal

$T_{j\max}$	Max. junction temperature	125°C	
$T_{j\text{stg}}$	Storage temperature range	-40...150°C	
$R_{\text{thJC}}$	Thermal resistance junction to case	20 K/kW	Anode side cooled
		20 K/kW	Cathode side cooled
		10 K/kW	Double side cooled
$R_{\text{thCH}}$	Thermal resistance case to heat sink	4 K/kW	Single side cooled
		2 K/kW	Double side cooled

Analytical function for transient thermal impedance:

$$Z_{\text{thJC}}(t) = \sum_{i=1}^n R_i(1 - e^{-t/\tau_i})$$

i	1	2	3	4
$R_i$ (K/kW)	6.52	1.55	1.67	0.49
$\tau_i$ (s)	0.4562	0.0792	0.0088	0.0037

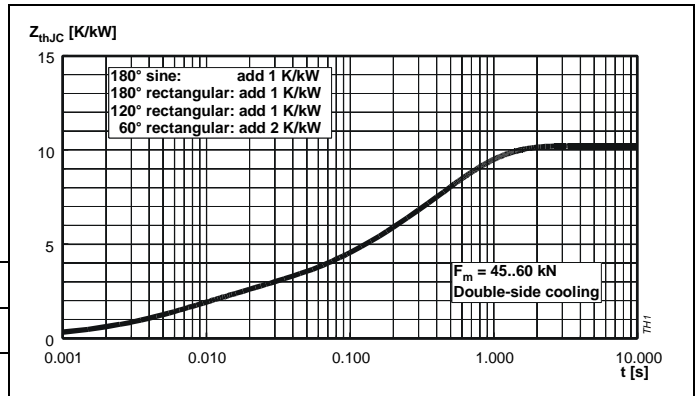

Fig. 1 Transient thermal impedance junction to case.

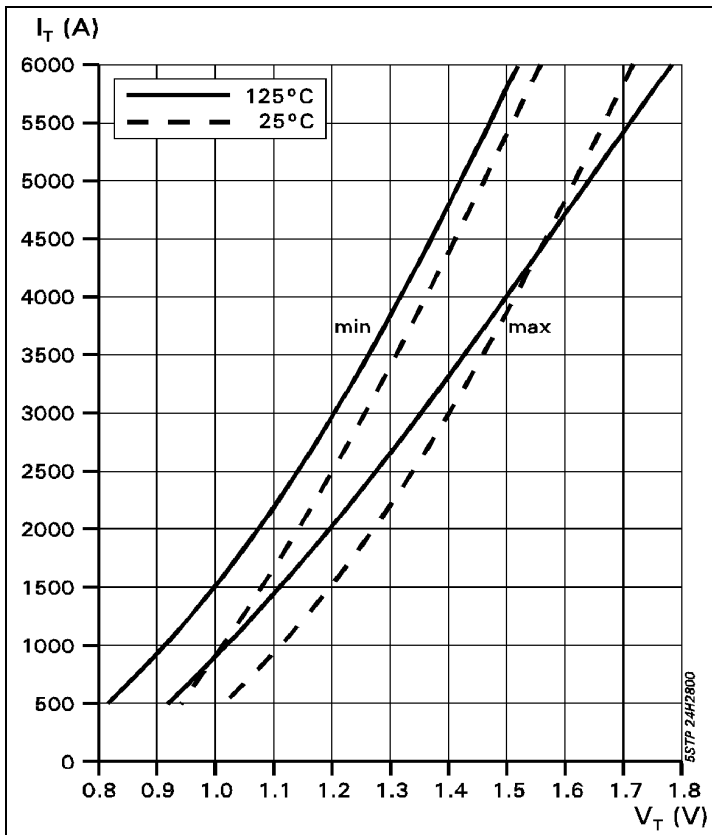

Fig. 2. On-state characteristics.

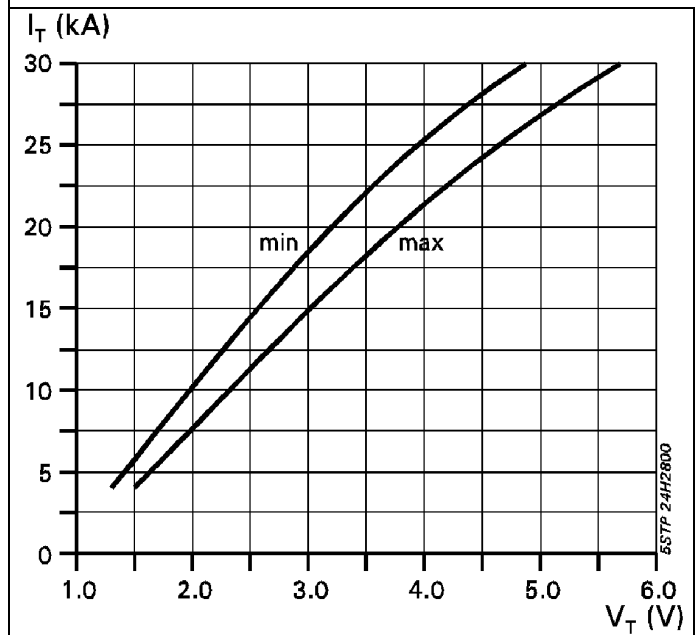
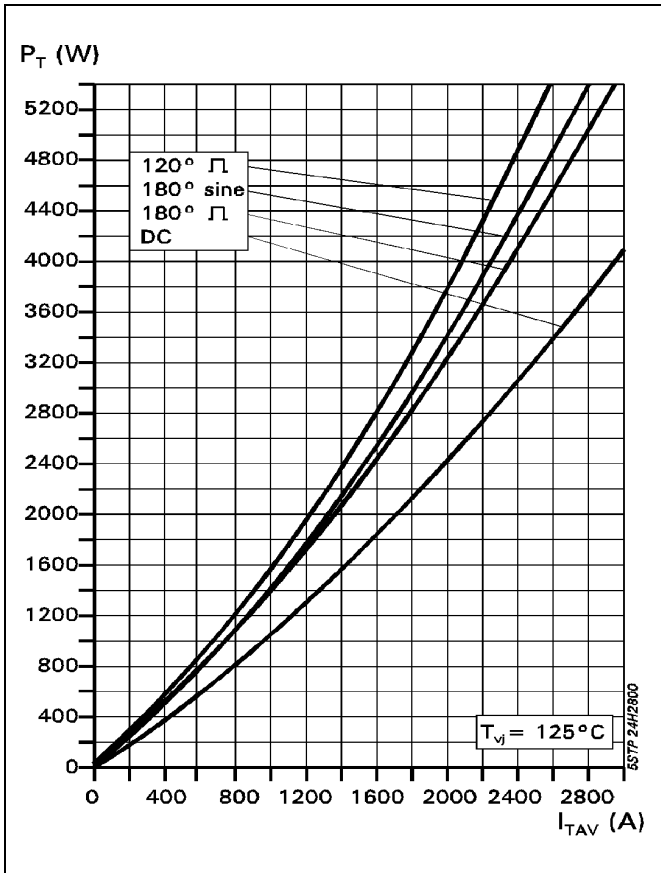
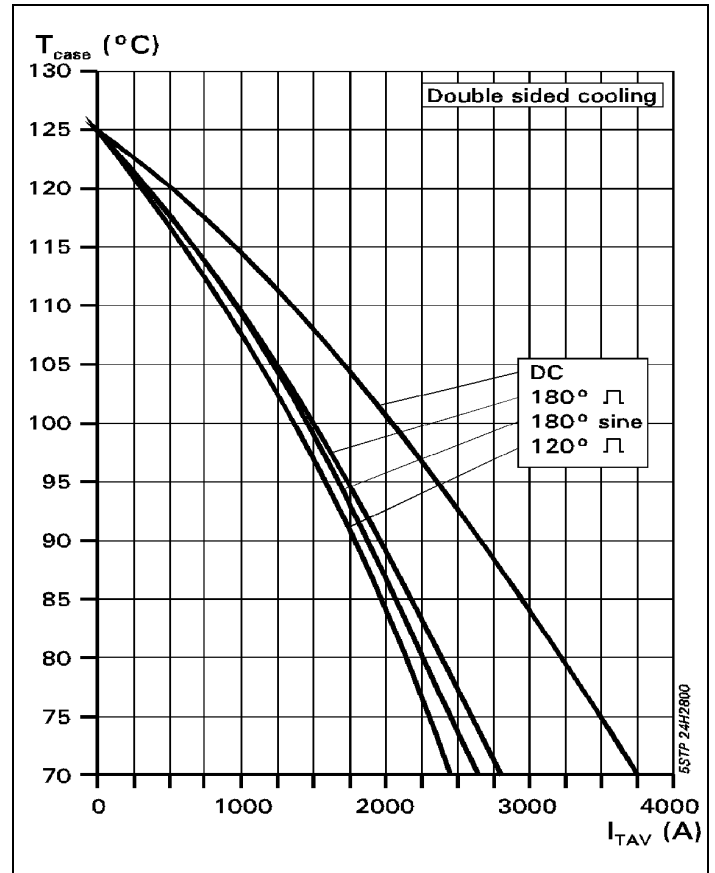

Fig. 3 On state characteristics.



**Fig. 4** On-state power dissipation vs. mean on-state current. Turn-on losses excluded.



**Fig. 5** Max. permissible case temperature vs. mean on-state current.

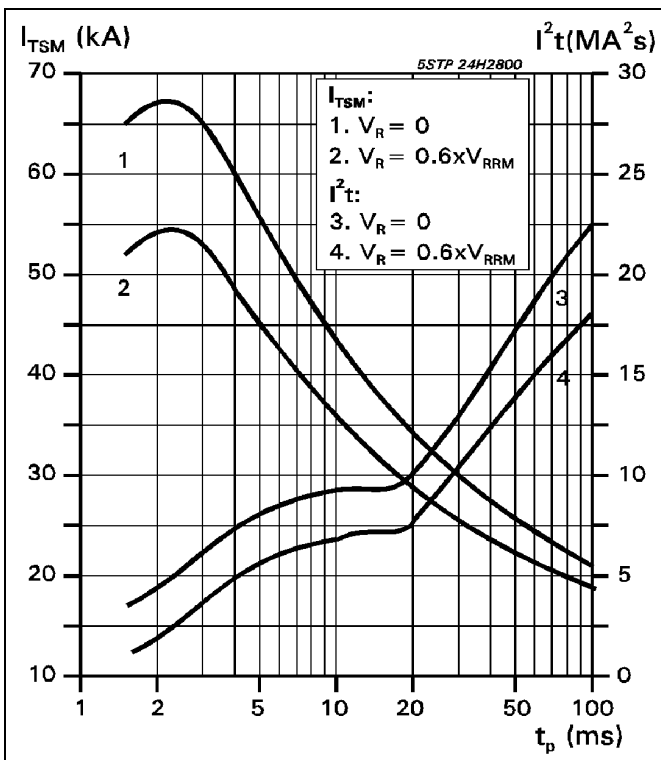

**Fig. 6** Surge on-state current vs. pulse length. Half-sine wave.

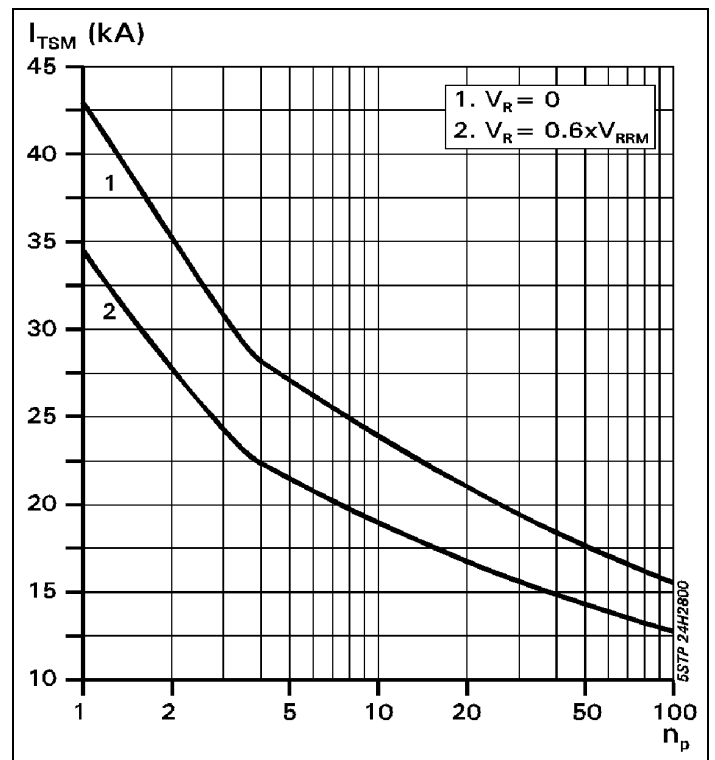

**Fig. 7** Surge on-state current vs. number of pulses. Half-sine wave, 10 ms, 50Hz.

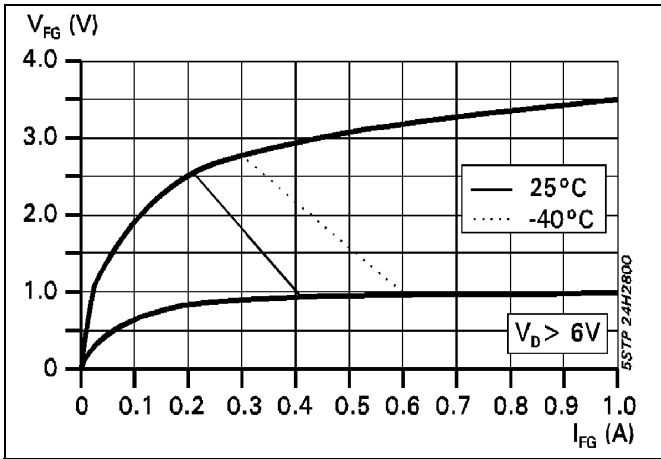

Fig. 8 Gate trigger characteristics.

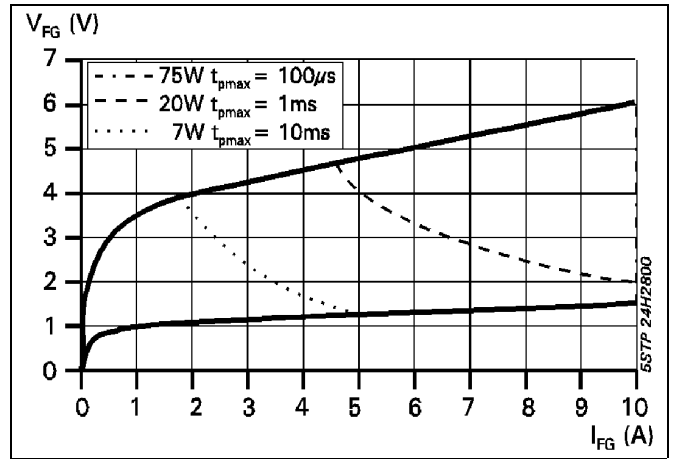

Fig. 9 Max. peak gate power loss.

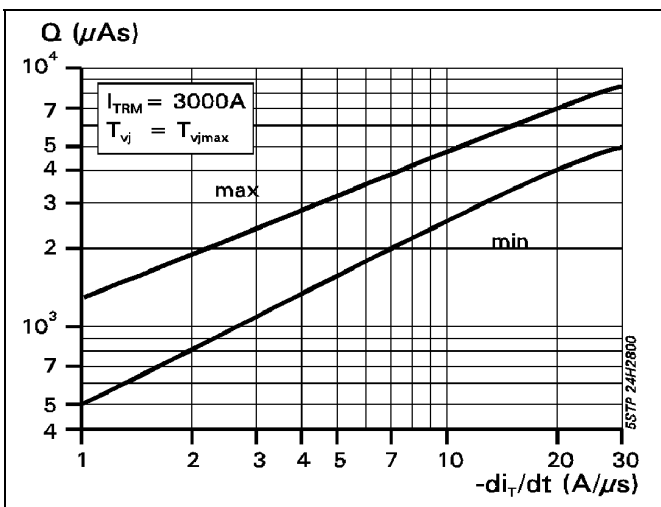

Fig. 10 Recovery charge vs. decay rate of on-state current.

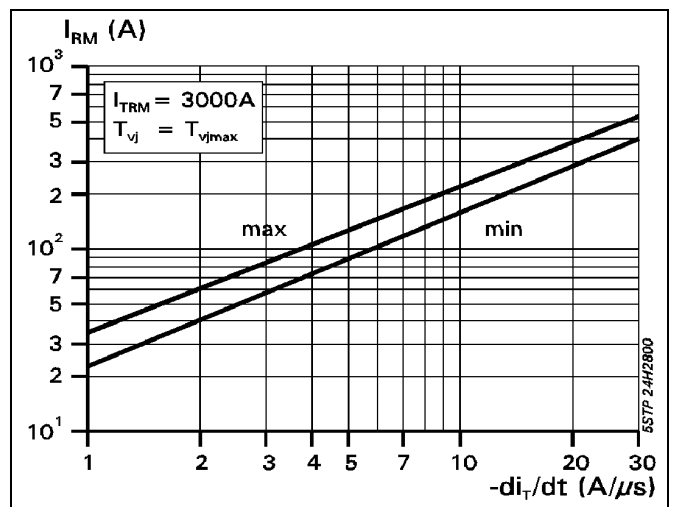

Fig. 11 Peak reverse recovery current vs. decay rate of on-state current.

ABB Semiconductors AG reserves the right to change specifications without notice.



ABB Semiconductors AG  
 Fabrikstrasse 3  
 CH-5600 Lenzburg, Switzerland

Telephone +41 62 888 6419  
 Fax +41 62 888 6306  
 E-mail info@ch.abb.com  
 Internet www.abbsem.com