



# 5STF 28H2060

## Fast Thyristor

### Properties

- Amplifying gate
- High operational capability
- Optimized turn-off parameters

### Applications

- Power switching applications

### Key Parameters

$V_{DRM}, V_{RRM}$	= 2 000	V
$I_{TAV}$	= 2 667	A
$I_{TSM}$	= 46.5	kA
$V_{TO}$	= 1.198	V
$r_T$	= 0.103	m $\Omega$
$t_q$	= 60	$\mu$ s

### Types

	$V_{RRM}, V_{DRM}$
<b>5STF 28H2060</b>	<b>2 000 V</b>
Conditions: $T_j = -40 \div 125$ °C, half sine waveform, $f = 50$ Hz, note 1	

### Mechanical Data

$F_m$	Mounting force	50 $\pm$ 5 kN
$m$	Weight	0.93 kg
$D_s$	Surface creepage distance	36 mm
$D_a$	Air strike distance	15 mm

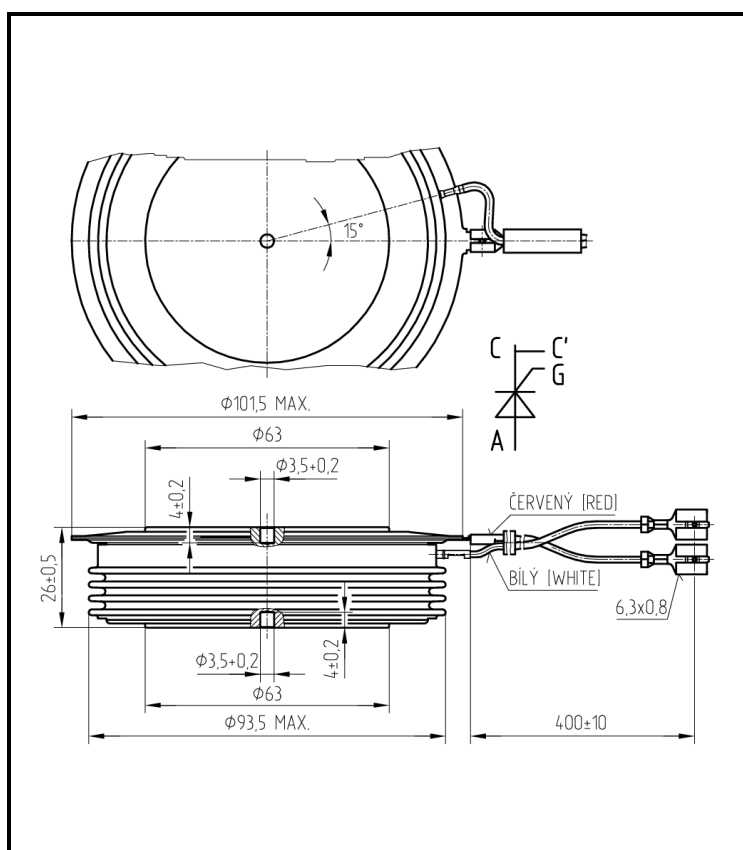

Fig. 1 Case



ABB s.r.o.

Novodvorska 1768/138a, 142 21 Praha 4, Czech Republic

tel.: +420 261 306 250, <http://www.abb.com/semiconductors>

<b>Maximum Ratings</b>		<b>Maximum Limits</b>	<b>Unit</b>
$V_{RRM}$ $V_{DRM}$	<b>Repetitive peak reverse and off-state voltage</b> $T_j = -40 \div 125 \text{ }^\circ\text{C}$ , note 1	<b>2 000</b>	<b>V</b>
$I_{TRMS}$	<b>RMS on-state current</b> $T_c = 70 \text{ }^\circ\text{C}$ , half sine waveform, $f = 50 \text{ Hz}$	<b>4 189</b>	<b>A</b>
$I_{TAVm}$	<b>Average on-state current</b> $T_c = 70 \text{ }^\circ\text{C}$ , half sine waveform, $f = 50 \text{ Hz}$	<b>2 667</b>	<b>A</b>
$I_{TSM}$	<b>Peak non-repetitive surge</b> half sine pulse, $V_R = 0 \text{ V}$	$t_p = 10 \text{ ms}$ <b>46 500</b> $t_p = 8.3 \text{ ms}$ <b>49 700</b>	<b>A</b>
$\hat{P}t$	<b>Limiting load integral</b> half sine pulse, $V_R = 0 \text{ V}$	$t_p = 10 \text{ ms}$ <b>10 810 000</b> $t_p = 8.3 \text{ ms}$ <b>10 250 000</b>	<b>A<sup>2</sup>s</b>
$(di_T/dt)_{cr}$	<b>Critical rate of rise of on-state current</b> $I_T = I_{TAVm}$ , half sine waveform, $f = 50 \text{ Hz}$ , $V_D = 2/3 V_{DRM}$ , $t_r = 0.3 \text{ } \mu\text{s}$ , $I_{GT} = 2 \text{ A}$	<b>800</b>	<b>A/<math>\mu\text{s}</math></b>
$(dv_D/dt)_{cr}$	<b>Critical rate of rise of off-state voltage</b> $V_D = 2/3 V_{DRM}$	<b>1 000</b>	<b>V/<math>\mu\text{s}</math></b>
$P_{GAVm}$	<b>Maximum average gate power losses</b>	<b>3</b>	<b>W</b>
$I_{FGM}$	<b>Peak gate current</b>	<b>10</b>	<b>A</b>
$V_{FGM}$	<b>Peak gate voltage</b>	<b>12</b>	<b>V</b>
$V_{RGM}$	<b>Reverse peak gate voltage</b>	<b>10</b>	<b>V</b>
$T_{jmin} - T_{jmax}$	<b>Operating temperature range</b>	<b>-40 <math>\div</math> 125</b>	<b><math>^\circ\text{C}</math></b>
$T_{stgmin} - T_{stgmax}$	<b>Storage temperature range</b>	<b>-40 <math>\div</math> 125</b>	<b><math>^\circ\text{C}</math></b>

Unless otherwise specified  $T_j = 125 \text{ }^\circ\text{C}$

Note 1: De-rating factor of 0.13%  $V_{RRM}$  or  $V_{DRM}$  per  $^\circ\text{C}$  is applicable for  $T_j$  below  $25 \text{ }^\circ\text{C}$

Characteristics			Value			Unit
			min.	typ.	max.	
$V_{TM}$	Maximum peak on-state voltage	$I_{TM} = 2\,000\text{ A}$ $I_{TM} = 4\,000\text{ A}$			1.350 1.610	V
$V_{T0}$	Threshold voltage				1.198	V
$r_T$	Slope resistance	$I_{T1} = 4\,188\text{ A}$ , $I_{T2} = 12\,563\text{ A}$			0.103	m $\Omega$
$I_{DM}$	Peak off-state current	$V_D = V_{DRM}$			150	mA
$I_{RM}$	Peak reverse current	$V_R = V_{RRM}$			150	mA
$t_{gd}$	Delay time	$T_j = 25\text{ }^\circ\text{C}$ , $V_D = 0.4 V_{DRM}$ , $I_{TM} = I_{TAVm}$ , $t_r = 0.3\text{ }\mu\text{s}$ , $I_{GT} = 2\text{ A}$			2.0	$\mu\text{s}$
$t_{q1}$	Turn-off time	$I_T = 1\,000\text{ A}$ , $di_T/dt = -50\text{ A}/\mu\text{s}$ , $V_R = 100\text{ V}$ , $V_D = 2/3 V_{DRM}$ , $dv_D/dt = 50\text{ V}/\mu\text{s}$			60.0	$\mu\text{s}$
$t_{q2}$	Turn-off time	$I_T = 1\,000\text{ A}$ , $di_T/dt = -25\text{ A}/\mu\text{s}$ , $V_R = 100\text{ V}$ , $V_D = 2/3 V_{DRM}$ , $dv_D/dt = 400\text{ V}/\mu\text{s}$			80.0	$\mu\text{s}$
$Q_{rr}$	Recovery charge	the same conditions as at $t_{q1}$			2400	$\mu\text{C}$
$I_{rrM}$	Reverse recovery current	the same conditions as at $t_{q1}$			315	A
$I_H$	Holding current	$T_j = 25\text{ }^\circ\text{C}$ $T_j = 125\text{ }^\circ\text{C}$			250 150	mA
$I_L$	Latching current	$T_j = 25\text{ }^\circ\text{C}$ $T_j = 125\text{ }^\circ\text{C}$			500 300	mA
$V_{GT}$	Gate trigger voltage	$T_j = -40\text{ }^\circ\text{C}$ $T_j = 25\text{ }^\circ\text{C}$ $T_j = 125\text{ }^\circ\text{C}$		0.25	4 3 2	V
$I_{GT}$	Gate trigger current	$T_j = -40\text{ }^\circ\text{C}$ $T_j = 25\text{ }^\circ\text{C}$ $T_j = 125\text{ }^\circ\text{C}$		10	1000 500 300	mA

Unless otherwise specified  $T_j = 125\text{ }^\circ\text{C}$

Thermal Parameters		Value	Unit
$R_{thjc}$	<b>Thermal resistance junction to case</b> <i>double side cooling</i>	<b>10.0</b>	<b>K/kW</b>
	<i>anode side cooling</i>	<b>16.0</b>	
	<i>cathode side cooling</i>	<b>26.5</b>	
$R_{thch}$	<b>Thermal resistance case to heatsink</b> <i>double side cooling</i>	<b>3.0</b>	<b>K/kW</b>
	<i>single side cooling</i>	<b>6.0</b>	

### Transient Thermal Impedance

Analytical function for transient thermal impedance

$$Z_{thjc} = \sum_{i=1}^5 R_i (1 - \exp(-t/\tau_i))$$

Conditions:

$F_m = 50 \pm 5$  kN, Double side cooled

Correction for periodic waveforms

180° sine:	add 1.0 K/kW
180° rectangular:	add 1.0 K/kW
120° rectangular:	add 1.5 K/kW
60° rectangular:	add 3.0 K/kW

$i$	1	2	3	4	5
$\tau_i$ (s)	0.4871	0.1468	0.0677	0.0079	0.0021
$R_i$ (K/kW)	6.73	1.44	0.65	0.84	0.32

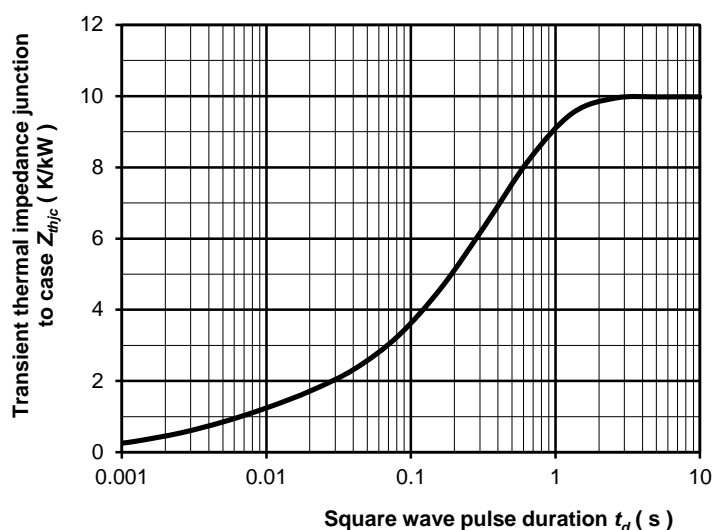
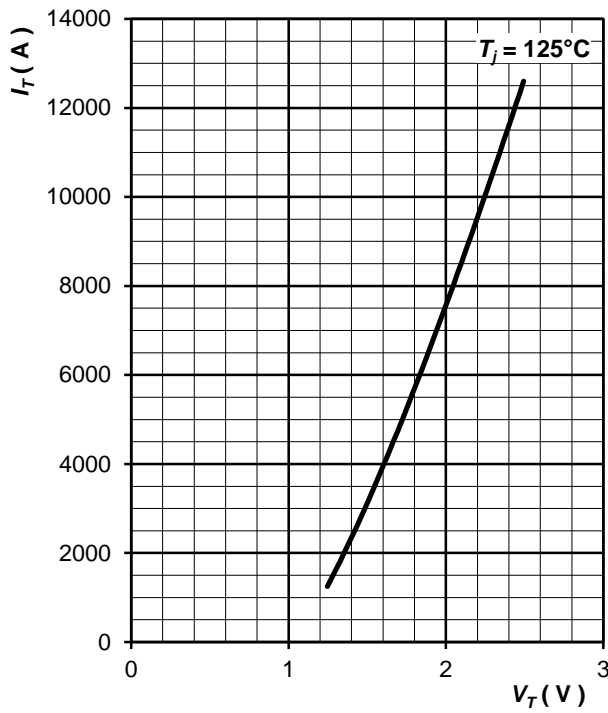

Fig. 2 Dependence transient thermal impedance junction to case on square pulse

**On-State Characteristics**



Analytical function for on-state characteristics:

$$V_T = A + B \cdot I_T + C \cdot \sqrt{I_T} + D \cdot \ln(I_T + 1)$$

$T_j$ (°C)	125
<b>A</b>	0.57536
<b>B</b>	0.00008
<b>C</b>	0.00194
<b>D</b>	0.06964

Fig. 3 Maximum on-state characteristics

**Gate Trigger Characteristics**

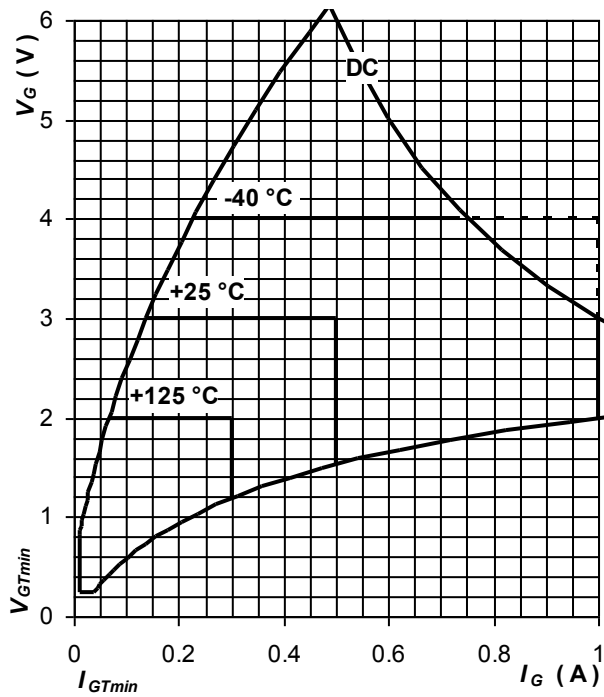

Fig. 4 Gate trigger characteristics

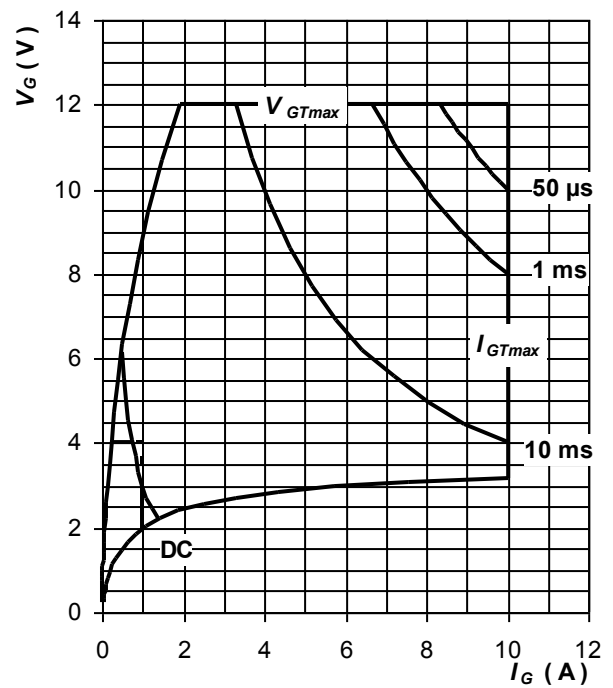

Fig. 5 Maximum peak gate power loss

## Surge Characteristics

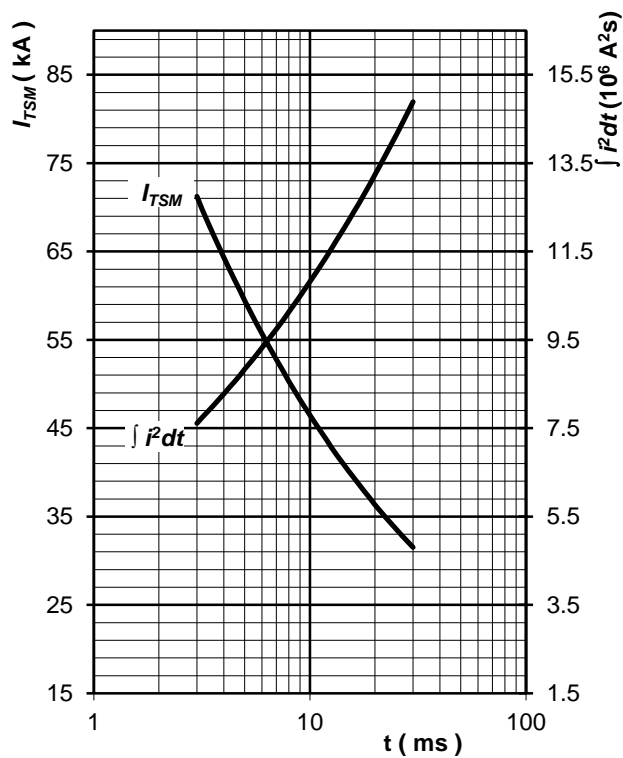

Fig. 6 Surge on-state current vs. pulse length, half sine wave, single pulse,  $V_R = 0 V$ ,  $T_j = T_{jmax}$

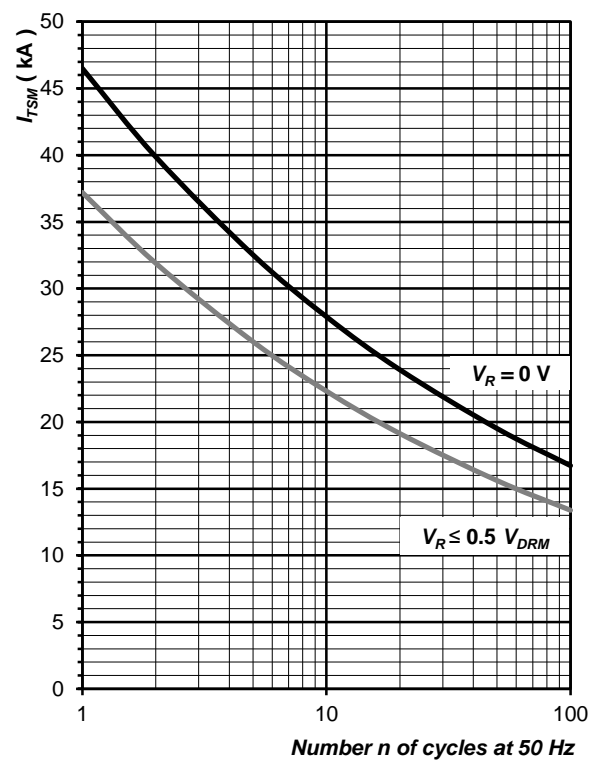

Fig. 7 Surge on-state current vs. number of pulses, half sine wave,  $T_j = T_{jmax}$

**Power Loss and Maximum Case Temperature Characteristics**

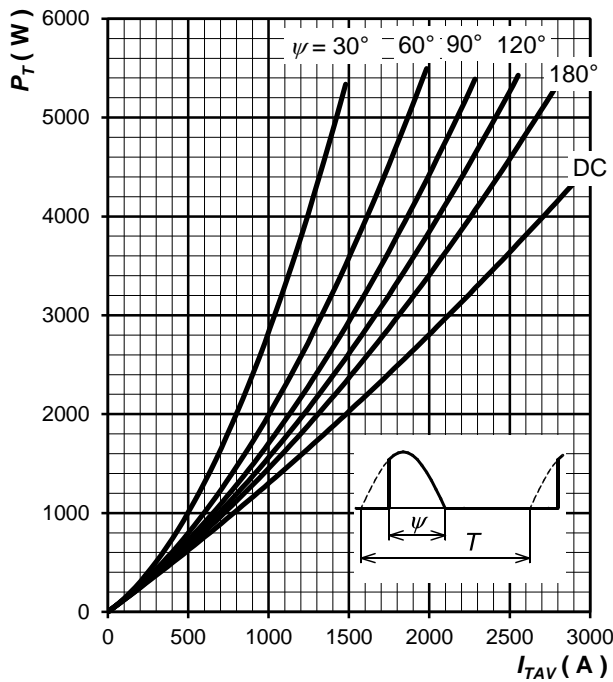

Fig. 8 On-state power loss vs. average on-state current, sine waveform,  $f = 50 \text{ Hz}$ ,  $T = 1/f$

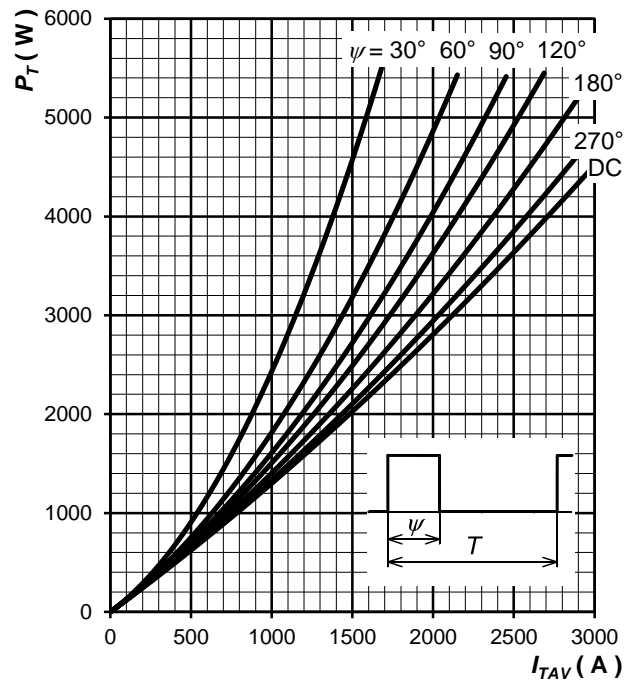

Fig. 9 On-state power loss vs. average on-state current, square waveform,  $f = 50 \text{ Hz}$ ,  $T = 1/f$

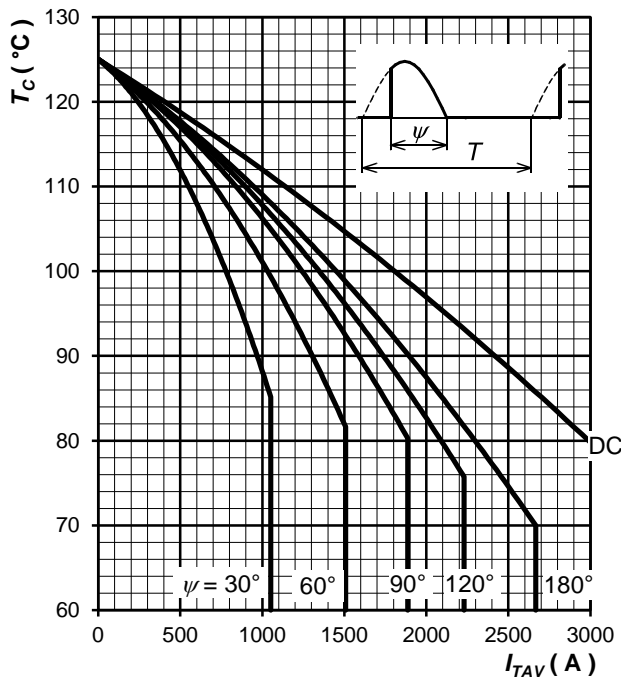

Fig. 10 Max. case temperature vs. aver. on-state current, sine waveform,  $f = 50 \text{ Hz}$ ,  $T = 1/f$

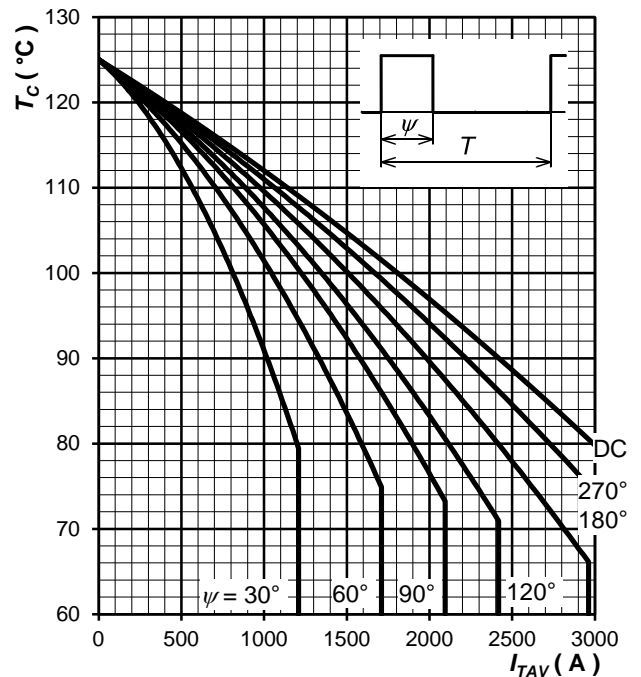

Fig. 11 Max. case temperature vs. aver. on-state current, square waveform,  $f = 50 \text{ Hz}$ ,  $T = 1/f$

Note 2: Figures number 8 ÷ 11 have been calculated without considering any turn-on and turn-off losses. They are valid for  $f = 50$  or  $60 \text{ Hz}$  operation.

**Turn-off Time, Parameter Relationship**

Maximum values of turn-off time at application specific conditions are given by using this formula:

$$t_q = t_{q1} \cdot \frac{t_q}{t_{q1}}(T_j) \cdot \frac{t_q}{t_{q1}}(dv_D / dt) \cdot \frac{t_q}{t_{q1}}(-di_T / dt)$$

where:

$t_{q1}$  is turn-off time at standard conditions, see section "Characteristics"

$\frac{t_q}{t_{q1}}(T_j)$  is factor to be taken from fig. 12

$\frac{t_q}{t_{q1}}(dv_D / dt)$  is factor to be taken from fig. 13

$\frac{t_q}{t_{q1}}(-di_T / dt)$  is factor to be taken from fig. 14

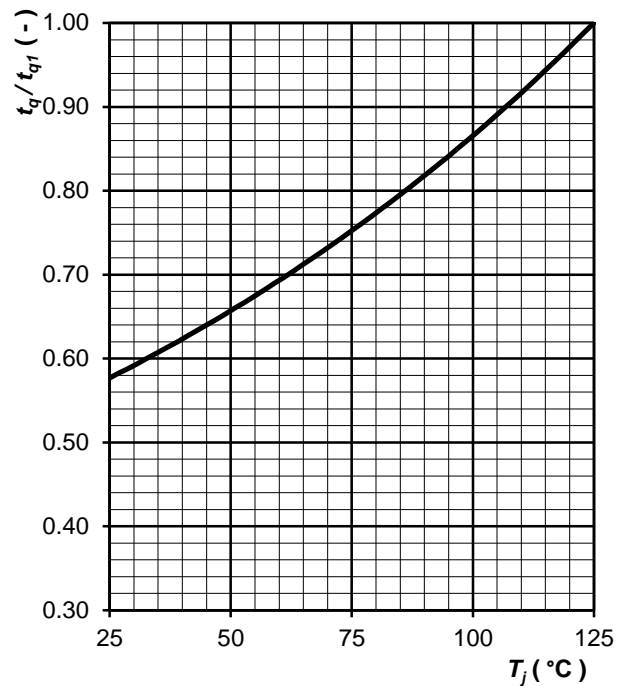

Fig. 12 Normalised maximum turn-off time vs. junction temperature

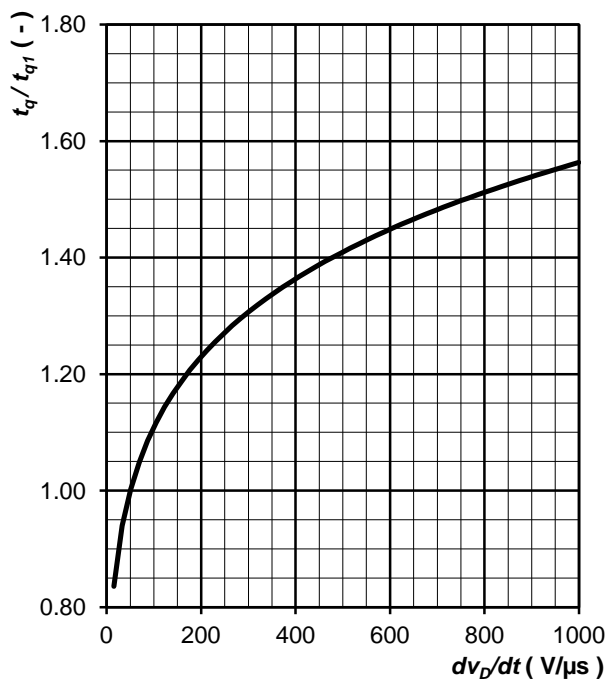

Fig. 13 Normalised maximum turn-off time vs. rate of rise of off-state voltage

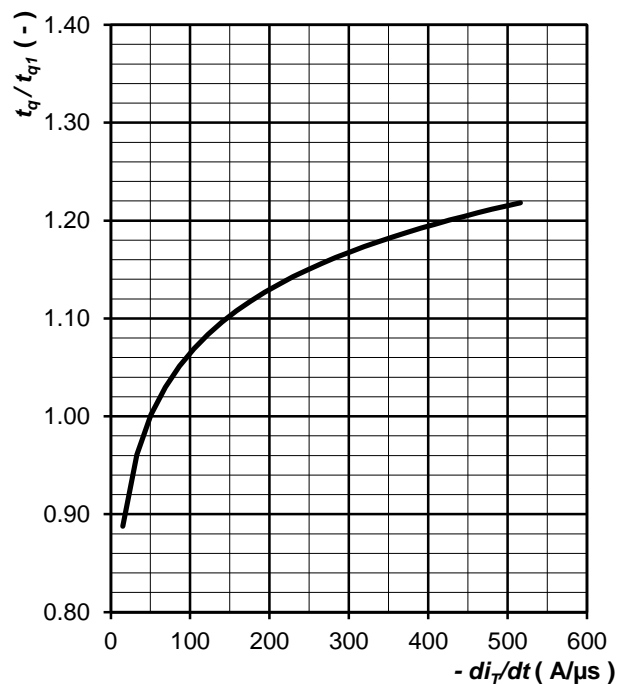

Fig. 14 Normalised maximum turn-off time vs. rate of fall of on-state current



**Turn-off Characteristics**

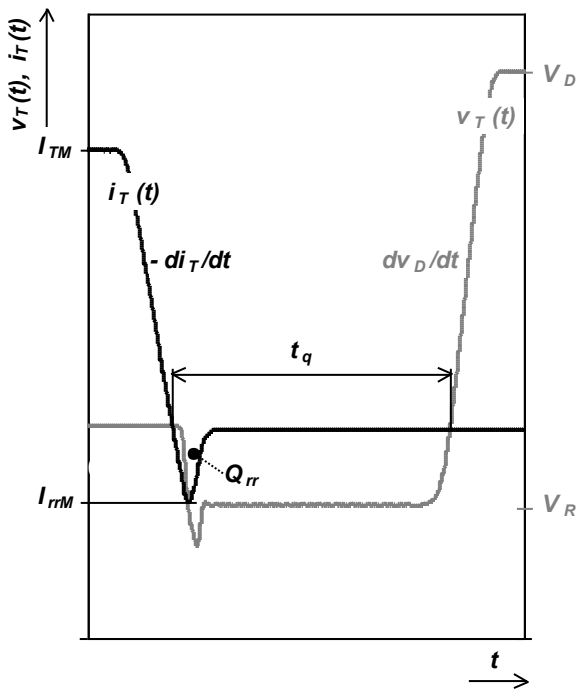

Fig. 17 Typical waveforms and definition of symbols at turn-off of a thyristor, inductive switching without RC snubber

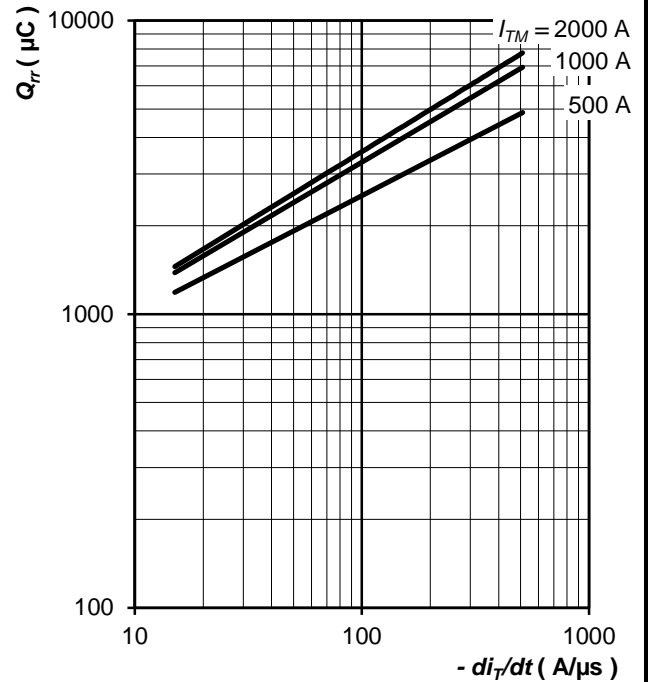

Fig. 18 Max. recovered charge vs. rate of fall on-state current, trapezoid pulse,  $V_R = 100 \text{ V}$ ,  $T_j = T_{jmax}$

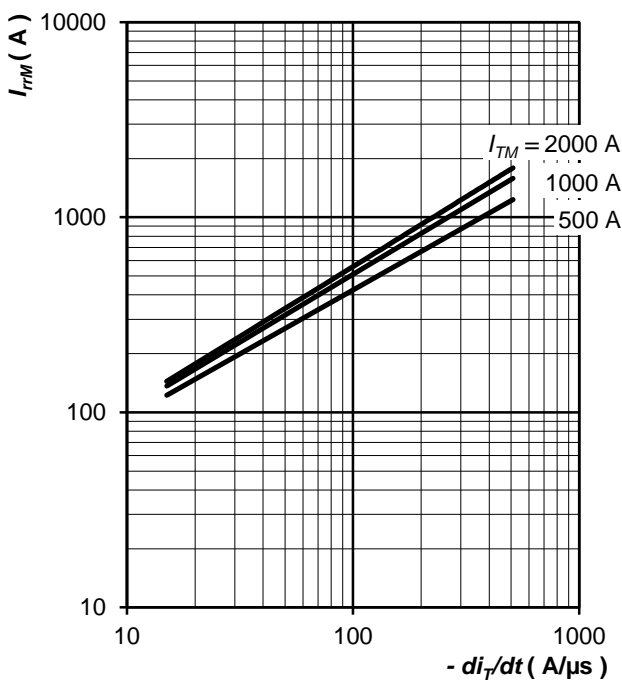

Fig. 19 Max. reverse recovery current vs. rate of fall on-state current, trapezoid pulse,  $V_R = 100 \text{ V}$ ,  $T_j = T_{jmax}$

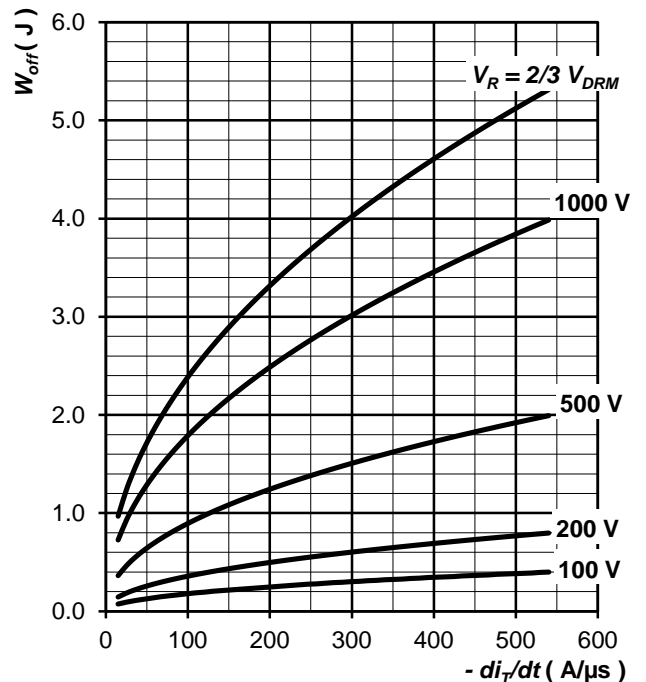

Fig. 20 Maximum turn-off energy per pulse vs. rate of fall on-state current, trapezoid pulse, inductive switching without RC snubber,  $I_{TM} = 2\ 000 \text{ A}$ ,  $T_j = T_{jmax}$

Notes:

ABB s.r.o., Novodvorska 1768/138a, 142 21 Praha 4, Czech Republic

ABB s.r.o. reserves the right to change the data contained herein at any time without notice