

Data sheet 5SYA 1486-01 May 22

5SNG 0900R120590

LoPak phase leg IGBT module

- $V_{CE} = 1200\text{ V}$
- $I_C = 2 \times 900\text{ A}$
- Press-fit pins for reliable auxiliary contacts
- Ultra low-loss rugged Trench IGBT chipset
- NTC thermistor for temperature sensing
- Cu baseplate for low thermal resistance
- Pre-Applied Thermal Interface Material (TIM) to improve thermal conductivity between module and heat sink
- Industry standard package



Maximum rated values ¹⁾

Parameter	Symbol	Conditions	Min.	Max.	Unit
Collector-emitter voltage	V_{CES}	$V_{GE} = 0\text{ V}$, $T_{vj} \geq 25\text{ °C}$		1200	V
DC collector current	I_C	$T_C = 105\text{ °C}$, $T_{vj} = 175\text{ °C}$		900	A
Peak collector current	I_{CM}	$t_p = 1\text{ ms}$		1800	A
Maximum RMS current per DC terminal	I_{TRMS}	Per DC terminal, $T_C = 90\text{ °C}$, $T_{Terminal} \leq 90\text{ °C}$		580	A
Gate-emitter voltage	V_{GES}		-20	20	V
DC forward current	I_F			900	A
Peak forward current	I_{FRM}	$t_p = 1\text{ ms}$		1800	A
Surge current	I_{FSM}	$T_{vj, start} = 175\text{ °C}$, $t_p = 10\text{ ms}$, half-sinewave		3000	A
IGBT short circuit SOA	t_{psc}	$V_{GE} \leq 15\text{ V}$, $V_{CC} = 900\text{ V}$ $V_{CE, max} \leq 1200\text{ V}$	$T_{vj, start} \leq 150\text{ °C}$	8	μs
			$T_{vj, start} \leq 175\text{ °C}$	6	
Isolation voltage	V_{isol}	1 min, $f = 50\text{ Hz}$		4000	V
Max Junction temperature	T_{vj}		-40	175	$^{\circ}\text{C}$
Junction operating temperature	$T_{vj(op)}$		-40	175	$^{\circ}\text{C}$
Case temperature	T_C		-40	125 ²⁾ / 150	$^{\circ}\text{C}$
Storage temperature	T_{stg}		-40	125	$^{\circ}\text{C}$
Mounting torques ³⁾	M_s	Base- heatsink, M5 screws	3	6	Nm
	M_{t1}	Main terminals, M6 screws	3	6	

¹⁾ Maximum rated values indicate limits beyond which damage to the device may occur per IEC 60747

²⁾ For UL1557 compliance T_{Cmax} must be limited to 125 $^{\circ}\text{C}$

³⁾ For detailed mounting instructions refer to application note 5SYA 2142

IGBT characteristic values ⁴⁾

Parameter	Symbol	Conditions	Min.	Typ.	Max.	Unit
Collector-emitter breakdown voltage	$V_{(BR)CES}$	$V_{GE} = 0\text{ V}$, $I_C = 5\text{ mA}$	$T_{vj} = 25\text{ °C}$	1200		V
Collector-emitter ⁵⁾ saturation voltage	V_{CEsat}	$I_C = 900\text{ A}$, $V_{GE} = 15\text{ V}$	$T_{vj} = 25\text{ °C}$	1.53		V
			$T_{vj} = 125\text{ °C}$	1.71		V
			$T_{vj} = 175\text{ °C}$	1.83		V
Collector cut-off current	I_{CES}	$V_{CE} = 1200\text{ V}$, $V_{GE} = 0\text{ V}$	$T_{vj} = 25\text{ °C}$		0.1	mA
			$T_{vj} = 125\text{ °C}$	0.7		mA
			$T_{vj} = 175\text{ °C}$	17		mA
Gate leakage current	I_{GES}	$V_{CE} = 0\text{ V}$, $V_{GE} = \pm 20\text{ V}$	$T_{vj} = 125\text{ °C}$	-150	150	nA
Gate-emitter threshold voltage	$V_{GE(th)}$	$I_C = 36\text{ mA}$, $V_{CE} = V_{GE}$	$T_{vj} = 25\text{ °C}$	5.5		V
Gate charge	Q_G	$I_C = 900\text{ A}$, $V_{CE} = 600\text{ V}$, $V_{GE} = -15\text{ V}..15\text{ V}$		6.1		μC
Input capacitance	C_{ies}	per switch	$T_{vj} = 25\text{ °C}$	114		nF
Internal gate resistance	$R_{g,int}$	per switch		1.3		Ω
Turn-on delay time	$t_{d(on)}$	$V_{CC} = 600\text{ V}$, $I_C = 900\text{ A}$, $R_G = 0.51\ \Omega$, $C_{GE} = 0\text{ nF}$, $V_{GE} = \pm 15\text{ V}$, $L_\sigma = 25\text{ nH}$, inductive load	$T_{vj} = 25\text{ °C}$	435		ns
			$T_{vj} = 125\text{ °C}$	500		ns
			$T_{vj} = 175\text{ °C}$	528		ns
Rise time	t_r	$V_{CC} = 600\text{ V}$, $I_C = 900\text{ A}$, $R_G = 0.51\ \Omega$, $C_{GE} = 0\text{ nF}$, $V_{GE} = \pm 15\text{ V}$, $L_\sigma = 25\text{ nH}$, inductive load	$T_{vj} = 25\text{ °C}$	135		ns
			$T_{vj} = 125\text{ °C}$	180		ns
			$T_{vj} = 175\text{ °C}$	202		ns
Turn-off delay time	$t_{d(off)}$	$V_{CC} = 600\text{ V}$, $I_C = 900\text{ A}$, $R_G = 0.51\ \Omega$, $C_{GE} = 0\text{ nF}$, $V_{GE} = \pm 15\text{ V}$, $L_\sigma = 25\text{ nH}$, inductive load	$T_{vj} = 25\text{ °C}$	395		ns
			$T_{vj} = 125\text{ °C}$	418		ns
			$T_{vj} = 175\text{ °C}$	437		ns
Fall time	t_f	$V_{CC} = 600\text{ V}$, $I_C = 900\text{ A}$, $R_G = 0.51\ \Omega$, $C_{GE} = 0\text{ nF}$, $V_{GE} = \pm 15\text{ V}$, $L_\sigma = 25\text{ nH}$, inductive load	$T_{vj} = 25\text{ °C}$	140		ns
			$T_{vj} = 125\text{ °C}$	162		ns
			$T_{vj} = 175\text{ °C}$	176		ns
Turn-on switching energy	E_{on}	$V_{CC} = 600\text{ V}$, $I_C = 900\text{ A}$, $R_G = 0.51\ \Omega$, $C_{GE} = 0\text{ nF}$, $V_{GE} = \pm 15\text{ V}$, $L_\sigma = 25\text{ nH}$, inductive load	$T_{vj} = 25\text{ °C}$	153		mJ
			$T_{vj} = 125\text{ °C}$	220		mJ
			$T_{vj} = 175\text{ °C}$	267		mJ
Turn-off switching energy	E_{off}	$V_{CC} = 600\text{ V}$, $I_C = 900\text{ A}$, $R_G = 0.51\ \Omega$, $C_{GE} = 0\text{ nF}$, $V_{GE} = \pm 15\text{ V}$, $L_\sigma = 25\text{ nH}$, inductive load	$T_{vj} = 25\text{ °C}$	122		mJ
			$T_{vj} = 125\text{ °C}$	160		mJ
			$T_{vj} = 175\text{ °C}$	178		mJ
Short circuit current	I_{SC}	$V_{CC} = 900\text{ V}$, $V_{GE} = 15\text{ V}$, $V_{CEM\ CHIP} \leq 1200\text{ V}$	$T_{vj} = 175\text{ °C}$	3550		A

⁴⁾ Characteristic values according to IEC 60747 – 9

⁵⁾ Collector-emitter saturation voltage is given at chip level

Hitachi Energy Switzerland Ltd
Semiconductors
Fabrikstrasse 3
5600 Lenzburg
Switzerland
Tel: +41 58 586 10 00

E-Mail: salesdesksem@hitachienergy.com

We reserve the right to make technical changes or modify the contents of this document without prior notice. With regard to purchase orders, the agreed particulars shall prevail.

Hitachi Energy Ltd. does not accept any responsibility whatsoever for potential errors or possible lack of information in this document.

We reserve all rights in this document and in the subject matter and illustrations contained therein. Any reproduction, disclosure to third parties or utilization of its contents – in whole or in parts – is forbidden without prior written consent of Hitachi Energy Ltd.

Diode characteristic values ⁶⁾

Parameter	Symbol	Conditions	Min.	Typ.	Max.	Unit
Forward voltage ⁷⁾	V _F	I _F = 900 A	T _{vj} = 25 °C	1.67		V
			T _{vj} = 125 °C	1.71		V
			T _{vj} = 175 °C	1.65		V
Peak reverse recovery current	I _{RM}		T _{vj} = 25 °C	502		A
			T _{vj} = 125 °C	518		A
			T _{vj} = 175 °C	543		A
Recovered charge	Q _{rr}	V _{CC} = 600 V, I _F = 900 A, V _{GE} = ±15 V, R _G = 0.51 Ω, C _{GE} = 0 nF, L _σ = 25 nH, di/dt = 4.3 kA / μs, inductive load	T _{vj} = 25 °C	78		μC
			T _{vj} = 125 °C	128		μC
			T _{vj} = 175 °C	173		μC
Reverse recovery time	t _{rr}		T _{vj} = 25 °C	297		ns
			T _{vj} = 125 °C	553		ns
			T _{vj} = 175 °C	680		ns
Reverse recovery energy	E _{rec}		T _{vj} = 25 °C	19		mJ
			T _{vj} = 125 °C	33		mJ
			T _{vj} = 175 °C	46		mJ

⁶⁾ Characteristic values according to IEC 60747 – 2

⁷⁾ Forward voltage is given at chip level

NTC Thermistor

Parameter	Symbol	Conditions	Min.	Typ.	Max.	Unit
Rated resistance	R ₂₅	T _c = 25 °C		5		kΩ
R100	R ₁₀₀	T _c = 100 °C	468		517	Ω
B-value	B _{25/85}	R ₂₅ = R ₂₅ exp [B _{25/85} (1/T ₂ – 1/(298.15K))]		3375		K
B-value	B _{25/100}	R ₂₅ = R ₂₅ exp [B _{25/100} (1/T ₂ – 1/(298.15K))]		3433		K

Hitachi Energy Switzerland Ltd
Semiconductors
Fabrikstrasse 3
5600 Lenzburg
Switzerland
Tel: +41 58 586 10 00

E-Mail: salesdesksem@hitachienergy.com

We reserve the right to make technical changes or modify the contents of this document without prior notice. With regard to purchase orders, the agreed particulars shall prevail.

Hitachi Energy Ltd. does not accept any responsibility whatsoever for potential errors or possible lack of information in this document.

We reserve all rights in this document and in the subject matter and illustrations contained therein. Any reproduction, disclosure to third parties or utilization of its contents – in whole or in parts – is forbidden without prior written consent of Hitachi Energy Ltd.

Package properties

Parameter	Symbol	Conditions	Min.	Typ.	Max.	Unit
IGBT thermal resistance junction to case	$R_{th(j-c)IGBT}$	per switch			0.043	K/W
Diode thermal resistance junction to case	$R_{th(j-c)DIODE}$	per switch			0.095	K/W
IGBT thermal resistance case to heatsink ⁸⁾	$R_{th(c-s)IGBT}$	IGBT per switch, I TIM = 5.2 W/m x K		0.025		K/W
Diode thermal resistance case to heatsink ⁸⁾	$R_{th(c-s)DIODE}$	Diode per switch, I TIM = 5.2 W/m x K		0.032		K/W
Comparative tracking index	CTI		200			
Module stray inductance	$L_{\sigma CE}$	per switch		20		nH
Resistance, terminal-chip	R_{CC+EE}	per switch	$T_C = 25\text{ °C}$	0.95		mΩ
			$T_C = 125\text{ °C}$	1.35		
			$T_C = 175\text{ °C}$	1.55		

⁸⁾ Depends on heatsink design

Mechanical properties ⁹⁾

Parameter	Symbol	Conditions	Min.	Typ.	Max.	Unit
Dimensions	L x W x H	Typical		152 x 62 x 17		mm
Clearance distance in air	d_a	According to IEC 60664-1 and EN 50124-1	Term. to base:	12.5		mm
			Term. to base:	10		
Surface creepage distance	d_s	According to IEC 60664-1 and EN 50124-1	Term. to base:	14.5		mm
			Term. to base:	13		
Mass	m			350		g

⁹⁾ Package and mechanical properties according to IEC 60747 – 15

Hitachi Energy Switzerland Ltd
Semiconductors
Fabrikstrasse 3
5600 Lenzburg
Switzerland
Tel: +41 58 586 10 00

E-Mail: salesdesksem@hitachienergy.com

We reserve the right to make technical changes or modify the contents of this document without prior notice. With regard to purchase orders, the agreed particulars shall prevail.

Hitachi Energy Ltd. does not accept any responsibility whatsoever for potential errors or possible lack of information in this document.

We reserve all rights in this document and in the subject matter and illustrations contained therein. Any reproduction, disclosure to third parties or utilization of its contents – in whole or in parts – is forbidden without prior written consent of Hitachi Energy Ltd.

Electrical configuration

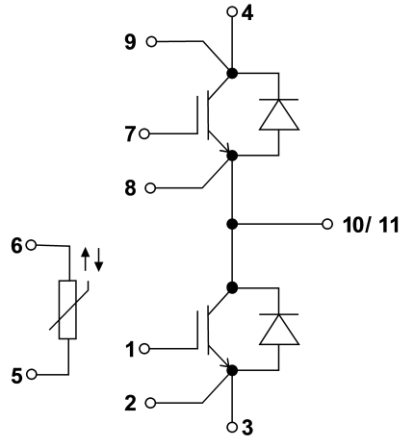

Mechanical drawing

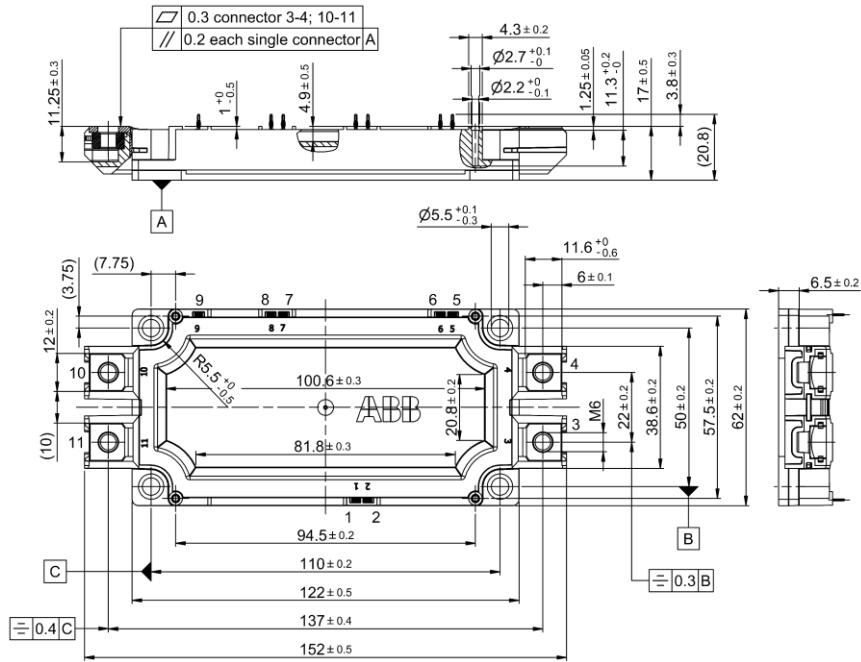

PCB drill hole pattern for press-fit

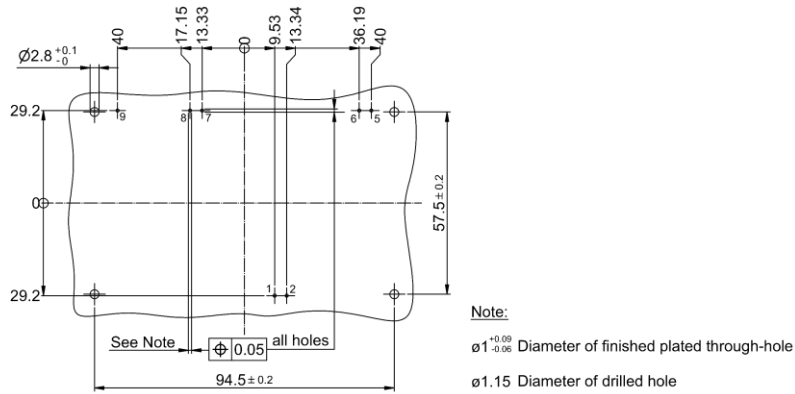

Note: all dimensions are shown in millimeters

Hitachi Energy Switzerland Ltd
Semiconductors
Fabrikstrasse 3
5600 Lenzburg
Switzerland
Tel: +41 58 586 10 00

E-Mail: salesdesksem@hitachienergy.com

We reserve the right to make technical changes or modify the contents of this document without prior notice. With regard to purchase orders, the agreed particulars shall prevail.

Hitachi Energy Ltd. does not accept any responsibility whatsoever for potential errors or possible lack of information in this document.

We reserve all rights in this document and in the subject matter and illustrations contained therein. Any reproduction, disclosure to third parties or utilization of its contents – in whole or in parts – is forbidden without prior written consent of Hitachi Energy Ltd.

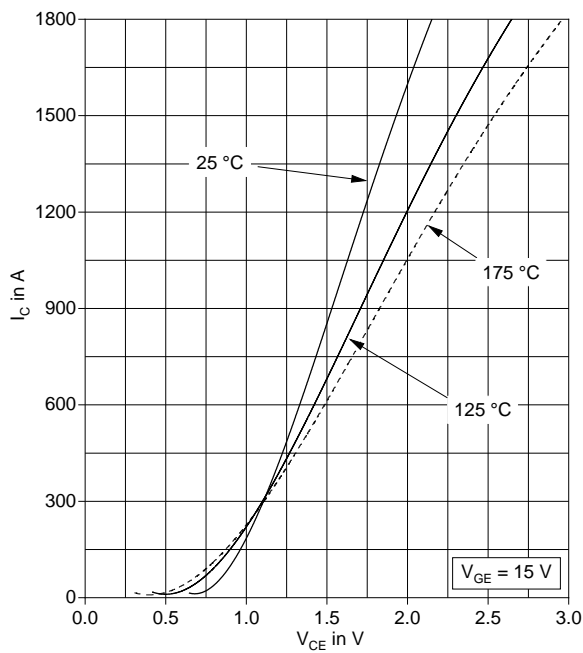

Fig. 1 Typical on-state characteristics, chip level

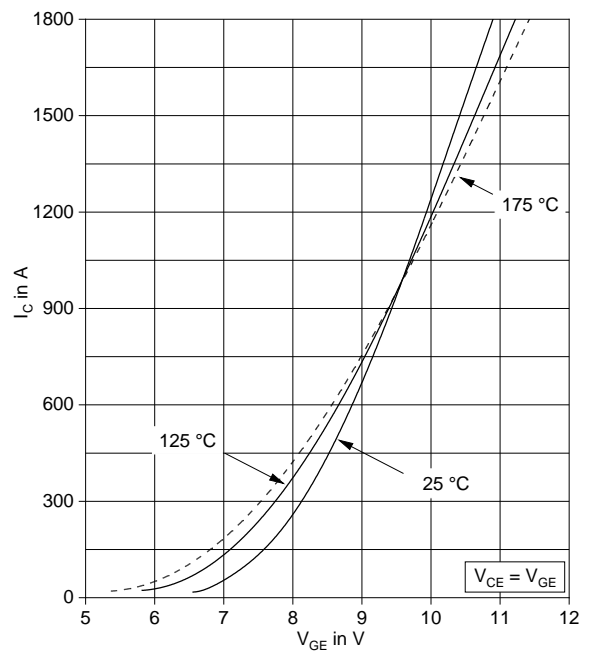

Fig. 2 Typical transfer characteristics, chip level

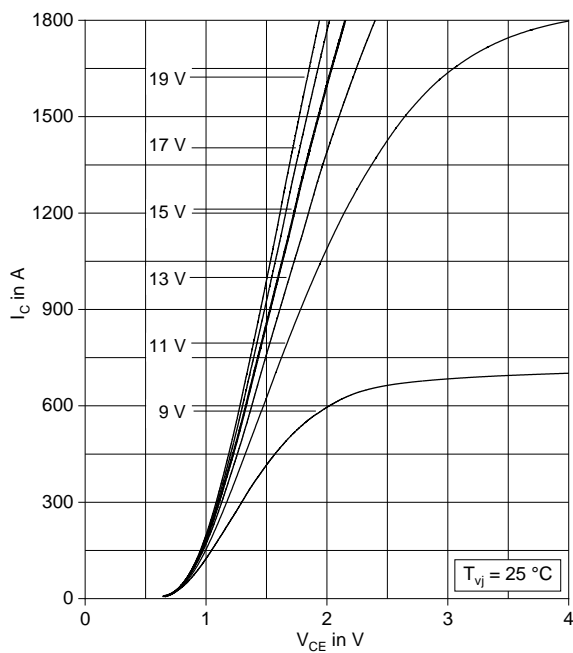

Fig. 3 Typical output characteristics, chip level

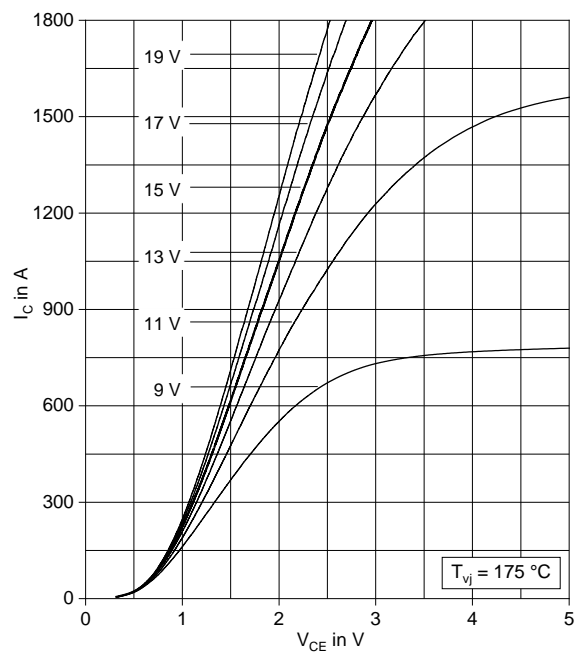

Fig. 4 Typical output characteristics, chip level

Hitachi Energy Switzerland Ltd
Semiconductors
Fabrikstrasse 3
5600 Lenzburg
Switzerland
Tel: +41 58 586 10 00

E-Mail: salesdesksem@hitachienergy.com

www.hitachienergy.com/semiconductors

We reserve the right to make technical changes or modify the contents of this document without prior notice. With regard to purchase orders, the agreed particulars shall prevail.

Hitachi Energy Ltd. does not accept any responsibility whatsoever for potential errors or possible lack of information in this document.

We reserve all rights in this document and in the subject matter and illustrations contained therein. Any reproduction, disclosure to third parties or utilization of its contents – in whole or in parts – is forbidden without prior written consent of Hitachi Energy Ltd.

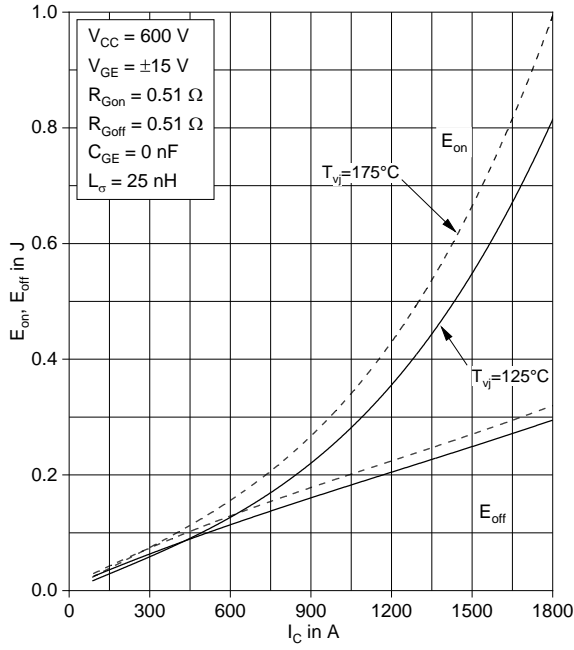

Fig. 5 Typical switching energies per pulse vs. collector current

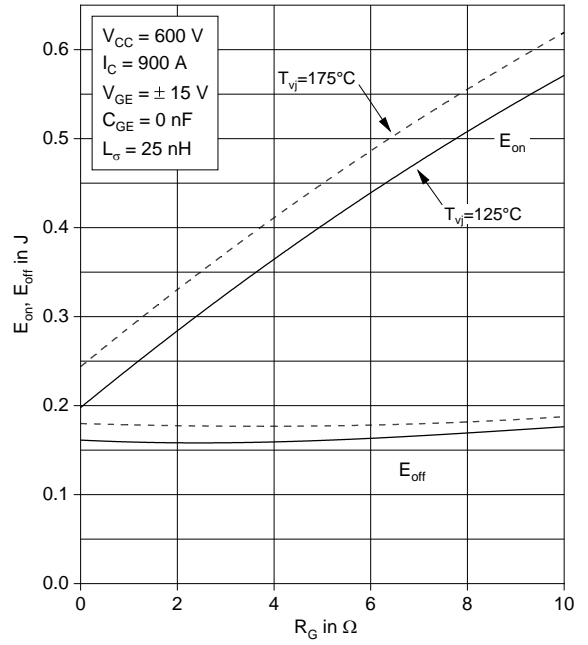

Fig. 6 Typical switching energies per pulse vs. gate resistor

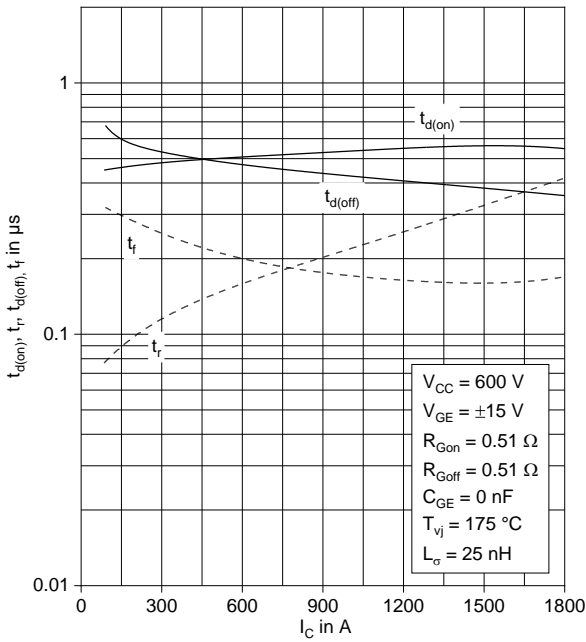

Fig. 7 Typical switching times vs. collector current

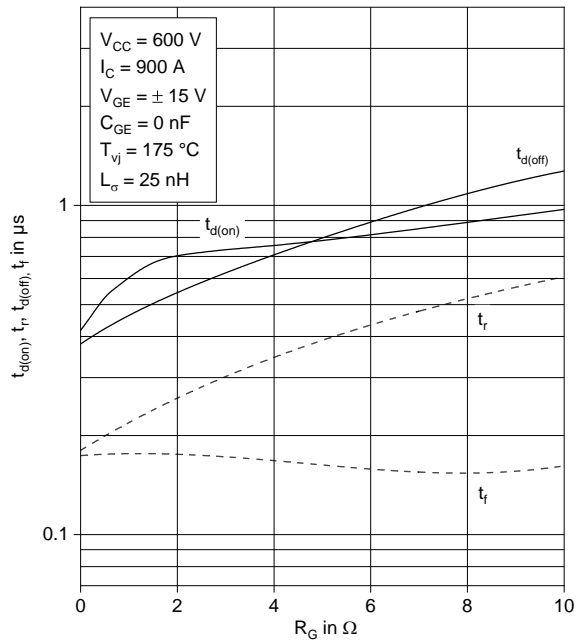

Fig. 8 Typical switching times vs. gate resistor

Hitachi Energy Switzerland Ltd
 Semiconductors
 Fabrikstrasse 3
 5600 Lenzburg
 Switzerland
 Tel: +41 58 586 10 00

E-Mail: salesdesksem@hitachienergy.com

www.hitachienergy.com/semiconductors

We reserve the right to make technical changes or modify the contents of this document without prior notice. With regard to purchase orders, the agreed particulars shall prevail.

Hitachi Energy Ltd. does not accept any responsibility whatsoever for potential errors or possible lack of information in this document.

We reserve all rights in this document and in the subject matter and illustrations contained therein. Any reproduction, disclosure to third parties or utilization of its contents – in whole or in parts – is forbidden without prior written consent of Hitachi Energy Ltd.

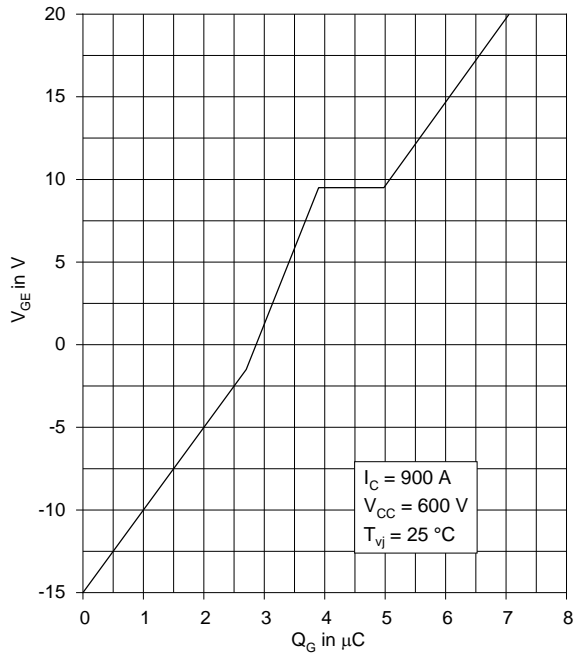

Fig. 9 Typical gate charge characteristics

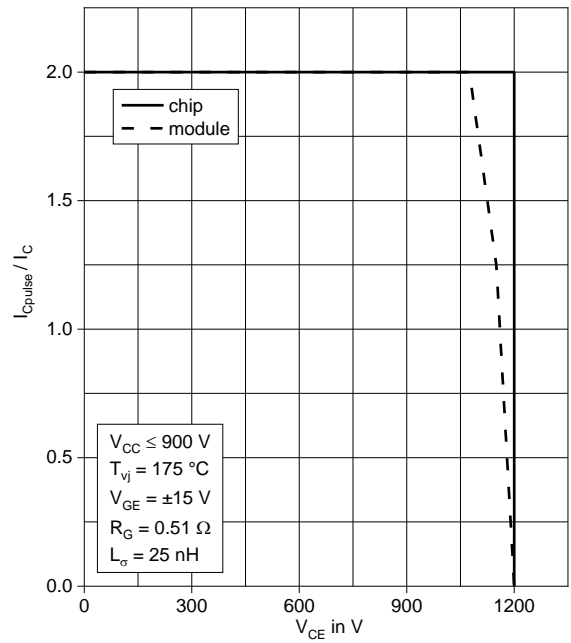

Fig. 10 Turn-off safe operating area (RBSOA)

Hitachi Energy Switzerland Ltd
 Semiconductors
 Fabrikstrasse 3
 5600 Lenzburg
 Switzerland
 Tel: +41 58 586 10 00

E-Mail: salesdesksem@hitachienergy.com

www.hitachienergy.com/semiconductors

We reserve the right to make technical changes or modify the contents of this document without prior notice. With regard to purchase orders, the agreed particulars shall prevail.

Hitachi Energy Ltd. does not accept any responsibility whatsoever for potential errors or possible lack of information in this document.

We reserve all rights in this document and in the subject matter and illustrations contained therein. Any reproduction, disclosure to third parties or utilization of its contents – in whole or in parts – is forbidden without prior written consent of Hitachi Energy Ltd.

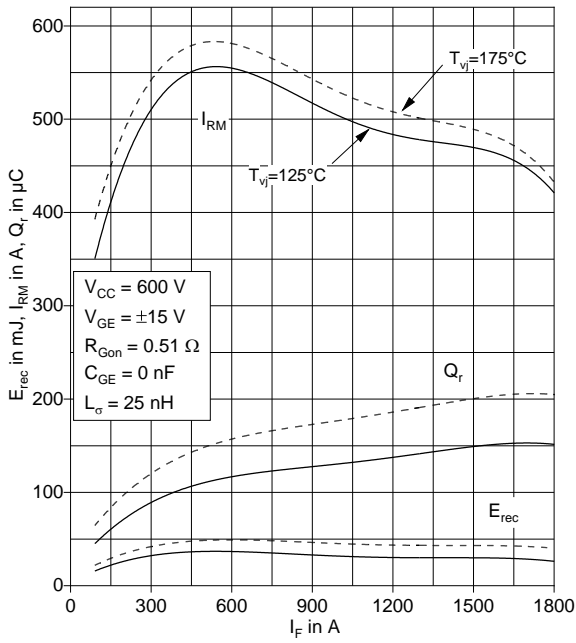

Fig. 11 Typical reverse recovery characteristics vs. forward current

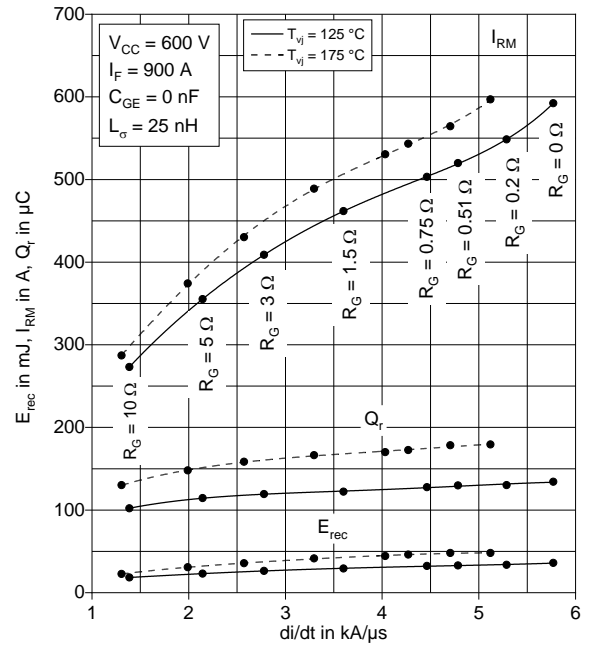

Fig. 12 Typical reverse recovery characteristics vs. di/dt

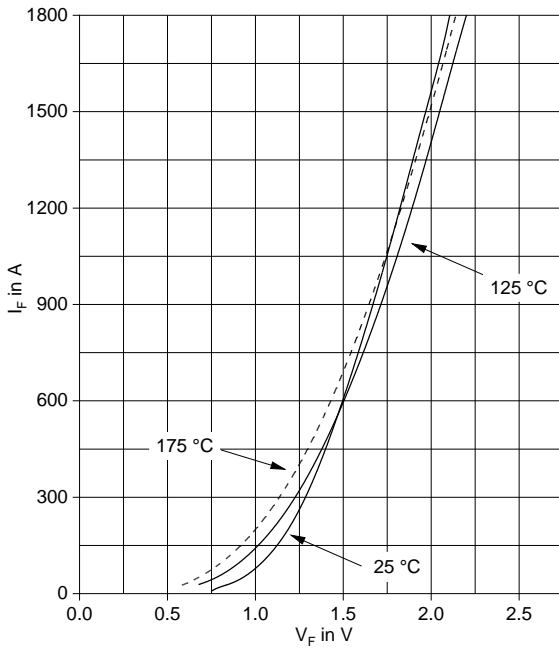

Fig. 13 Typical diode forward characteristics chip level

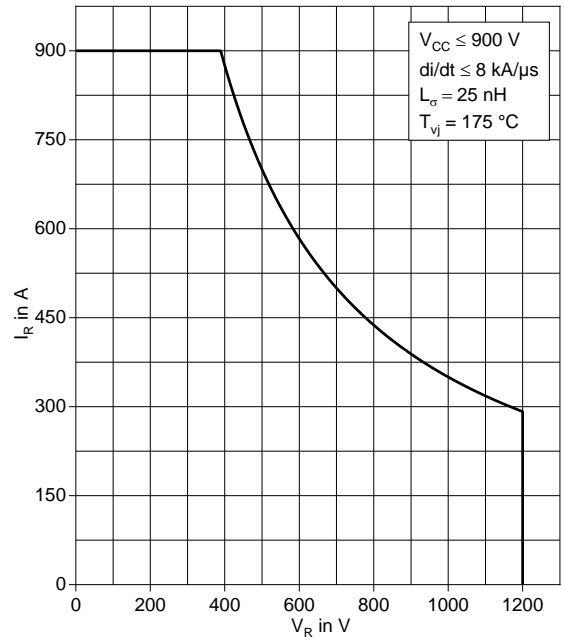

Fig. 14 Diode turn-off safe operating area (DSOA)

Hitachi Energy Switzerland Ltd
Semiconductors
Fabrikstrasse 3
5600 Lenzburg
Switzerland
Tel: +41 58 586 10 00

E-Mail: salesdesksem@hitachienergy.com

We reserve the right to make technical changes or modify the contents of this document without prior notice. With regard to purchase orders, the agreed particulars shall prevail.

Hitachi Energy Ltd. does not accept any responsibility whatsoever for potential errors or possible lack of information in this document.

We reserve all rights in this document and in the subject matter and illustrations contained therein. Any reproduction, disclosure to third parties or utilization of its contents – in whole or in parts – is forbidden without prior written consent of Hitachi Energy Ltd.

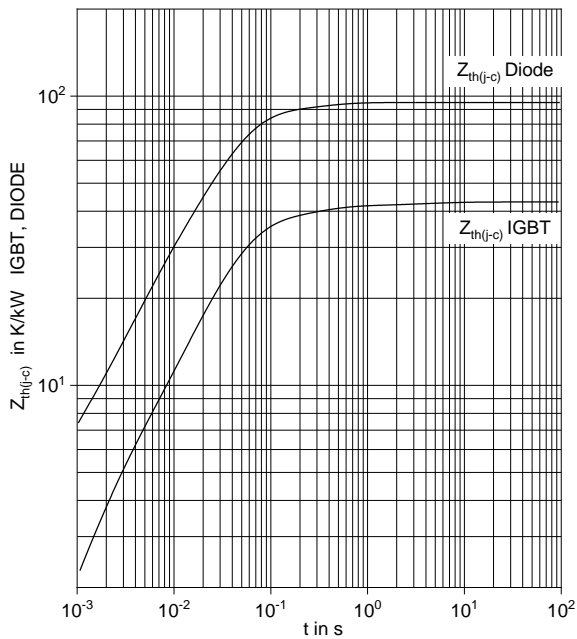

Fig. 15 Thermal impedance vs time

Analytical function for transient thermal impedance:

$$Z_{th(j-c)}(t) = \sum_{i=1}^n R_i (1 - e^{-t/\tau_i})$$

	i	1	2	3	4	5
IGBT	R _i (K/kW)	3.05	6.65	31.8	1.53	
	τ _i (ms)	1.92	229.4	35.1	3923	
DIODE	R _i (K/kW)	3.52	9.96	72	9.53	
	τ _i (ms)	0.4	263.8	35.4	4.4	

Related documents:

- 5SYA 2042 Failure rates of IGBT modules due to cosmic rays
- 5SYA 2045 Thermal runaway during blocking
- 5SYA 2053 Applying IGBT
- 5SYA 2057 IGBT diode safe operating area (SOA)

- 5SYA 2058 Surge currents for IGBT diodes
- 5SYA 2093 Thermal design of IGBT modules
- 5SYA 2098 Paralleling of IGBT modules
- 5SYA 2142 LoPak modules use and installation

Hitachi Energy Switzerland Ltd
Semiconductors
Fabrikstrasse 3
5600 Lenzburg
Switzerland
Tel: +41 58 586 10 00

E-Mail: salesdesksem@hitachienergy.com

We reserve the right to make technical changes or modify the contents of this document without prior notice. With regard to purchase orders, the agreed particulars shall prevail.

Hitachi Energy Ltd. does not accept any responsibility whatsoever for potential errors or possible lack of information in this document.

We reserve all rights in this document and in the subject matter and illustrations contained therein. Any reproduction, disclosure to third parties or utilization of its contents – in whole or in parts – is forbidden without prior written consent of Hitachi Energy Ltd.