

5SNE 1000E330300

HiPak Chopper IGBT Module

$$V_{CE} = 3300 \text{ V}$$

$$I_C = 1000 \text{ A}$$

Ultra low-loss, rugged SPT+ chip-set
 Smooth switching SPT+ chip-set for good EMC
 AISiC base-plate for high power cycling capability
 AlN substrate for low thermal resistance
 Improved high reliability package
 Recognized under UL1557, File E196689

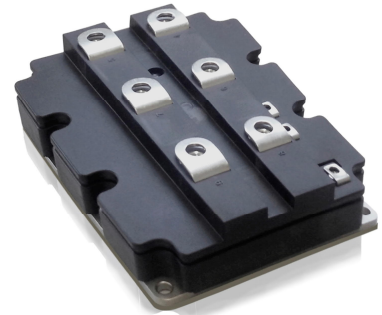

Maximum rated values ¹⁾

Parameter	Symbol	Conditions	min	max	Unit
Collector-emitter voltage	V_{CES}	$V_{GE} = 0 \text{ V}, T_{vj} \geq 25 \text{ }^\circ\text{C}$		3300	V
DC collector current	I_C	$T_C = 100 \text{ }^\circ\text{C}, T_{vj} = 150 \text{ }^\circ\text{C}$		1000	A
Peak collector current	I_{CM}	$t_p = 1 \text{ ms}$		2000	A
Gate-emitter voltage	V_{GES}		-20	20	V
Total power dissipation	P_{tot}	$T_C = 25 \text{ }^\circ\text{C}, T_{vj} = 150 \text{ }^\circ\text{C}, \text{ per switch}$		9800	W
DC forward current	I_F			1000	A
Peak forward current	I_{FRM}	$t_p = 1 \text{ ms}$		2000	A
Surge current	I_{FSM}	$V_R = 0 \text{ V}, T_{vj} = 150 \text{ }^\circ\text{C},$ $t_p = 10 \text{ ms}, \text{ half-sinewave}$		9000	A
IGBT short circuit SOA	t_{psc}	$V_{CC} = 2500 \text{ V}, V_{CEM \text{ CHIP}} \leq 3300 \text{ V}$ $V_{GE} \leq 15 \text{ V}, T_{vj} \leq 150 \text{ }^\circ\text{C}$		10	μs
Isolation voltage	V_{ISOL}	1 min, $f = 50 \text{ Hz}$		6000	V
Junction temperature	T_{vj}			175	$^\circ\text{C}$
Junction operating temperature	$T_{vj(op)}$		-50	150	$^\circ\text{C}$
Case temperature	T_C		-50	150	$^\circ\text{C}$
Storage temperature	T_{stg}		-50	125	$^\circ\text{C}$
Mounting torques ²⁾	M_s	Base-heatsink, M6 screws	4	6	Nm
	M_{t1}	Main terminals, M8 screws	8	10	
	M_{t2}	Auxiliary terminals, M4 screws	2	3	

¹⁾ Maximum rated values indicate limits beyond which damage to the device may occur per IEC 60747

²⁾ for detailed mounting instructions refer to Document No. 5SYA 2039

IGBT characteristic values ³⁾

Parameter	Symbol	Conditions	min	typ	max	Unit
Collector (-emitter) breakdown voltage	$V_{(BR)CES}$	$V_{GE} = 0 \text{ V}$, $I_C = 10 \text{ mA}$, $T_{vj} = 25 \text{ °C}$	3300			V
Collector-emitter ⁴⁾ saturation voltage	$V_{CE \text{ sat}}$	$I_C = 1000 \text{ A}$, $V_{GE} = 15 \text{ V}$	$T_{vj} = 25 \text{ °C}$	2.5	2.9	V
			$T_{vj} = 125 \text{ °C}$	3.1	3.4	V
			$T_{vj} = 150 \text{ °C}$	3.25		V
Collector cut-off current	I_{CES}	$V_{CE} = 3300 \text{ V}$, $V_{GE} = 0 \text{ V}$	$T_{vj} = 25 \text{ °C}$	0.04	0.67	mA
			$T_{vj} = 125 \text{ °C}$	13.5	27	mA
			$T_{vj} = 150 \text{ °C}$	67		mA
Gate leakage current	I_{GES}	$V_{CE} = 0 \text{ V}$, $V_{GE} = \pm 20 \text{ V}$, $T_{vj} = 125 \text{ °C}$	-500		500	nA
Gate-emitter threshold voltage	$V_{GE(th)}$	$I_C = 160 \text{ mA}$, $V_{CE} = V_{GE}$, $T_{vj} = 25 \text{ °C}$	5		7	V
Gate charge	Q_G	$I_C = 1000 \text{ A}$, $V_{CE} = 1800 \text{ V}$, $V_{GE} = -15 \text{ V} \dots 15 \text{ V}$		7.33		μC
Input capacitance	C_{ies}	$V_{CE} = 25 \text{ V}$, $V_{GE} = 0 \text{ V}$, $f = 1 \text{ MHz}$, $T_{vj} = 25 \text{ °C}$		101		nF
Output capacitance	C_{oes}			8.4		nF
Reverse transfer capacitance	C_{res}			2.57		nF
Internal gate resistance	R_{Gint}			0.9		Ω
Turn-on delay time	$t_{d(on)}$	$V_{CC} = 1800 \text{ V}$, $I_C = 1000 \text{ A}$, $R_G = 1.5 \text{ }\Omega$, $C_{GE} = 220 \text{ nF}$, $V_{GE} = \pm 15 \text{ V}$, $L_\sigma = 100 \text{ nH}$, inductive load	$T_{vj} = 25 \text{ °C}$	560		ns
			$T_{vj} = 125 \text{ °C}$	530		ns
			$T_{vj} = 150 \text{ °C}$	530		ns
Rise time	t_r	$V_{CC} = 1800 \text{ V}$, $I_C = 1000 \text{ A}$, $R_G = 1.5 \text{ }\Omega$, $C_{GE} = 220 \text{ nF}$, $V_{GE} = \pm 15 \text{ V}$, $L_\sigma = 100 \text{ nH}$, inductive load	$T_{vj} = 25 \text{ °C}$	240		ns
			$T_{vj} = 125 \text{ °C}$	255		ns
			$T_{vj} = 150 \text{ °C}$	260		ns
Turn-off delay time	$t_{d(off)}$	$V_{CC} = 1800 \text{ V}$, $I_C = 1000 \text{ A}$, $R_G = 2.2 \text{ }\Omega$, $C_{GE} = 220 \text{ nF}$, $V_{GE} = \pm 15 \text{ V}$, $L_\sigma = 100 \text{ nH}$, inductive load	$T_{vj} = 25 \text{ °C}$	1465		ns
			$T_{vj} = 125 \text{ °C}$	1640		ns
			$T_{vj} = 150 \text{ °C}$	1700		ns
Fall time	t_f	$V_{CC} = 1800 \text{ V}$, $I_C = 1000 \text{ A}$, $R_G = 2.2 \text{ }\Omega$, $C_{GE} = 220 \text{ nF}$, $V_{GE} = \pm 15 \text{ V}$, $L_\sigma = 100 \text{ nH}$, inductive load	$T_{vj} = 25 \text{ °C}$	315		ns
			$T_{vj} = 125 \text{ °C}$	385		ns
			$T_{vj} = 150 \text{ °C}$	400		ns
Turn-on switching energy	E_{on}	$V_{CC} = 1800 \text{ V}$, $I_C = 1000 \text{ A}$, $R_G = 1.5 \text{ }\Omega$, $C_{GE} = 220 \text{ nF}$, $V_{GE} = \pm 15 \text{ V}$, $L_\sigma = 100 \text{ nH}$, inductive load	$T_{vj} = 25 \text{ °C}$	1250		mJ
			$T_{vj} = 125 \text{ °C}$	1640		mJ
			$T_{vj} = 150 \text{ °C}$	1800		mJ
Turn-off switching energy	E_{off}	$V_{CC} = 1800 \text{ V}$, $I_C = 1000 \text{ A}$, $R_G = 2.2 \text{ }\Omega$, $C_{GE} = 220 \text{ nF}$, $V_{GE} = \pm 15 \text{ V}$, $L_\sigma = 100 \text{ nH}$, inductive load	$T_{vj} = 25 \text{ °C}$	1240		mJ
			$T_{vj} = 125 \text{ °C}$	1730		mJ
			$T_{vj} = 150 \text{ °C}$	1870		mJ
Short circuit current	I_{SC}	$t_{psc} \leq 10 \text{ }\mu\text{s}$, $V_{GE} = 15 \text{ V}$, $V_{CC} = 2500 \text{ V}$, $V_{CEM \text{ CHIP}} \leq 3300 \text{ V}$	$T_{vj} = 150 \text{ °C}$	4270		A

³⁾ Characteristic values according to IEC 60747 - 9

⁴⁾ Collector-emitter saturation voltage is given at chip level

Diode characteristic values ⁵⁾

Parameter	Symbol	Conditions	min	typ	max	Unit	
Forward voltage ⁶⁾	V_F	$I_F = 1000 \text{ A}$	$T_{vj} = 25 \text{ }^\circ\text{C}$	2.05	2.5	V	
			$T_{vj} = 125 \text{ }^\circ\text{C}$		2.25	2.6	V
			$T_{vj} = 150 \text{ }^\circ\text{C}$		2.20		V
Peak reverse recovery current	I_{RM}		$T_{vj} = 25 \text{ }^\circ\text{C}$	1010		A	
			$T_{vj} = 125 \text{ }^\circ\text{C}$		1180		A
			$T_{vj} = 150 \text{ }^\circ\text{C}$		1230		A
Recovered charge	Q_r	$V_{CC} = 1800 \text{ V}$, $I_F = 1000 \text{ A}$, $V_{GE} = \pm 15 \text{ V}$, $R_G = 1.5 \text{ } \Omega$, $C_{GE} = 220 \text{ nF}$, $di/dt = 4 \text{ kA}/\mu\text{s}$ $L_\sigma = 100 \text{ nH}$, inductive load	$T_{vj} = 25 \text{ }^\circ\text{C}$	630		μC	
			$T_{vj} = 125 \text{ }^\circ\text{C}$		1020		μC
			$T_{vj} = 150 \text{ }^\circ\text{C}$		1180		μC
Reverse recovery time	t_{rr}		$T_{vj} = 25 \text{ }^\circ\text{C}$	1125		ns	
			$T_{vj} = 125 \text{ }^\circ\text{C}$		1440		ns
			$T_{vj} = 150 \text{ }^\circ\text{C}$		1630		ns
Reverse recovery energy	E_{rec}		$T_{vj} = 25 \text{ }^\circ\text{C}$	700		mJ	
			$T_{vj} = 125 \text{ }^\circ\text{C}$		1210		mJ
			$T_{vj} = 150 \text{ }^\circ\text{C}$		1420		mJ

⁵⁾ Characteristic values according to IEC 60747 - 2

⁶⁾ Forward voltage is given at chip level

Package properties ⁷⁾

Parameter	Symbol	Conditions	min	typ	max	Unit
IGBT thermal resistance junction to case	$R_{th(j-c)IGBT}$	per switch			0.013	K/W
Diode thermal resistance junction to case	$R_{th(j-c)DIODE}$				0.025	K/W
IGBT thermal resistance ²⁾ case to heatsink	$R_{th(c-s)IGBT}$	IGBT per switch, λ grease = $1\text{W}/\text{m} \times \text{K}$		0.012		K/W
Diode thermal resistance ²⁾ case to heatsink	$R_{th(c-s)DIODE}$	Diode per switch, λ grease = $1\text{W}/\text{m} \times \text{K}$		0.024		K/W
Partial discharge extinction voltage	V_e	$f = 50 \text{ Hz}$, $Q_{PD} \leq 10 \text{ pC}$ (acc. To IEC 61287)	3500			V
Comparative tracking index	CTI		600			
Module stray inductance	$L_{\sigma CE}$	per switch		12		nH
Resistance, terminal-chip	$R_{CC'+EE'}$	per switch	$T_C = 25 \text{ }^\circ\text{C}$	0.083		m Ω
			$T_C = 125 \text{ }^\circ\text{C}$	0.113		
			$T_C = 150 \text{ }^\circ\text{C}$	0.120		

²⁾ For detailed mounting instructions refer to Document No. 5SYA 2039

Mechanical properties ⁷⁾

Parameter	Symbol	Conditions	min	typ	max	Unit
Dimensions	L x W x H	Typical		190 x 140 x 38		mm
Clearance distance in air	d_a	according to IEC 60664-1 and EN 50124-1	Term. to base:	19		mm
			Term. to term:	19		
Surface creepage distance	d_s	according to IEC 60664-1 and EN 50124-1	Term. to base:	28.2		mm
			Term. to term:	28.2		
Mass	m			1210		g

⁷⁾ Package and mechanical properties according to IEC 60747 - 15

Electrical configuration

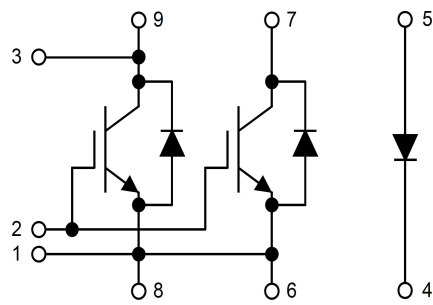

Outline drawing ²⁾

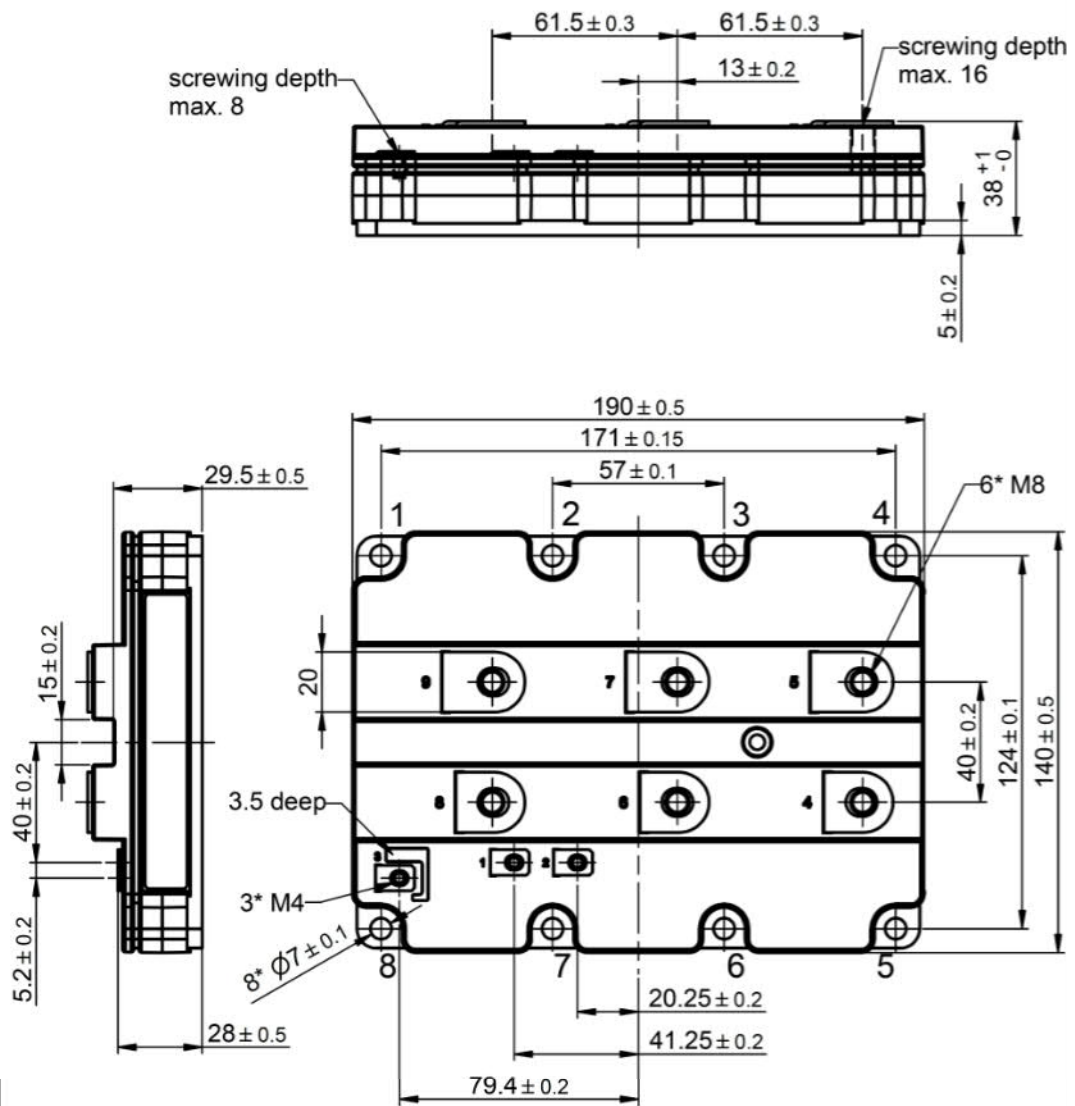

Note: all dimensions are shown in millimeters
²⁾ For detailed mounting instructions refer to Document No. 5SYA 2039

This is an electrostatic sensitive device, please observe the international standard IEC 60747-1, chap. VIII.
 This product has been designed and qualified for Industrial Level.

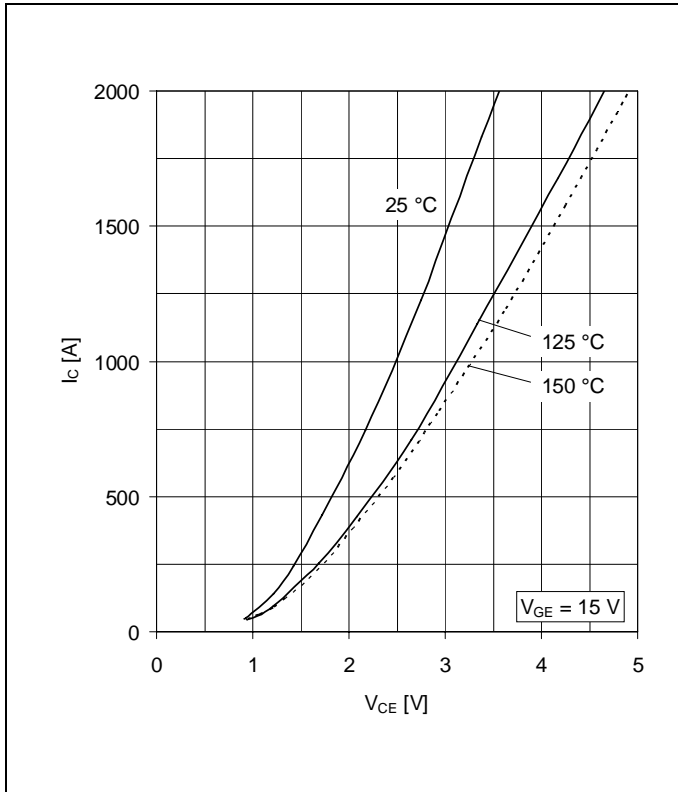

Fig. 1 Typical on-state characteristics, chip level

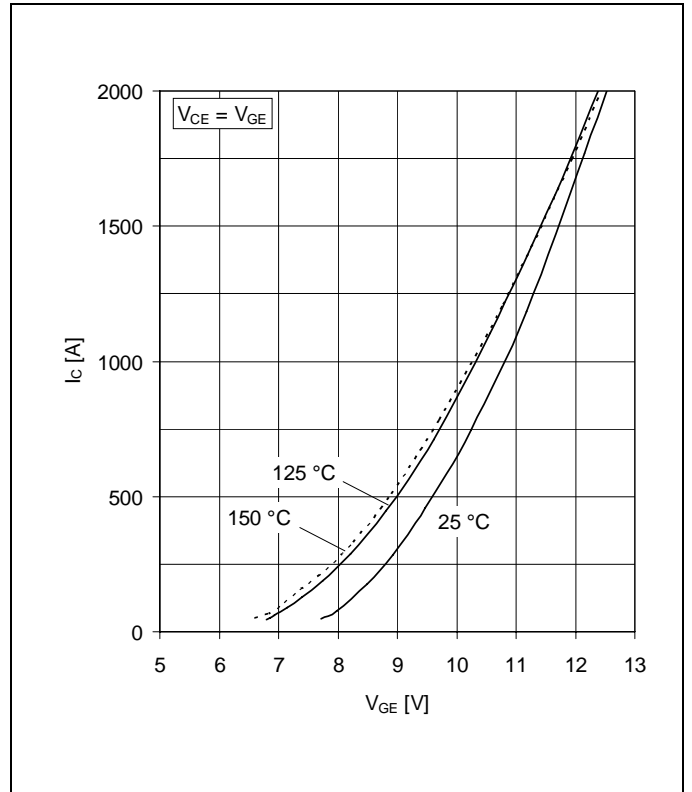

Fig. 2 Typical transfer characteristics, chip level

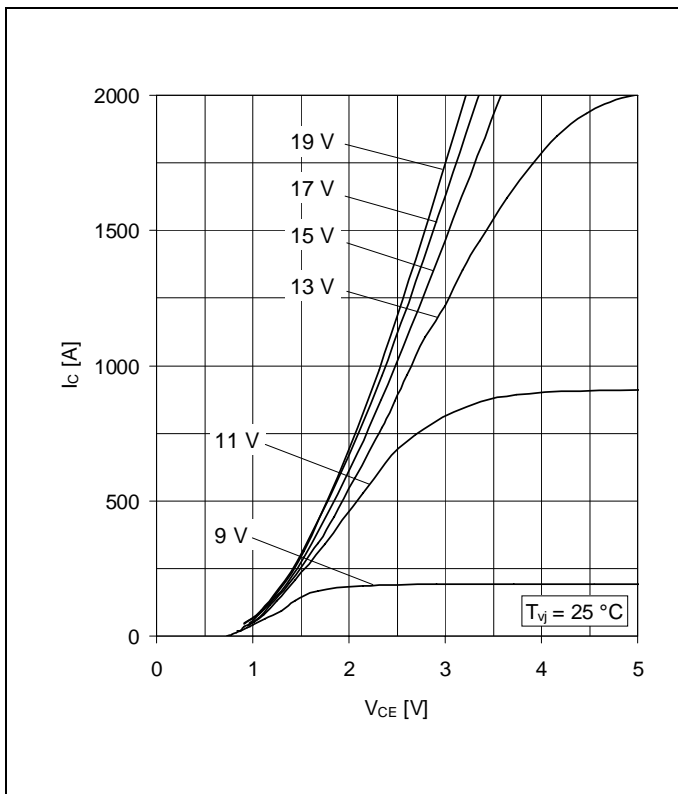

Fig. 3 Typical output characteristics, chip level

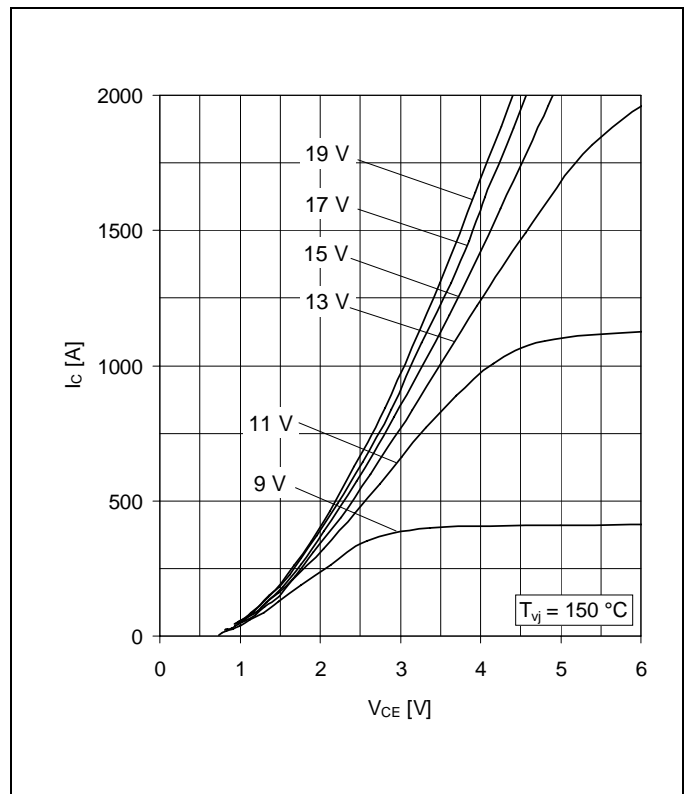

Fig. 4 Typical output characteristics, chip level

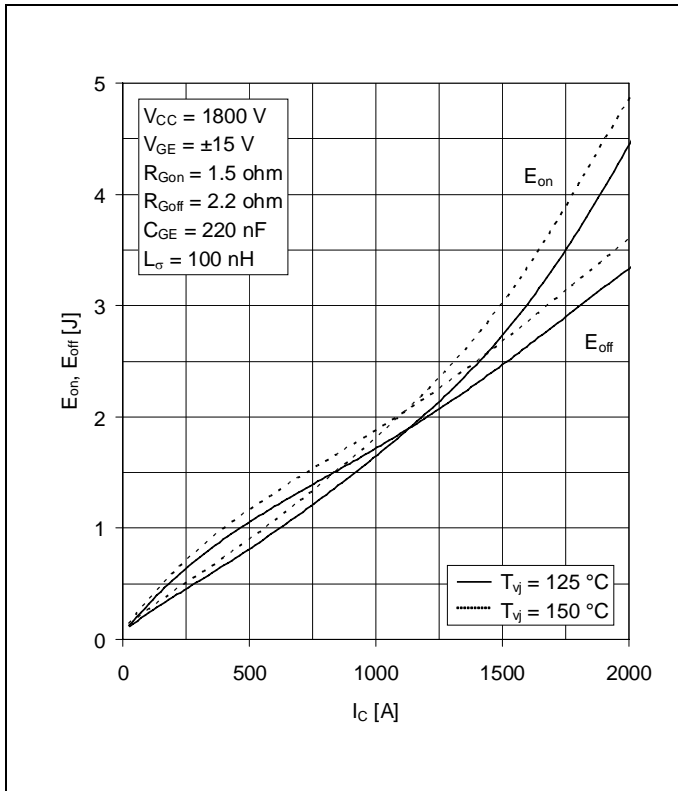

Fig. 5 Typical switching energies per pulse vs. collector current

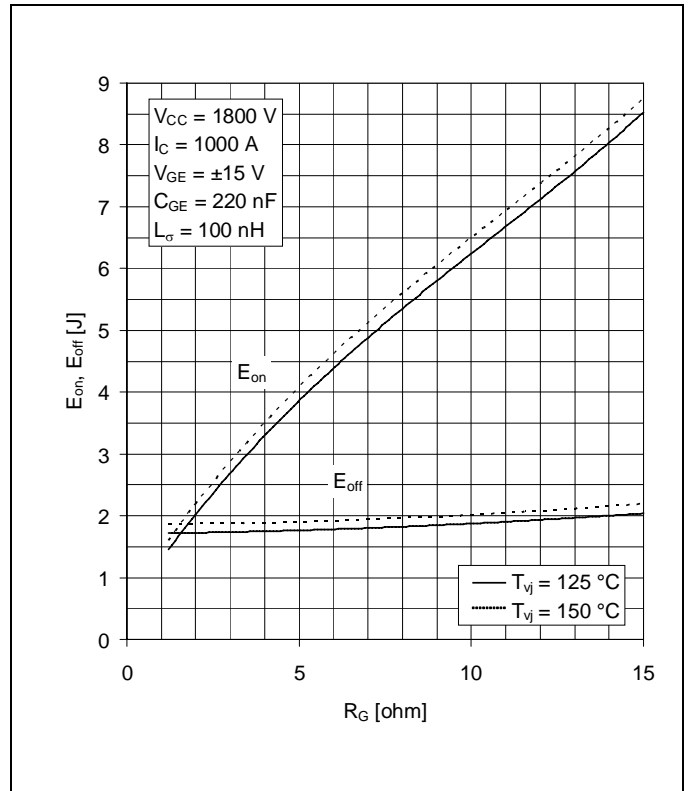

Fig. 6 Typical switching energies per pulse vs. gate resistor

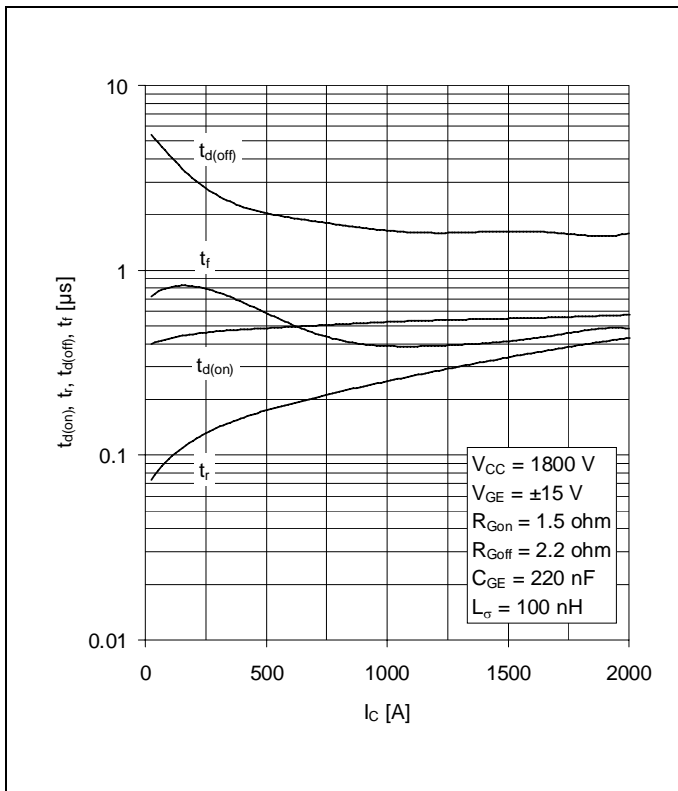

Fig. 7 Typical switching times vs. collector current

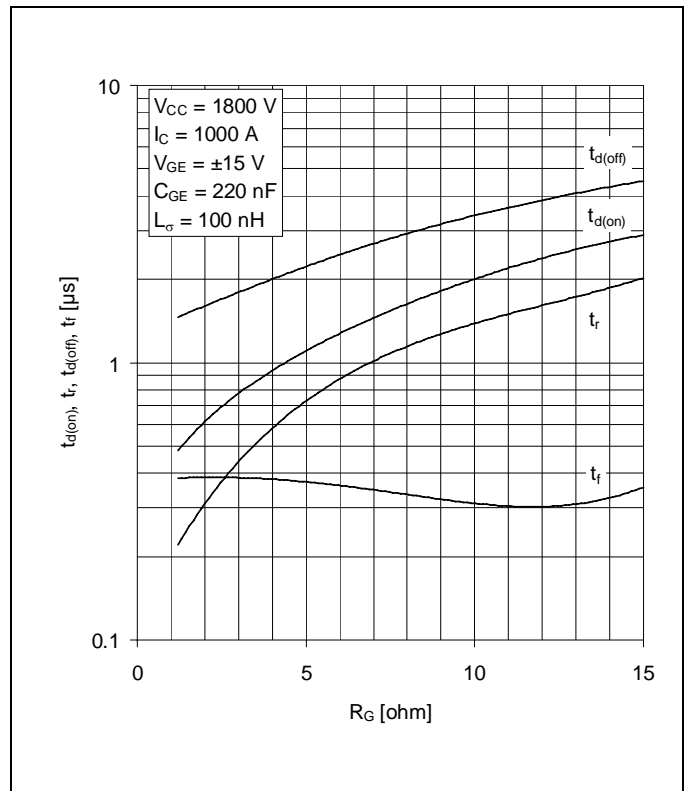

Fig. 8 Typical switching times vs. gate resistor

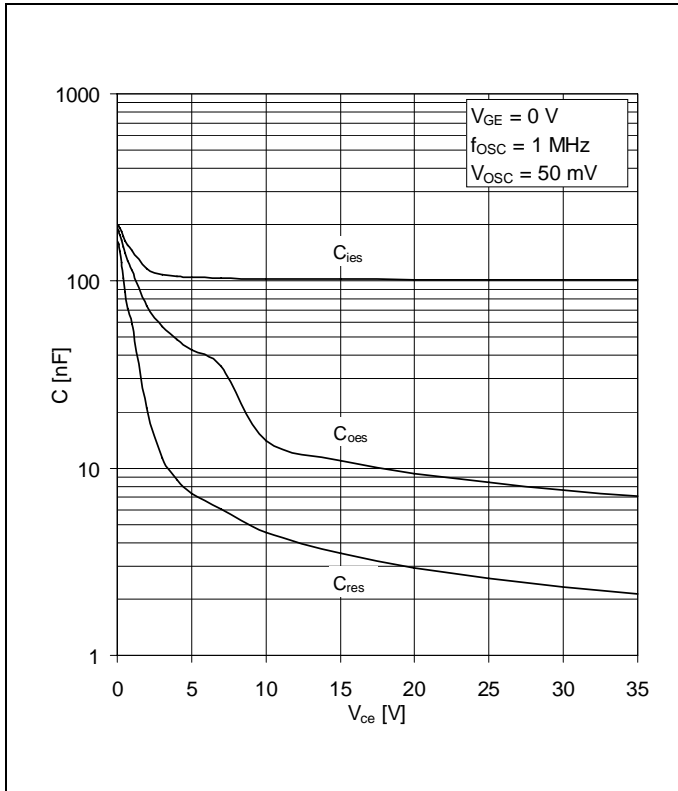

Fig. 9 Typical capacitances vs. collector-emitter voltage

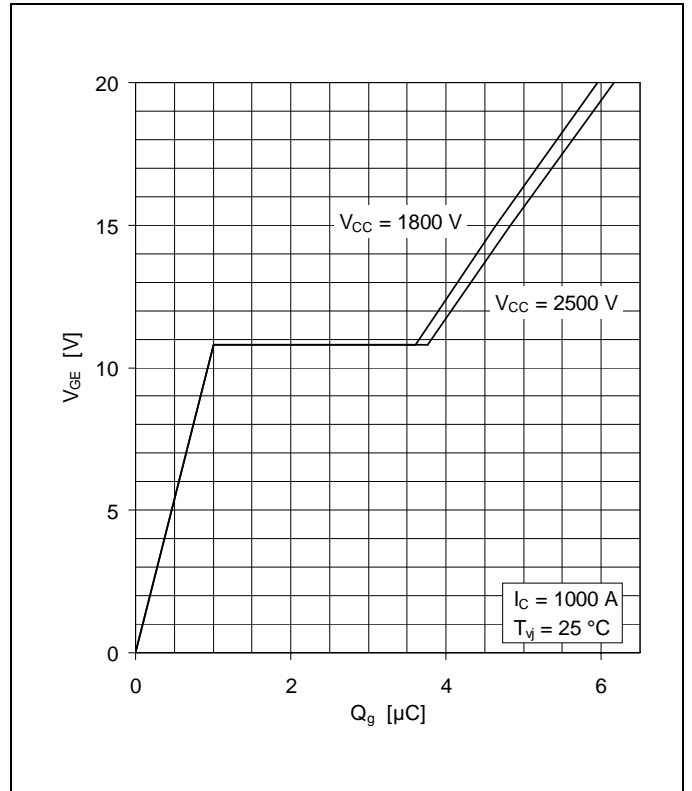

Fig. 10 Typical gate charge characteristics

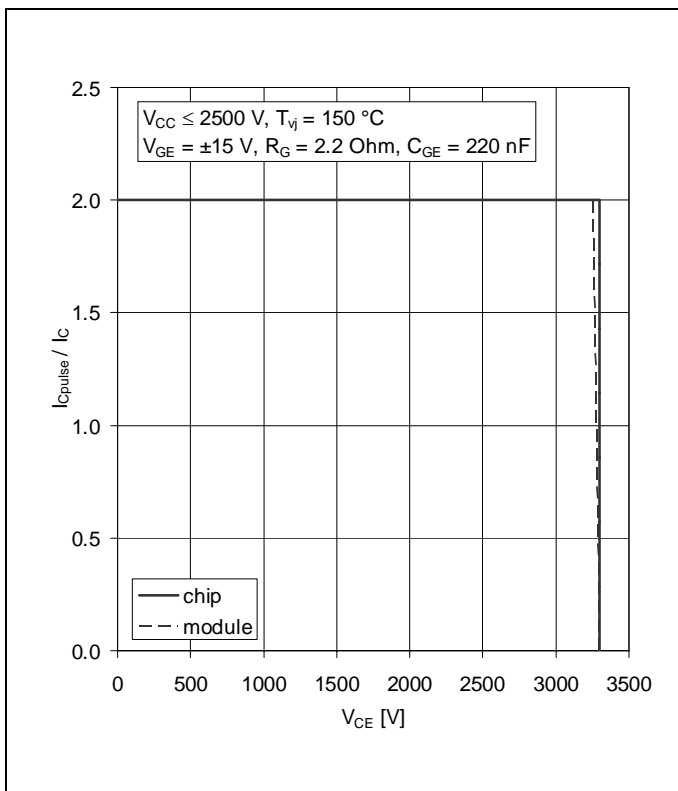

Fig. 11 Turn-off safe operating area (RBSOA)

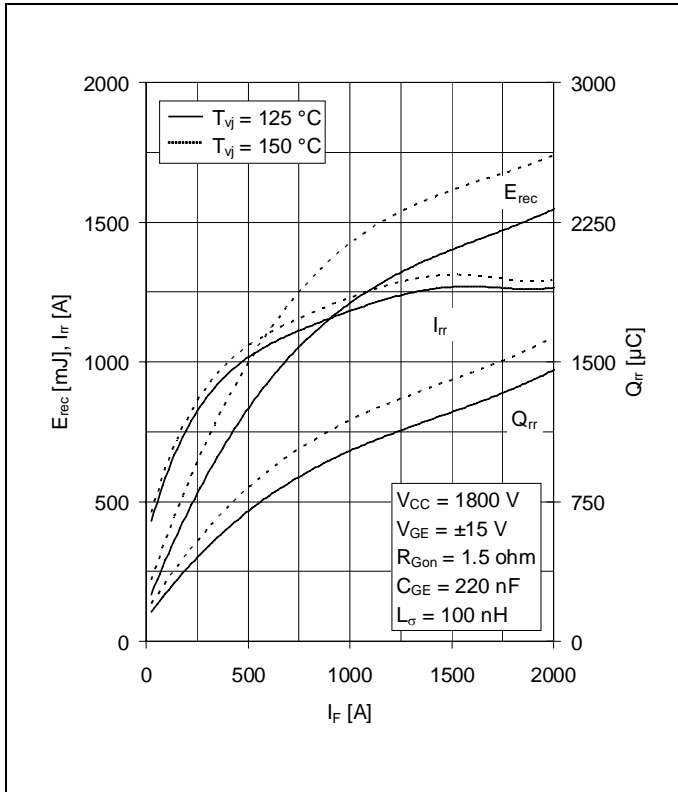

Fig. 12 Typical reverse recovery characteristics vs. forward current

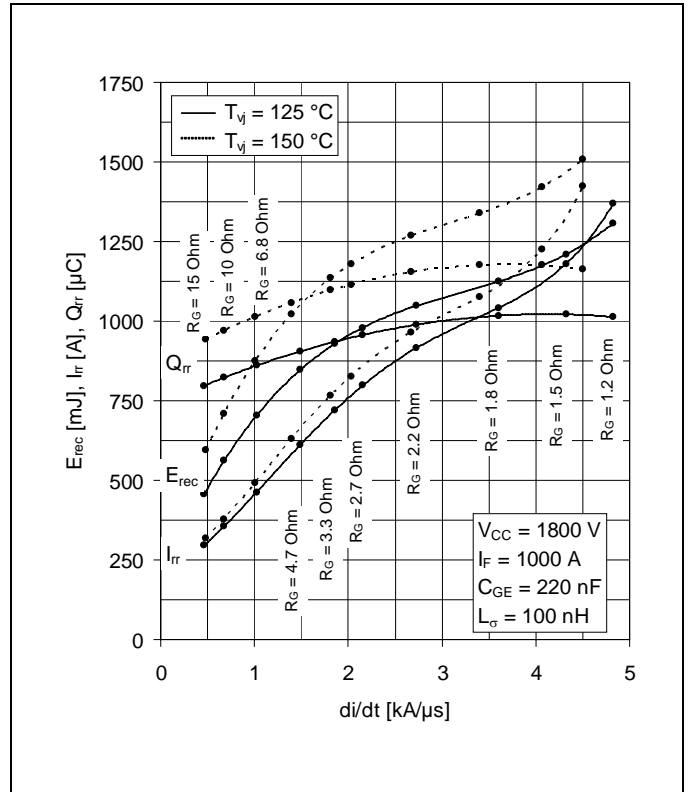

Fig. 13 Typical reverse recovery characteristics vs. di/dt

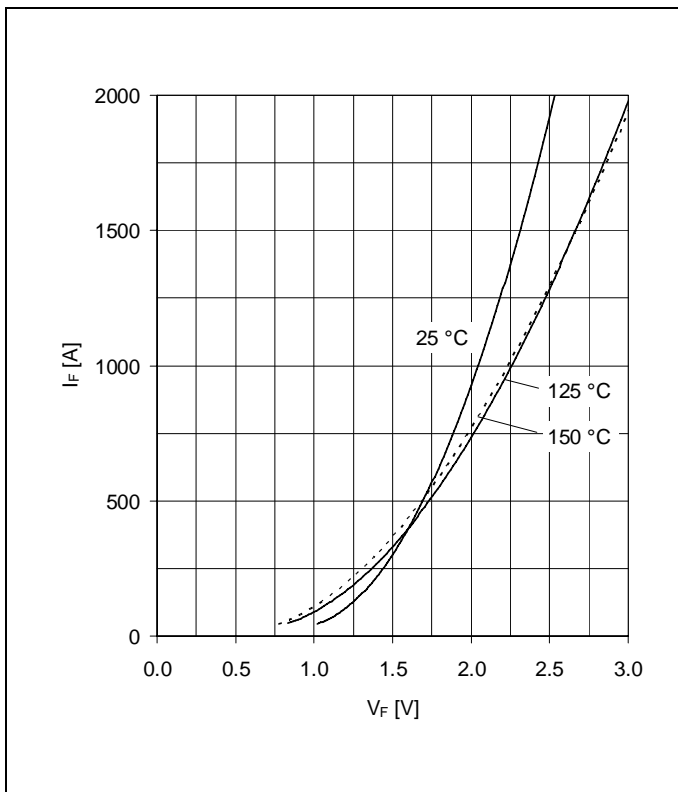

Fig. 14 Typical diode forward characteristics chip level

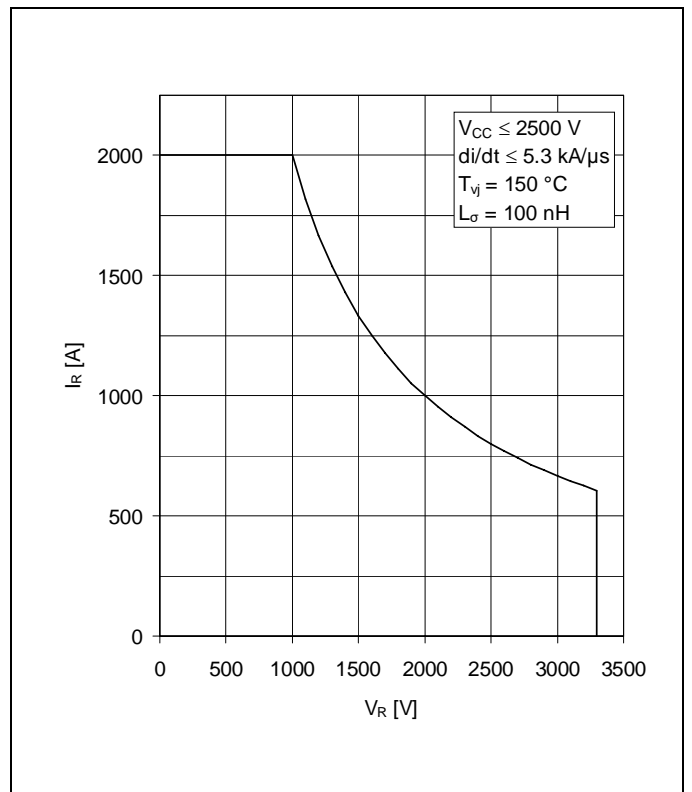

Fig. 15 Safe operating area diode (SOA)

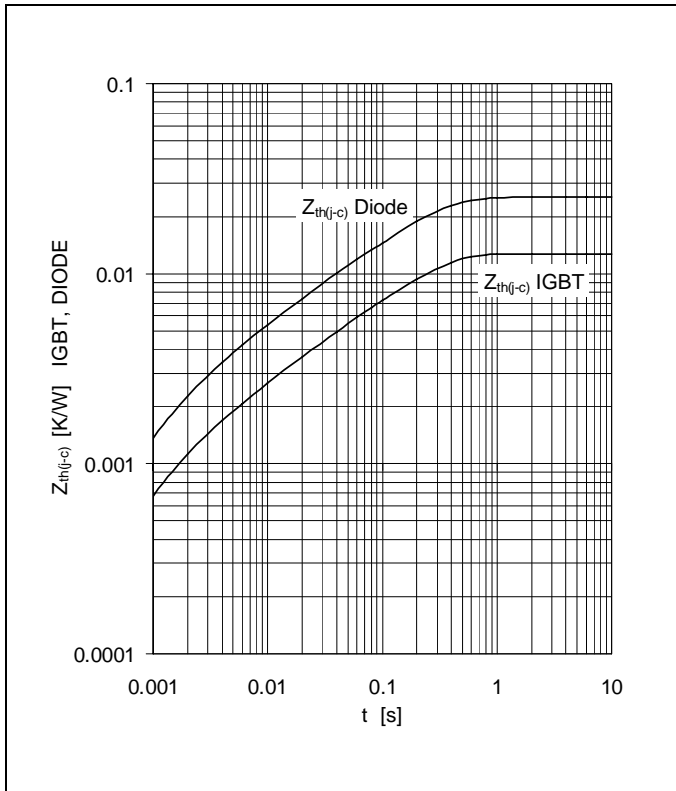

Fig. 16 Thermal impedance vs. time

Analytical function for transient thermal impedance:

$$Z_{th(j-c)}(t) = \sum_{i=1}^n R_i (1 - e^{-t/\tau_i})$$

	i	1	2	3	4	5
IGBT	$R_i(K/kW)$	8.78	2.06	0.961	0.948	
	$\tau_i(ms)$	207.4	30.1	7.55	1.57	
DIODE	$R_i(K/kW)$	17.1	4.28	1.92	1.92	
	$\tau_i(ms)$	203.6	30.1	7.53	1.57	

Related documents:

- 5SYA 2042 Failure rates of HiPak modules due to cosmic rays
- 5SYA 2043 Load - cycle capability of HiPaks
- 5SYA 2045 Thermal runaway during blocking
- 5SYA 2053 Applying IGBT
- 5SYA 2058 Surge currents for IGBT diodes
- 5SYA 2093 Thermal design and temperature ratings of IGBT modules
- 5SYA 2098 Paralleling of IGBT modules
- 5SZK 9111 Specification of environmental class for HiPak Storage
- 5SZK 9112 Specification of environmental class for HiPak Transportation
- 5SZK 9113 Specification of environmental class for HiPak Operation (Industry)
- 5SZK 9120 Specification of environmental class for HiPak

ABB Power Grids Switzerland Ltd, Semiconductors
 A Hitachi ABB Joint Venture
 Fabrikstrasse 3
 CH-5600 Lenzburg
 Switzerland
www.hitachiabb-powergrids.com/semiconductors

We reserve all rights in this document and in the subject matter and illustrations contained therein. Any reproduction, disclosure to third parties or utilization of its contents - in whole or in parts - is forbidden without prior written consent. Copyright 2020 Hitachi Powergrids. All rights reserved.