

5SNA 2400N170300

HiPak IGBT Module

$$V_{CE} = 1700 \text{ V}$$

$$I_C = 2400 \text{ A}$$

Ultra low-loss, rugged SPT+ chip-set
 Smooth switching SPT+ chip-set for good EMC
 AISiC base-plate for high power cycling capability
 AlN substrate for low thermal resistance
 Improved high reliability package
 Recognized under UL1557, File E196689



Maximum rated values ¹⁾

Parameter	Symbol	Conditions	min	max	Unit
Collector-emitter voltage	V_{CES}	$V_{GE} = 0 \text{ V}$, $T_{vj} \geq 25 \text{ }^\circ\text{C}$		1700	V
DC collector current	I_C	$T_C = 70 \text{ }^\circ\text{C}$, $T_{vj} = 150 \text{ }^\circ\text{C}$		2400	A
Peak collector current	I_{CM}	$t_p = 1 \text{ ms}$		4800	A
Gate-emitter voltage	V_{GES}		-20	20	V
Total power dissipation	P_{tot}	$T_C = 25 \text{ }^\circ\text{C}$, $T_{vj} = 150 \text{ }^\circ\text{C}$		11900	W
DC forward current	I_F			2400	A
Peak forward current	I_{FRM}	$t_p = 1 \text{ ms}$		4800	A
Surge current	I_{FSM}	$V_R = 0 \text{ V}$, $T_{vj} = 150 \text{ }^\circ\text{C}$, $t_p = 10 \text{ ms}$, half-sinewave		12000	A
IGBT short circuit SOA	t_{psc}	$V_{CC} = 1200 \text{ V}$, $V_{CEM \text{ CHIP}} \leq 1700 \text{ V}$ $V_{GE} \leq 15 \text{ V}$, $T_{vj \text{ start}} \leq 150 \text{ }^\circ\text{C}$		10	μs
Isolation voltage	V_{ISOL}	1 min, $f = 50 \text{ Hz}$		4000	V
Junction temperature	T_{vj}			175	$^\circ\text{C}$
Junction operating temperature	$T_{vj(op)}$		-50	150	$^\circ\text{C}$
Case temperature	T_C		-50	150	$^\circ\text{C}$
Storage temperature	T_{stg}		-50	125	$^\circ\text{C}$
Mounting torques ²⁾	M_s	Base-heatsink, M6 screws	4	6	Nm
	M_{t1}	Main terminals, M8 screws	8	10	
	M_{t2}	Auxiliary terminals, M4 screws	2	3	

¹⁾ Maximum rated values indicate limits beyond which damage to the device may occur per IEC 60747

²⁾ For detailed mounting instructions refer to Document No. 5SYA 2039

IGBT characteristic values ³⁾

Parameter	Symbol	Conditions	min	typ	max	Unit	
Collector (-emitter) breakdown voltage	$V_{(BR)CES}$	$V_{GE} = 0 \text{ V}$, $I_C = 10 \text{ mA}$, $T_{vj} = 25 \text{ °C}$	1700			V	
Collector-emitter ⁴⁾ saturation voltage	$V_{CE \text{ sat}}$	$I_C = 2400 \text{ A}$, $V_{GE} = 15 \text{ V}$	$T_{vj} = 25 \text{ °C}$	2.2	2.5	2.8	V
			$T_{vj} = 125 \text{ °C}$	2.7	3	3.3	V
			$T_{vj} = 150 \text{ °C}$		3.1		V
Collector cut-off current	I_{CES}	$V_{CE} = 1700 \text{ V}$, $V_{GE} = 0 \text{ V}$	$T_{vj} = 25 \text{ °C}$		0.02	1	mA
			$T_{vj} = 125 \text{ °C}$		20	40	mA
			$T_{vj} = 150 \text{ °C}$		120		mA
Gate leakage current	I_{GES}	$V_{CE} = 0 \text{ V}$, $V_{GE} = \pm 20 \text{ V}$, $T_{vj} = 125 \text{ °C}$	-500		500	nA	
Gate-emitter threshold voltage	$V_{GE(TO)}$	$I_C = 160 \text{ mA}$, $V_{CE} = V_{GE}$, $T_{vj} = 25 \text{ °C}$	5.3		7.3	V	
Gate charge	Q_{ge}	$I_C = 2400 \text{ A}$, $V_{CE} = 900 \text{ V}$, $V_{GE} = -15 \text{ V} \dots 15 \text{ V}$		14		μC	
Internal gate resistance	R_{Gint}			0.8		Ω	
Turn-on delay time	$t_{d(on)}$	$V_{CC} = 900 \text{ V}$, $I_C = 2400 \text{ A}$, $R_G = 0.9 \text{ }\Omega$, $C_{GE} = 0 \text{ nF}$, $V_{GE} = \pm 15 \text{ V}$, $L_\sigma = 75 \text{ nH}$, inductive load	$T_{vj} = 25 \text{ °C}$		600		ns
			$T_{vj} = 125 \text{ °C}$		660		ns
			$T_{vj} = 150 \text{ °C}$		680		ns
Rise time	t_r	$V_{CC} = 900 \text{ V}$, $I_C = 2400 \text{ A}$, $R_G = 0.9 \text{ }\Omega$, $C_{GE} = 0 \text{ nF}$, $V_{GE} = \pm 15 \text{ V}$, $L_\sigma = 75 \text{ nH}$, inductive load	$T_{vj} = 25 \text{ °C}$		330		ns
			$T_{vj} = 125 \text{ °C}$		350		ns
			$T_{vj} = 150 \text{ °C}$		360		ns
Turn-off delay time	$t_{d(off)}$	$V_{CC} = 900 \text{ V}$, $I_C = 2400 \text{ A}$, $R_G = 0.9 \text{ }\Omega$, $C_{GE} = 0 \text{ nF}$, $V_{GE} = \pm 15 \text{ V}$, $L_\sigma = 75 \text{ nH}$, inductive load	$T_{vj} = 25 \text{ °C}$		940		ns
			$T_{vj} = 125 \text{ °C}$		1050		ns
			$T_{vj} = 150 \text{ °C}$		1080		ns
Fall time	t_f	$V_{CC} = 900 \text{ V}$, $I_C = 2400 \text{ A}$, $R_G = 0.9 \text{ }\Omega$, $C_{GE} = 0 \text{ nF}$, $V_{GE} = \pm 15 \text{ V}$, $L_\sigma = 75 \text{ nH}$, inductive load	$T_{vj} = 25 \text{ °C}$		270		ns
			$T_{vj} = 125 \text{ °C}$		300		ns
			$T_{vj} = 150 \text{ °C}$		310		ns
Turn-on switching energy	E_{on}	$V_{CC} = 900 \text{ V}$, $I_C = 2400 \text{ A}$, $R_G = 0.9 \text{ }\Omega$, $C_{GE} = 0 \text{ nF}$, $V_{GE} = \pm 15 \text{ V}$, $L_\sigma = 75 \text{ nH}$, inductive load	$T_{vj} = 25 \text{ °C}$		780		mJ
			$T_{vj} = 125 \text{ °C}$		1040		mJ
			$T_{vj} = 150 \text{ °C}$		1130		mJ
Turn-off switching energy	E_{off}	$V_{CC} = 900 \text{ V}$, $I_C = 2400 \text{ A}$, $R_G = 0.9 \text{ }\Omega$, $C_{GE} = 0 \text{ nF}$, $V_{GE} = \pm 15 \text{ V}$, $L_\sigma = 75 \text{ nH}$, inductive load	$T_{vj} = 25 \text{ °C}$		760		mJ
			$T_{vj} = 125 \text{ °C}$		940		mJ
			$T_{vj} = 150 \text{ °C}$		1020		mJ
Short circuit current	I_{SC}	$t_{psc} \leq 10 \text{ }\mu\text{s}$, $V_{GE} = 15 \text{ V}$, $V_{CE} = 1200 \text{ V}$, $V_{CEM \text{ CHIP}} \leq 1700 \text{ V}$	$T_{vj} = 150 \text{ °C}$	6600		A	

³⁾ Characteristic values according to IEC 60747 - 9

⁴⁾ Collector-emitter saturation voltage is given at chip level

Diode characteristic values ⁵⁾

Parameter	Symbol	Conditions	min	typ	max	Unit	
Forward voltage ⁶⁾	V_F	$I_F = 2400 \text{ A}$	$T_{vj} = 25 \text{ }^\circ\text{C}$	1.85	2.2	V	
			$T_{vj} = 125 \text{ }^\circ\text{C}$		1.95	2.3	V
			$T_{vj} = 150 \text{ }^\circ\text{C}$		1.9		V
Peak reverse recovery current	I_{RM}		$T_{vj} = 25 \text{ }^\circ\text{C}$	1190		A	
			$T_{vj} = 125 \text{ }^\circ\text{C}$	1390		A	
			$T_{vj} = 150 \text{ }^\circ\text{C}$	1470		A	
Recovered charge	Q_{rr}	$V_{CC} = 900 \text{ V},$ $I_F = 2400 \text{ A},$ $V_{GE} = \pm 15 \text{ V},$ $R_G = 0.9 \text{ }^\Omega, C_{GE} = 0 \text{ nF},$ $L_\sigma = 75 \text{ nH}, \text{ inductive load}$	$T_{vj} = 25 \text{ }^\circ\text{C}$	610		μC	
			$T_{vj} = 125 \text{ }^\circ\text{C}$	1000		μC	
			$T_{vj} = 150 \text{ }^\circ\text{C}$	1180		μC	
Reverse recovery time	t_{rr}		$T_{vj} = 25 \text{ }^\circ\text{C}$	1050		ns	
			$T_{vj} = 125 \text{ }^\circ\text{C}$	1430		ns	
			$T_{vj} = 150 \text{ }^\circ\text{C}$	1540		ns	
Reverse recovery energy	E_{rec}		$T_{vj} = 25 \text{ }^\circ\text{C}$	360		mJ	
			$T_{vj} = 125 \text{ }^\circ\text{C}$	610		mJ	
			$T_{vj} = 150 \text{ }^\circ\text{C}$	720		mJ	

⁵⁾ Characteristic values according to IEC 60747 - 15

⁶⁾ Forward voltage is given at chip level

Package properties ⁷⁾

Parameter	Symbol	Conditions	min	typ	max	Unit
IGBT thermal resistance junction to case	$R_{th(j-c)IGBT}$				0.011	K/W
Diode thermal resistance junction to case	$R_{th(j-c)DIODE}$				0.018	K/W
IGBT thermal resistance ²⁾ case to heatsink	$R_{th(c-s)IGBT}$	IGBT per switch, λ grease = 1W/m x K		0.012		K/W
Diode thermal resistance ²⁾ case to heatsink	$R_{th(c-s)DIODE}$	Diode per switch, λ grease = 1W/m x K		0.024		K/W
Comparative tracking index	CTI		600			
Module stray inductance	$L_{\sigma CE}$			12		nH
Resistance, terminal-chip	$R_{CC'+EE'}$		$T_C = 25 \text{ }^\circ\text{C}$	0.082		m Ω
			$T_C = 125 \text{ }^\circ\text{C}$	0.113		
			$T_C = 150 \text{ }^\circ\text{C}$	0.120		

²⁾ For detailed mounting instructions refer to Document No. 5SYA 2039

Mechanical properties ⁷⁾

Parameter	Symbol	Conditions	min	typ	max	Unit
Dimensions	L x W x H	Typical		130 x 140 x 38		mm
Clearance distance in air	d_a	according to IEC 60664-1 and EN 50124-1	Term. to base:	19		mm
			Term. to term:	19		
Surface creepage distance	d_s	according to IEC 60664-1 and EN 50124-1	Term. to base:	28.2		mm
			Term. to term:	28.2		
Mass	m			820		g

⁷⁾ Package and mechanical properties according to IEC 60747 - 15

Electrical configuration

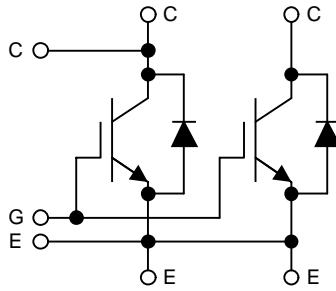

Outline drawing ²⁾

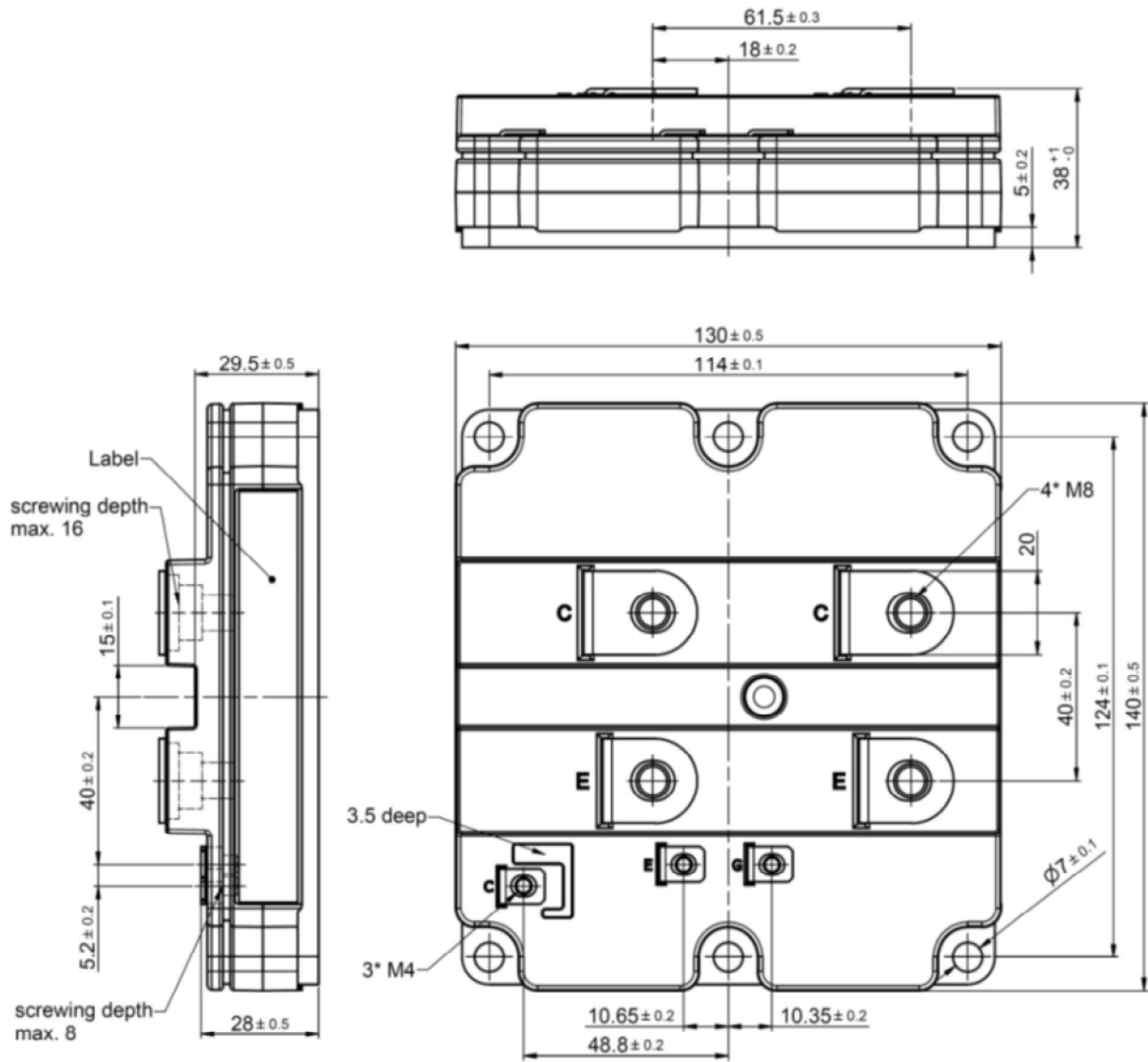

Note: all dimensions are shown in millimeters

²⁾ For detailed mounting instructions refer to Document No. 5SYA 2039

This is an electrostatic sensitive device, please observe the international standard IEC 60747-1, chap. VIII.
This product has been designed and qualified for Industrial Level.

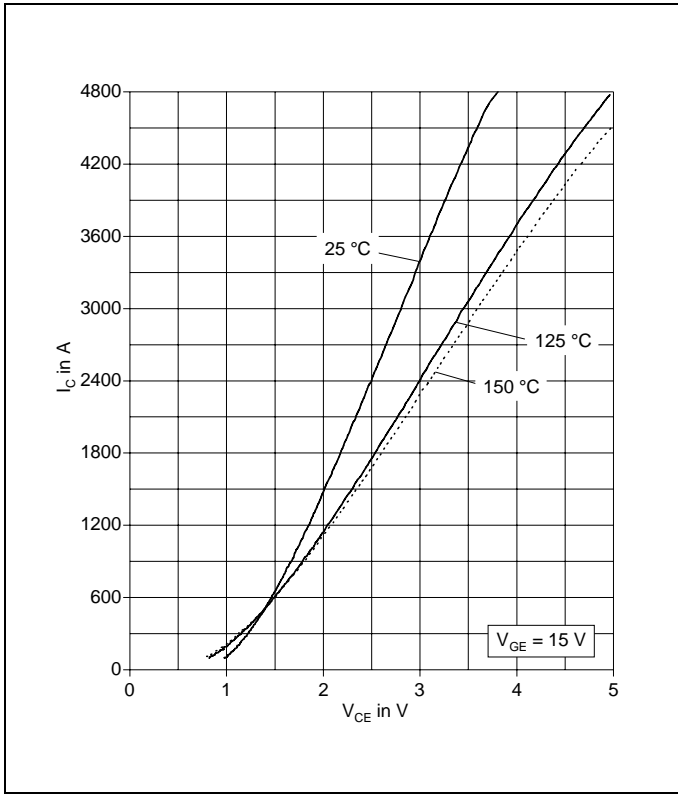

Fig. 1 Typical on-state characteristics, chip level

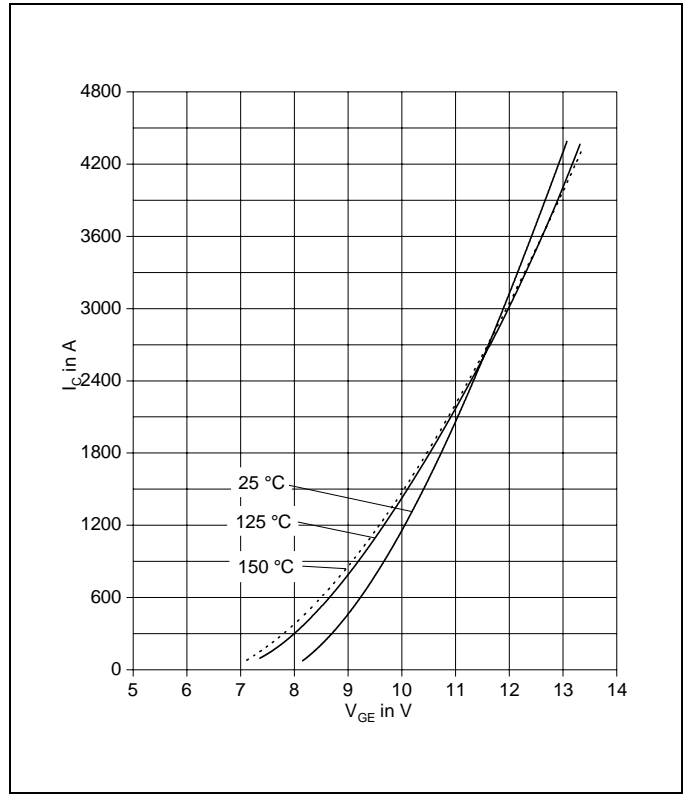

Fig. 2 Typical transfer characteristics, chip level

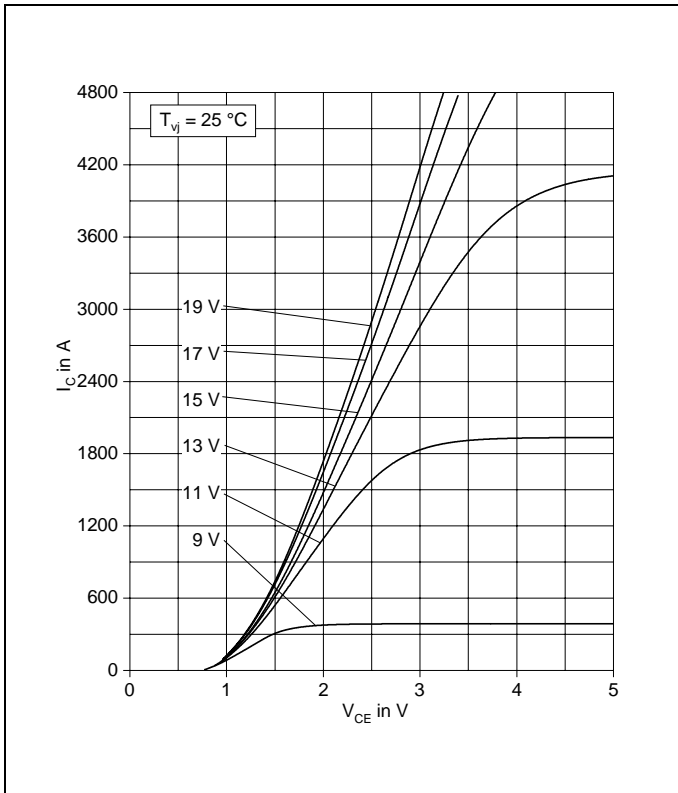

Fig. 3 Typical output characteristics, chip level

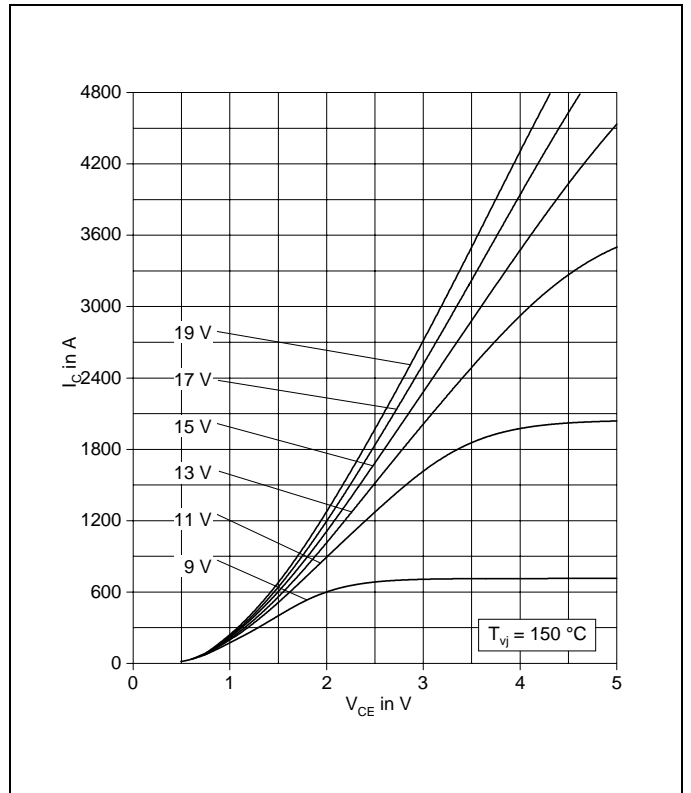

Fig. 4 Typical output characteristics, chip level

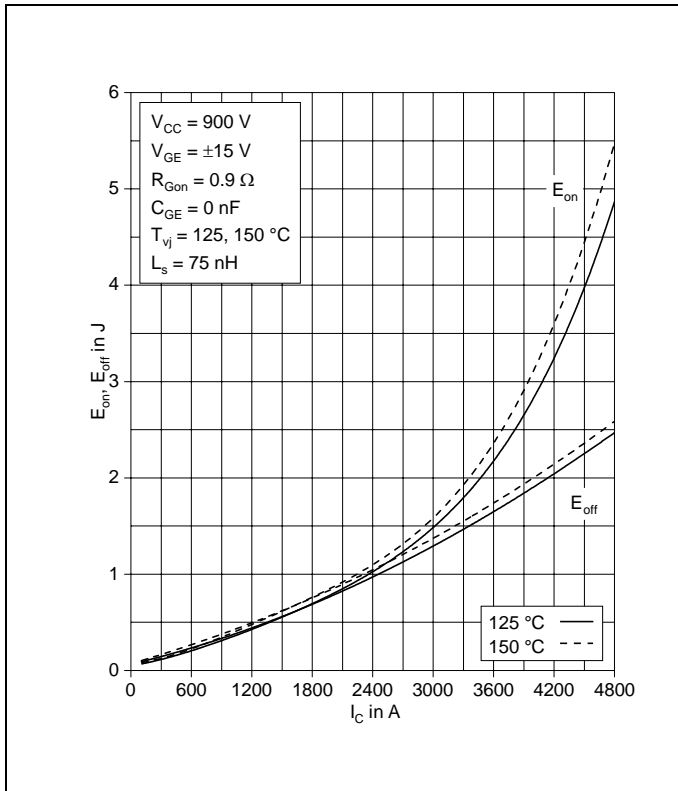

Fig. 5 Typical switching energies per pulse vs. collector current

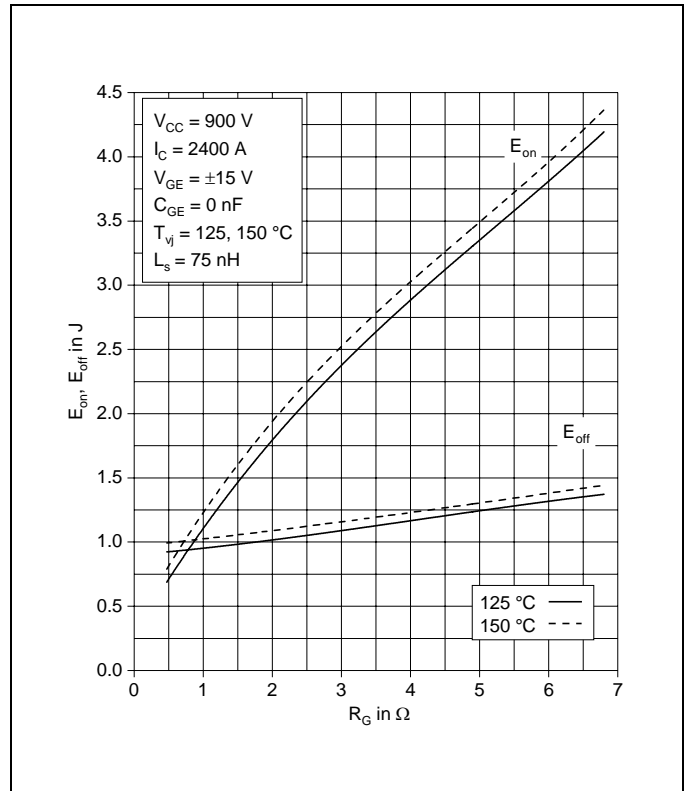

Fig. 6 Typical switching energies per pulse vs. gate resistor

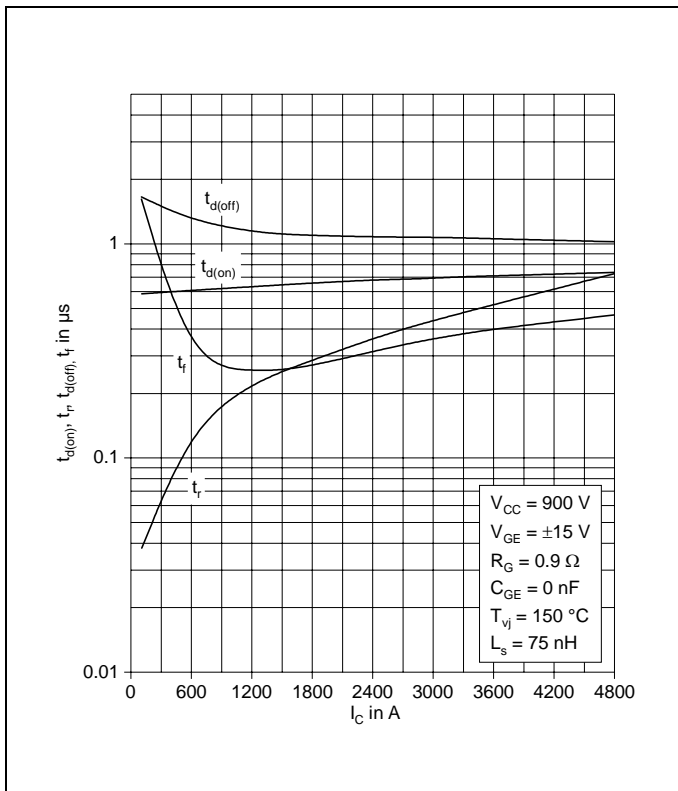

Fig. 7 Typical switching times vs. collector current

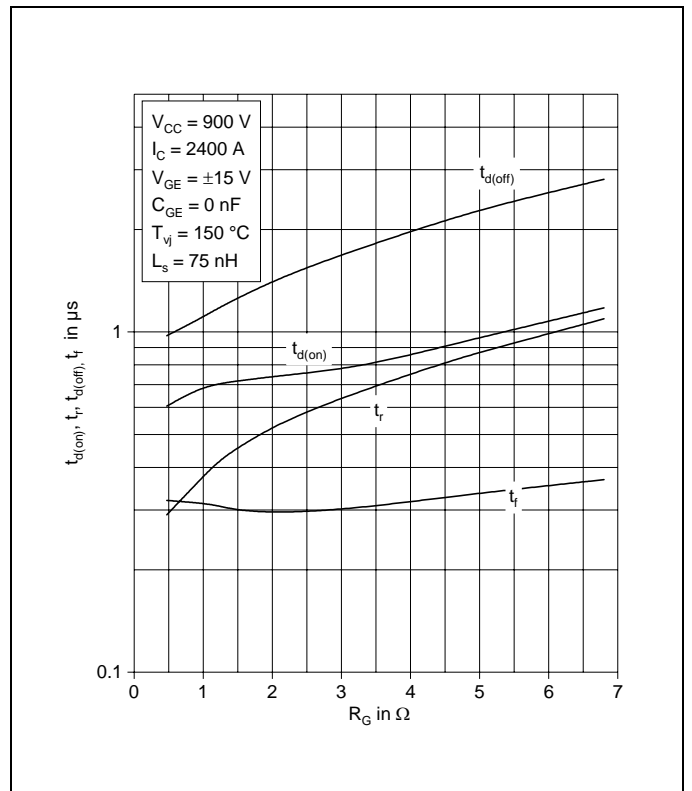

Fig. 8 Typical switching times vs. gate resistor

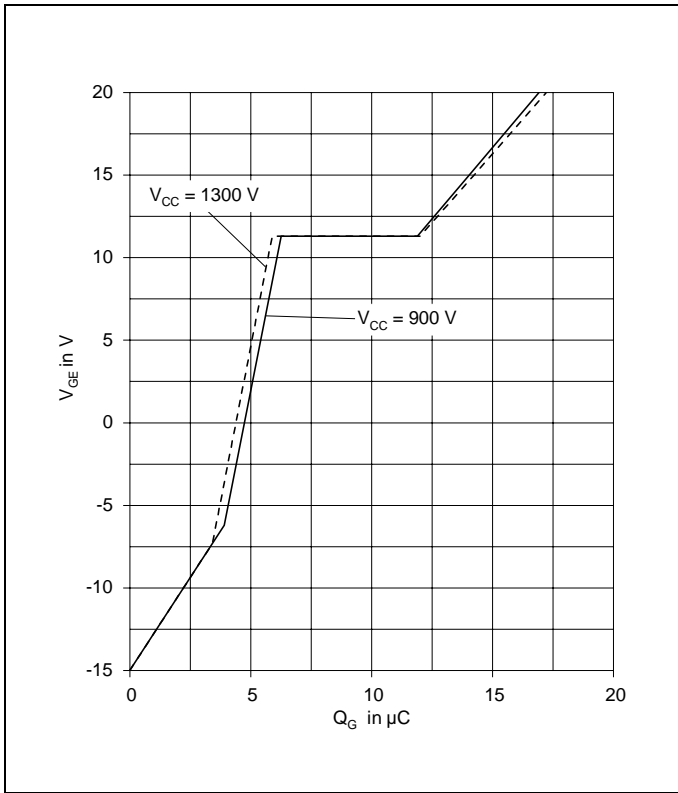

Fig. 9 Typical gate charge characteristics

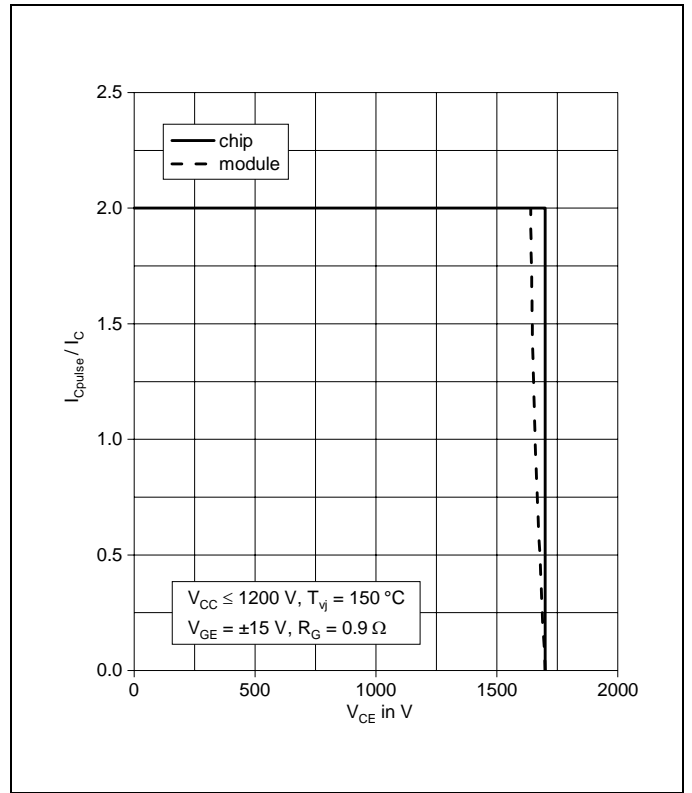

Fig. 10 Turn-off safe operating area (RBSOA)

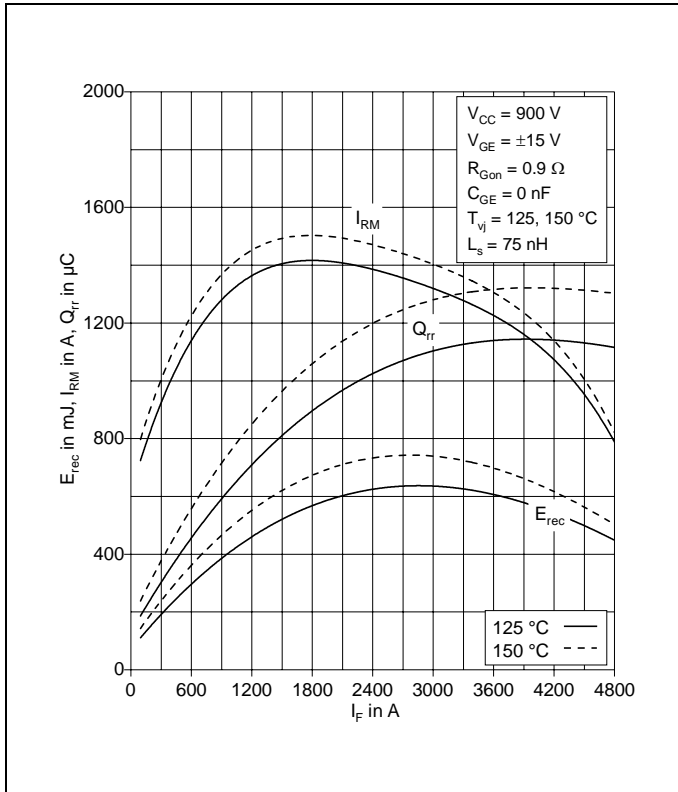

Fig. 11 Typical reverse recovery characteristics vs. forward current

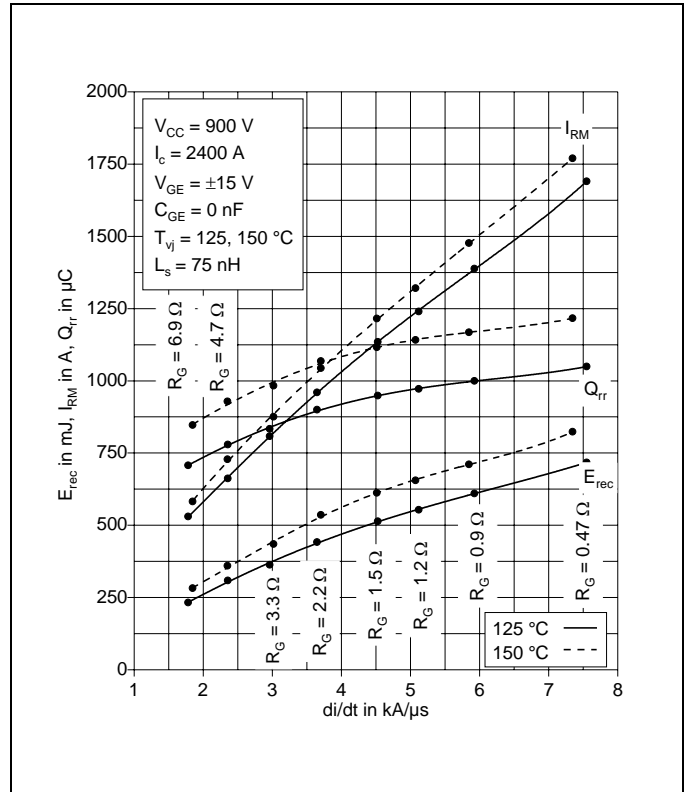

Fig. 12 Typical reverse recovery characteristics vs. di/dt

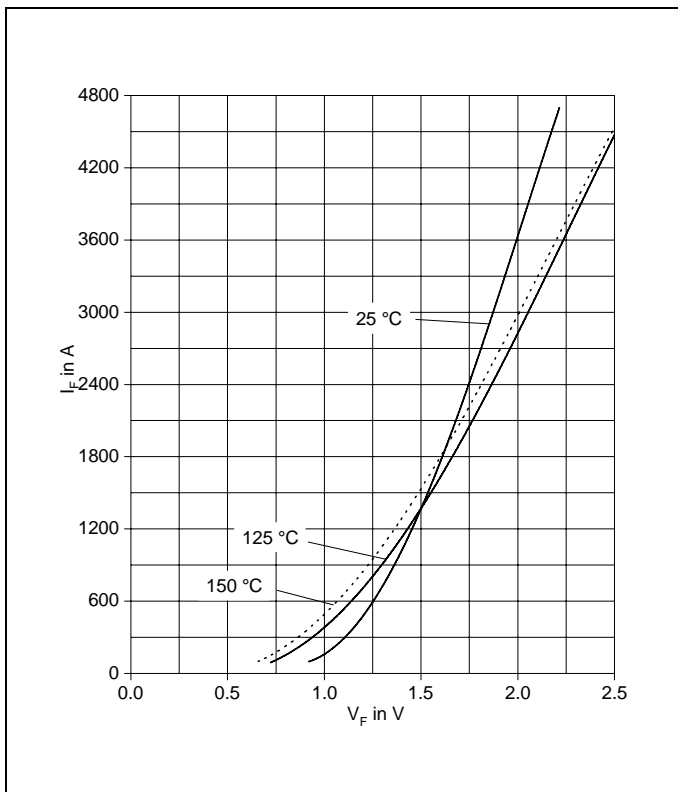

Fig. 13 Typical diode forward characteristics chip level

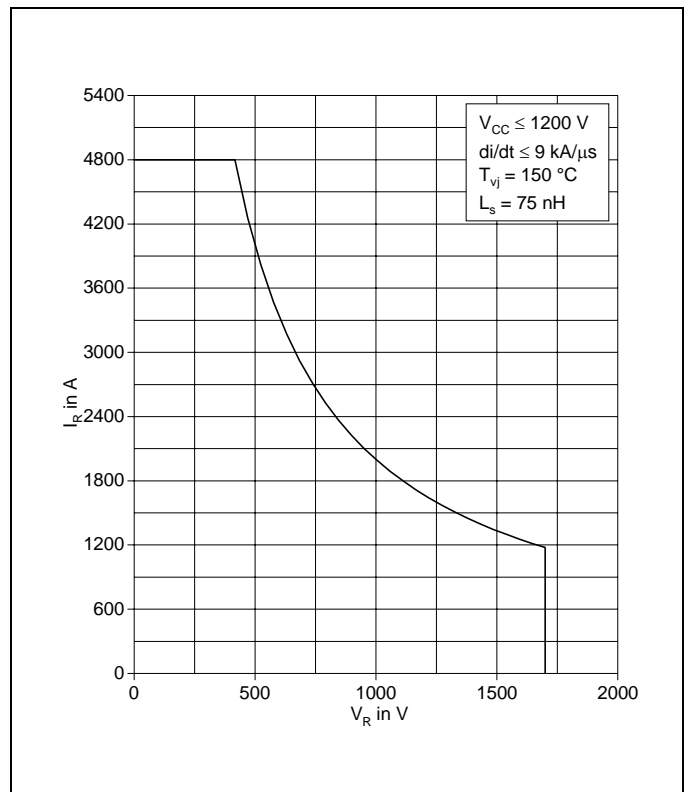

Fig. 14 Safe operating area diode (SOA)

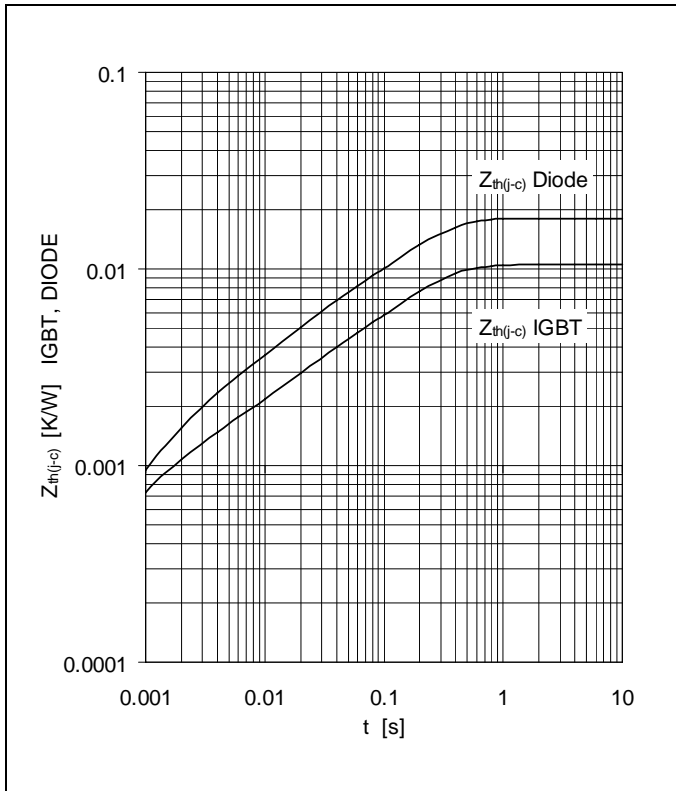

Fig. 15 Thermal impedance vs. time

Analytical function for transient thermal impedance:

$$Z_{th(j-c)}(t) = \sum_{i=1}^n R_i (1 - e^{-t/\tau_i})$$

i	1	2	3	4	5
Ri(K/kW)	7.59	1.8	0.743	0.369	
τ_i (ms)	202	20.3	2.01	0.52	
DIODE					
Ri(K/kW)	12.6	2.89	1.3	1.26	
τ_i (ms)	210	29.6	7.01	1.49	

Related documents:

- 5SYA 2042 Failure rates of HiPak modules due to cosmic rays
- 5SYA 2043 Load - cycle capability of HiPaks
- 5SYA 2045 Thermal runaway during blocking
- 5SYA 2053 Applying IGBT
- 5SYA 2057 IGBT diode safe operating area (SOA)
- 5SYA 2058 Surge currents for IGBT diodes
- 5SYA 2093 Thermal design of IGBT modules
- 5SYA 2098 Paralleling of IGBT modules
- 5SYA 2039 Mounting Instructions for HiPak modules
- 5SZK 9111 Specification of environmental class for HiPak Storage
- 5SZK 9112 Specification of environmental class for HiPak Transportation
- 5SZK 9113 Specification of environmental class for HiPak Operation (Industry)
- 5SZK 9120 Specification of environmental class for HiPak

ABB Power Grids Switzerland Ltd, Semiconductors
 A Hitachi ABB Joint Venture
 Fabrikstrasse 3
 CH-5600 Lenzburg
 Switzerland
www.hitachiabb-powergrids.com/semiconductors

We reserve all rights in this document and in the subject matter and illustrations contained therein. Any reproduction, disclosure to third parties or utilization of its contents - in whole or in parts - is forbidden without prior written consent. Copyright 2020 Hitachi Powergrids. All rights reserved.