

5SLA 3600E170300

HiPak Single DIODE Module

$V_{RRM} = 1700\text{ V}$
 $I_F = 3600\text{ A}$

Ultra low-loss, rugged SPT+ diode
 Smooth switching SPT+ diode for good EMC
 AISiC base-plate for high power cycling capability
 AlN substrate for low thermal resistance
 Improved high reliability package
 Recognized under UL1557, File E196689



Maximum rated values ¹⁾

Parameter	Symbol	Conditions	min	max	Unit
Repetitive peak reverse voltage	V_{RRM}	$T_{vj} \geq 25\text{ °C}$		1700	V
DC forward current	I_F			3600	A
Peak forward current	I_{FRM}	$t_p = 1\text{ ms}$		7200	A
Total power dissipation	P_{tot}	$T_C = 25\text{ °C}, T_{vj} = 150\text{ °C}$		10300	W
Surge current	I_{FSM}	$V_R = 0\text{ V}, T_{vj} = 150\text{ °C}, t_p = 10\text{ ms, half-sinewave}$		18000	A
Isolation voltage	V_{isol}	1 min, $f = 50\text{ Hz}$		4000	V
Junction temperature	T_{vj}			150	°C
Junction operating temperature	$T_{vj(op)}$		-50	150	°C
Case temperature	T_C		-50	150	°C
Storage temperature	T_{stg}		-50	125	°C
Mounting torques ²⁾	M_s	Base- heatsink, M6 screws	4	6	Nm
	M_{t1}	Main terminals, M8 screws	8	10	

¹⁾ Maximum rated values indicate limits beyond which damage to the device may occur per IEC 60747

²⁾ For detailed mounting instructions refer to Document No. 5SYA 2039

Diode characteristic values ³⁾

Parameter	Symbol	Conditions	min	typ	max	Unit	
Forward voltage ⁴⁾	V_F	$I_F = 3600 \text{ A}$	$T_{vj} = 25 \text{ }^\circ\text{C}$	1.85	2.2	V	
			$T_{vj} = 125 \text{ }^\circ\text{C}$		1.95	2.3	V
			$T_{vj} = 150 \text{ }^\circ\text{C}$		1.9		V
Continuous reverse current	I_R	$V_R = 1700 \text{ A}$	$T_{vj} = 25 \text{ }^\circ\text{C}$	0.02		mA	
			$T_{vj} = 125 \text{ }^\circ\text{C}$		20	40	mA
			$T_{vj} = 150 \text{ }^\circ\text{C}$		70		mA
Reverse recovery current	I_{rr}		$T_{vj} = 25 \text{ }^\circ\text{C}$	2030		A	
			$T_{vj} = 125 \text{ }^\circ\text{C}$		2340		A
			$T_{vj} = 150 \text{ }^\circ\text{C}$		2500		A
Recovered charge	Q_{rr}	$V_{CC} = 900 \text{ V},$ $I_F = 3600 \text{ A},$ $di/dt = 11.5 \text{ kA}/\mu\text{s}$ $L_\sigma = 50 \text{ nH},$ inductive load switch: 5SNA 3600E170300	$T_{vj} = 25 \text{ }^\circ\text{C}$	1000		μC	
			$T_{vj} = 125 \text{ }^\circ\text{C}$		1560		μC
			$T_{vj} = 150 \text{ }^\circ\text{C}$		1820		μC
Reverse recovery time	t_{rr}		$T_{vj} = 25 \text{ }^\circ\text{C}$	900		ns	
			$T_{vj} = 125 \text{ }^\circ\text{C}$		1230		ns
			$T_{vj} = 150 \text{ }^\circ\text{C}$		1320		ns
Reverse recovery energy	E_{rec}		$T_{vj} = 25 \text{ }^\circ\text{C}$	710		mJ	
			$T_{vj} = 125 \text{ }^\circ\text{C}$		1080		mJ
			$T_{vj} = 150 \text{ }^\circ\text{C}$		1260		mJ

³⁾ Characteristic values according to IEC 60747 - 2

⁴⁾ Forward voltage is given at chip level

Package properties ⁵⁾

Parameter	Symbol	Conditions	min	typ	max	Unit
Diode thermal resistance junction to case	$R_{th(j-c)DIODE}$				0.012	K/W
Diode thermal resistance ²⁾ case to heatsink	$R_{th(c-s)DIODE}$	Diode, λ grease = 1W/m x K		0.018		K/W
Comparative tracking index	CTI		600			
Module stray inductance	$L_{\sigma AC}$			8		nH
Resistance, terminal-chip	$R_{AA'+CC'}$		$T_C = 25 \text{ }^\circ\text{C}$	0.055		m Ω
			$T_C = 125 \text{ }^\circ\text{C}$		0.075	
			$T_C = 150 \text{ }^\circ\text{C}$		0.080	

²⁾ For detailed mounting instructions refer to ABB Document No. 5SYA 2039

Mechanical properties ⁵⁾

Parameter	Symbol	Conditions	min	typ	max	Unit
Dimensions	L x W x H	Typical		190 x 140 x 38		mm
Clearance distance in air	d_a	according to IEC 60664-1 and EN 50124-1	Term. to base:	23		mm
			Term. to term:	19		
Surface creepage distance	d_s	according to IEC 60664-1 and EN 50124-1	Term. to base:	28.2		mm
			Term. to term:	28.2		
Mass	m			1200		g

⁵⁾ Package and mechanical properties according to IEC 60747 - 15

Electrical configuration

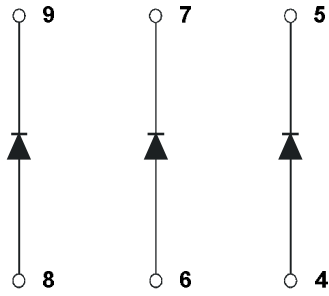

Outline drawing ²⁾

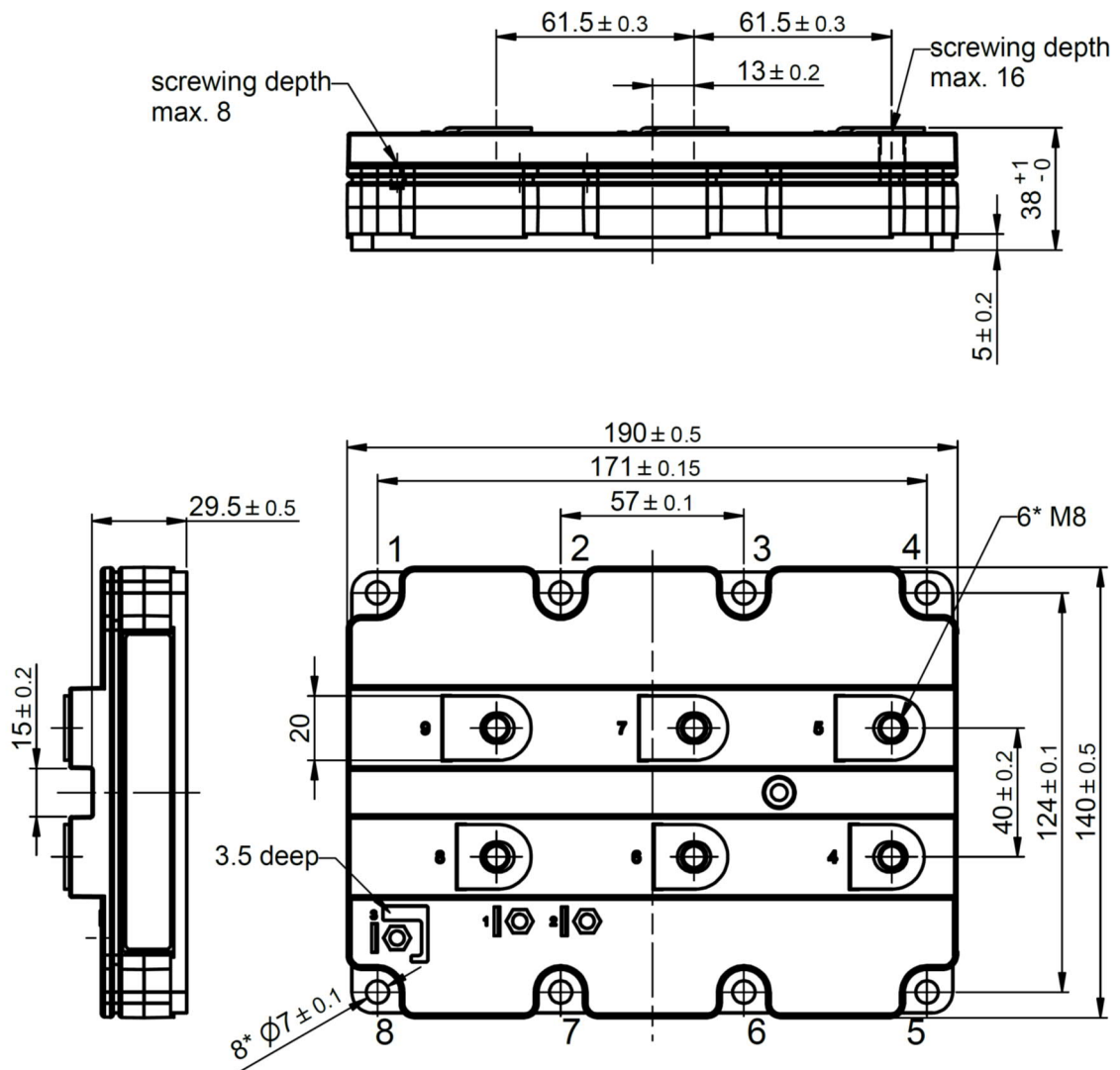

Note: all dimensions are shown in millimeters
²⁾ For detailed mounting instructions refer to Document No. 5SYA 2039

This is an electrostatic sensitive device, please observe the international standard IEC 60747-1, chap. IX.
 This product has been designed and qualified for Industrial Level.

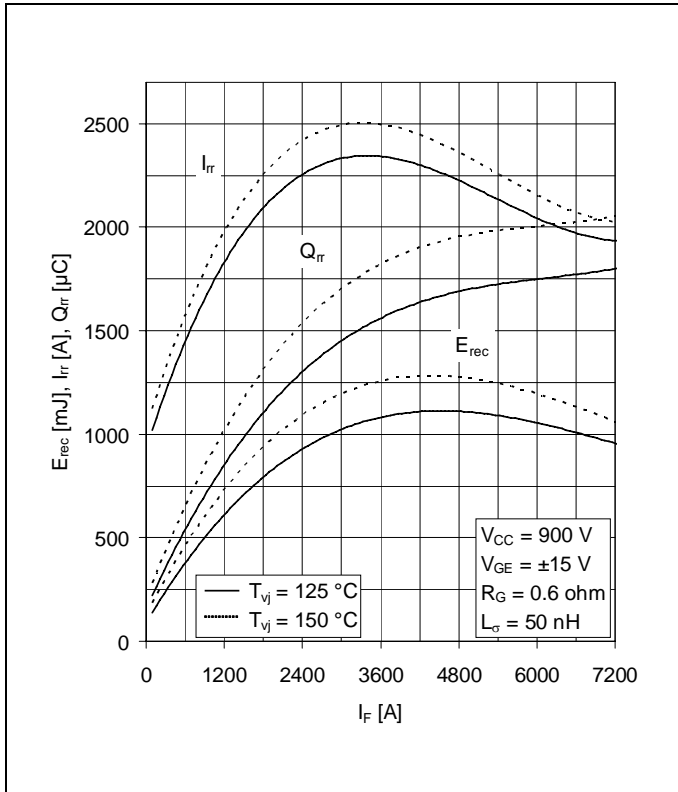

Fig. 1 Typical reverse recovery characteristics vs. forward current

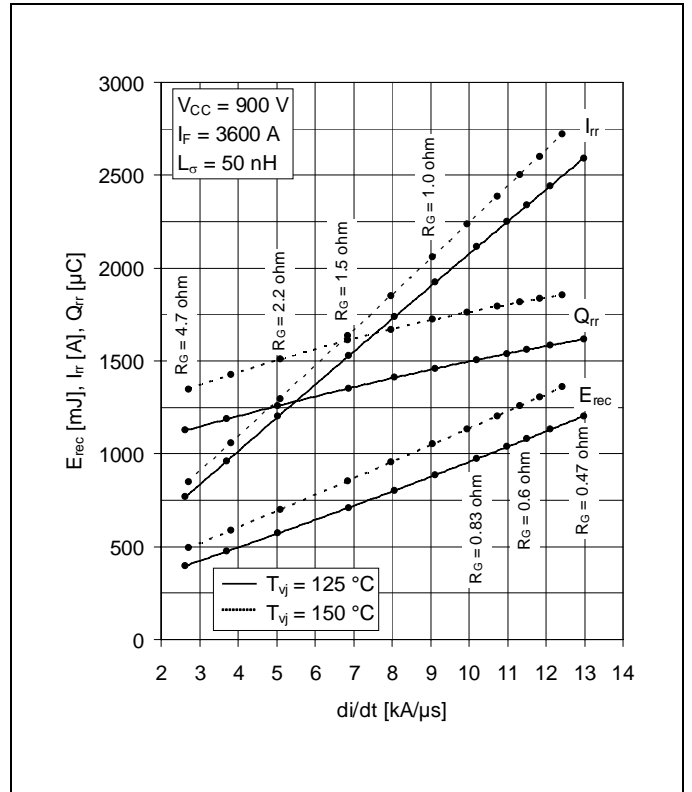

Fig. 2 Typical reverse recovery characteristics vs. di/dt

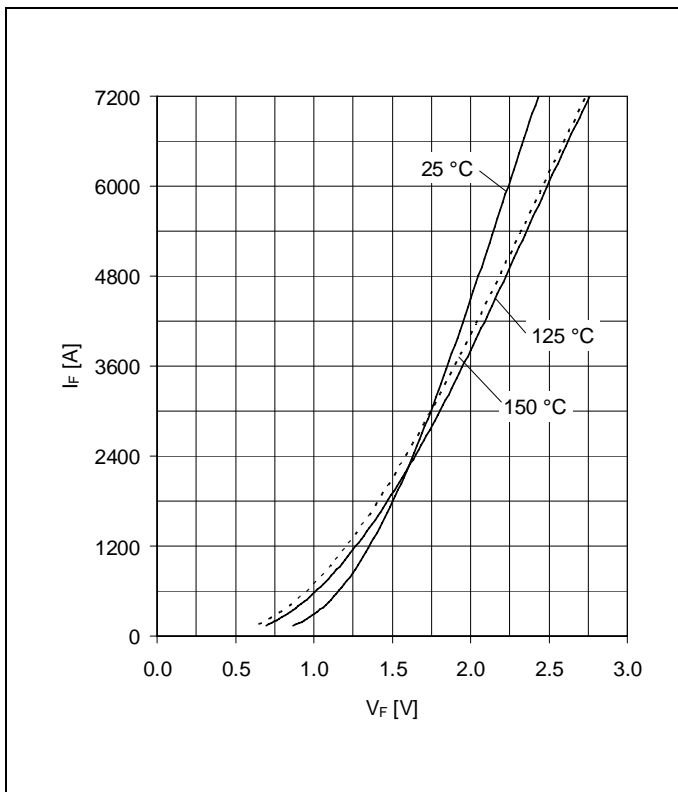

Fig. 3 Typical diode forward characteristics chip level

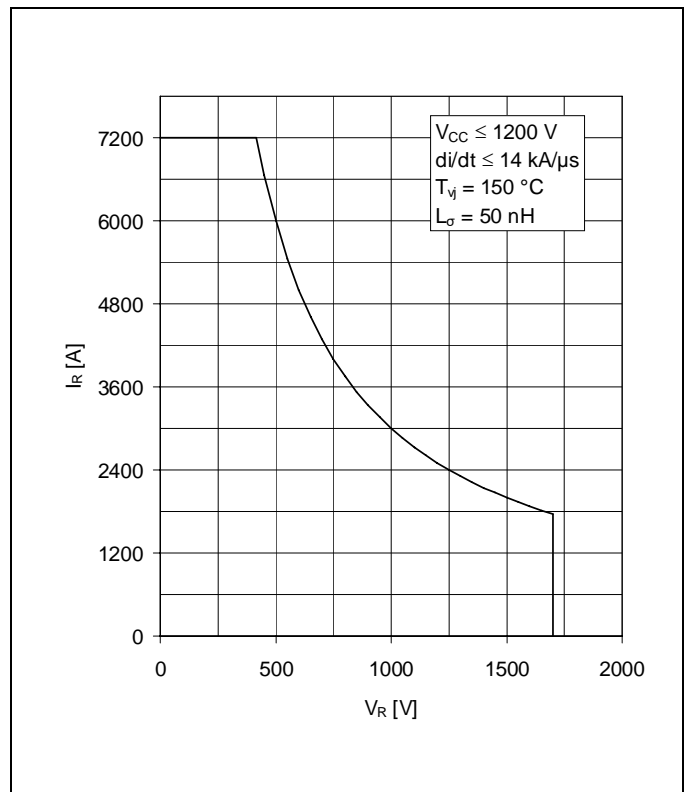

Fig. 4 Safe operating area diode (SOA)

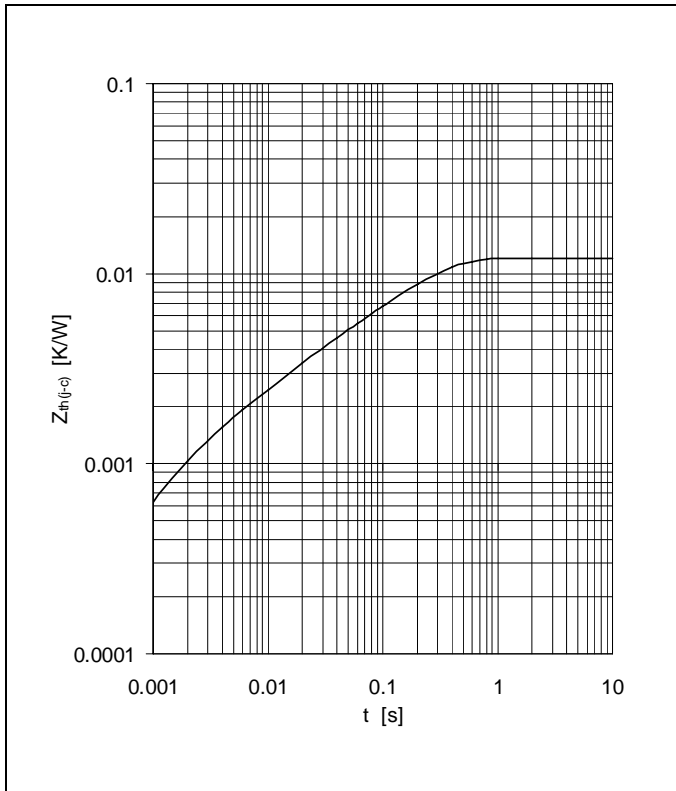

Fig. 5 Thermal impedance vs. time

Analytical function for transient thermal impedance:

$$Z_{th(j-c)}(t) = \sum_{i=1}^n R_i (1 - e^{-t/\tau_i})$$

DIODE	Ri(K/kW)	8.432	1.928	0.866	0.839	
	τi(ms)	210	29.6	7.01	1.49	

Related documents:

- 5SYA 2042 Failure rates of HiPak modules due to cosmic rays
- 5SYA 2043 Load - cycle capability of HiPaks
- 5SYA 2045 Thermal runaway during blocking
- 5SYA 2058 Surge currents for IGBT diodes
- 5SZK 9111 Specification of environmental class for HiPak Storage
- 5SZK 9112 Specification of environmental class for HiPak Transportation
- 5SZK 9113 Specification of environmental class for HiPak Operation (Industry)
- 5SZK 9120 Specification of environmental class for HiPak

We reserve all rights in this document and in the subject matter and illustrations contained therein. Any reproduction, disclosure to third parties or utilization of its contents - in whole or in parts - is forbidden without prior written consent. Copyright 2020 Hitachi Powergrids. All rights reserved.

ABB Power Grids Switzerland Ltd, Semiconductors
 A Hitachi ABB Joint Venture
 Fabrikstrasse 3
 CH-5600 Lenzburg
 Switzerland
www.hitachiabb-powergrids.com/semiconductors