

V_{DRM}	=	4500 V
I_{TGQM}	=	3000 A
I_{TSM}	=	24 kA
V_{T0}	=	1.80 V
r_T	=	0.70 m Ω
V_{DClin}	=	3000 V

Gate turn-off Thyristor

5SGF 30J4502

PRELIMINARY

Doc. No. 5SYA 1211-04 Aug. 2000

- Patented free-floating silicon technology
- Low on-state and switching losses
- Annular gate electrode
- Industry standard housing
- Cosmic radiation withstand rating

The 5SGF 30J4502 is a 85 mm buffered layer GTO with exceptionally low dynamic and static losses designed to retro-fit all former 3 kA GTOs of the same voltage. It offers optimal trade-off between on-state and switching losses and is encapsulated in an industry-standard press pack housing 108 mm wide and 26 mm thick.

Blocking

V_{DRM}	Repetitive peak off-state voltage	4500 V	$V_{GR} \geq 2V$
V_{RRM}	Repetitive peak reverse voltage	17 V	
I_{DRM}	Repetitive peak off-state current	≤ 100 mA	$V_D = V_{DRM}$ $V_{GR} \geq 2V$
I_{RRM}	Repetitive peak reverse current	≤ 50 mA	$V_R = V_{RRM}$ $R_{GK} = \infty$
V_{DClink}	Permanent DC voltage for 100 FIT failure rate	3000 V	$-40 \leq T_j \leq 125$ °C. Ambient cosmic radiation at sea level in open air.

Mechanical data (see Fig. 19)

F_m	Mounting force	min.	28	kN
		max.	38	kN
A	Acceleration:			
	Device unclamped		50	m/s ²
	Device clamped		200	m/s ²
M	Weight		1.3	kg
D_s	Surface creepage distance	\geq	33	mm
D_a	Air strike distance	\geq	15	mm

ABB Semiconductors AG reserves the right to change specifications without notice.



GTO Data**On-state**

I_{TAVM}	Max. average on-state current	960 A	Half sine wave, $T_C = 85\text{ °C}$	
I_{TRMS}	Max. RMS on-state current	1510 A		
I_{TSM}	Max. peak non-repetitive surge current	24 kA	$t_P = 10\text{ ms}$	$T_j = 125\text{ °C}$ After surge: $V_D = V_R = 0V$
		40 kA	$t_P = 1\text{ ms}$	
I^2t	Limiting load integral	$2.88 \cdot 10^6\text{ A}^2\text{s}$	$t_P = 10\text{ ms}$	
		$0.80 \cdot 10^6\text{ A}^2\text{s}$	$t_P = 1\text{ ms}$	
V_T	On-state voltage	3.90 V	$I_T = 3000\text{ A}$	$T_j = 125\text{ °C}$
V_{T0}	Threshold voltage	1.80 V	$I_T = 400 - 4000\text{ A}$	
r_T	Slope resistance	0.70 m Ω		
I_H	Holding current	100 A	$T_j = 25\text{ °C}$	

Gate

V_{GT}	Gate trigger voltage	1.2 V	$V_D = 24\text{ V}$	$T_j = 25\text{ °C}$
I_{GT}	Gate trigger current	2.5 A	$R_A = 0.1\text{ }\Omega$	
V_{GRM}	Repetitive peak reverse voltage	17 V		
I_{GRM}	Repetitive peak reverse current	20 mA	$V_{GR} = V_{GRM}$	

Turn-on switching

di/dt_{crit}	Max. rate of rise of on-state current	500 A/ μs	$f = 200\text{ Hz}$	$I_T = 3000\text{ A}, T_j = 125\text{ °C}$ $I_{GM} = 25\text{ A}, di_G/dt = 20\text{ A}/\mu\text{s}$
		1000 A/ μs	$f = 1\text{ Hz}$	
t_d	Delay time	2.5 μs	$V_D = 0.5 V_{DRM}$	$T_j = 125\text{ °C}$
t_r	Rise time	5.0 μs	$I_T = 3000\text{ A}$	$di/dt = 300\text{ A}/\mu\text{s}$
$t_{on(min)}$	Min. on-time	100 μs	$I_{GM} = 25\text{ A}$	$di_G/dt = 20\text{ A}/\mu\text{s}$
E_{on}	Turn-on energy per pulse	2.50 Ws	$C_S = 3\text{ }\mu\text{F}$	$R_S = 5\text{ }\Omega$

Turn-off switching

I_{TGQM}	Max controllable turn-off current	3000 A	$V_{DM} = V_{DRM}$	$di_{GQ}/dt = 40\text{ A}/\mu\text{s}$
			$C_S = 3\text{ }\mu\text{F}$	$L_S \leq 0.2\text{ }\mu\text{H}$
t_s	Storage time	25.0 μs	$V_D = \frac{1}{2} V_{DRM}$	$V_{DM} = V_{DRM}$
t_f	Fall time	3.0 μs	$T_j = 125\text{ °C}$	$di_{GQ}/dt = 40\text{ A}/\mu\text{s}$
$t_{off(min)}$	Min. off-time	100 μs	$I_{TGQ} = I_{TGQM}$	
E_{off}	Turn-off energy per pulse	10.0 Ws	$C_S = 3\text{ }\mu\text{F}$	$R_S = 5\text{ }\Omega$
I_{GQM}	Peak turn-off gate current	800 A	$L_S \leq 0.2\text{ }\mu\text{H}$	

Thermal

T_j	Storage and operating junction temperature range	-40...125°C	
R_{thJC}	Thermal resistance junction to case	22 K/kW	Anode side cooled
		27 K/kW	Cathode side cooled
		12 K/kW	Double side cooled
R_{thCH}	Thermal resistance case to heat sink	6 K/kW	Single side cooled
		3 K/kW	Double side cooled

Analytical function for transient thermal impedance:

$$Z_{thJC}(t) = \sum_{i=1}^4 R_i (1 - e^{-t/\tau_i})$$

i	1	2	3	4
R_i (K/kW)	5.4	4.5	1.7	0.4
τ_i (s)	1.2	0.17	0.01	0.001

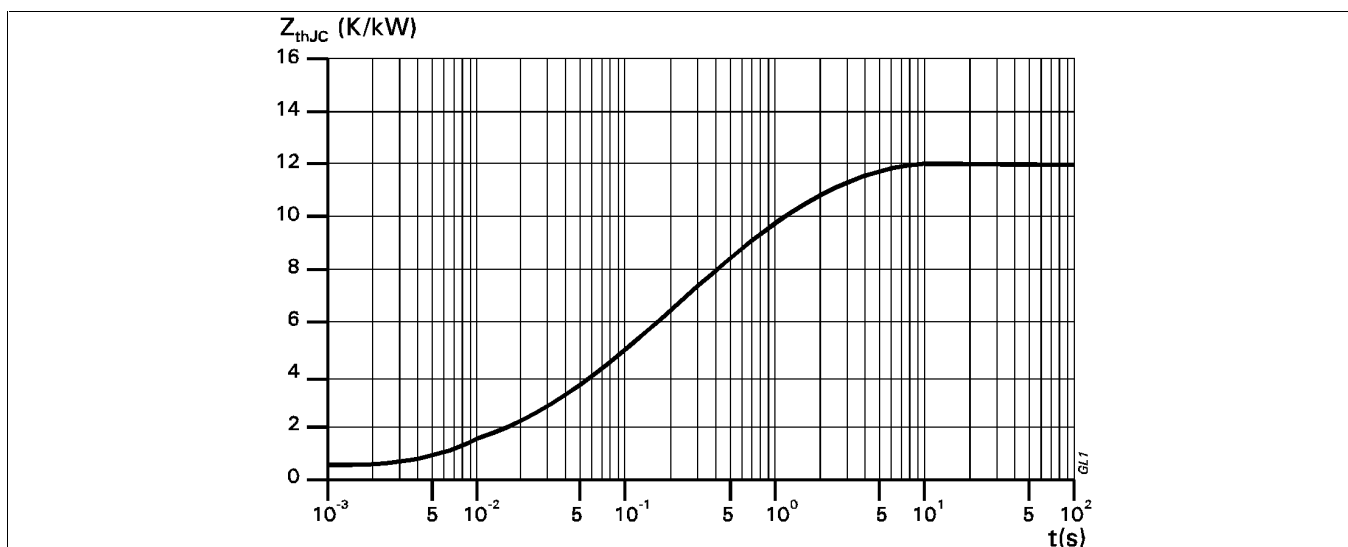
**Fig. 1** Transient thermal impedance, junction to case.

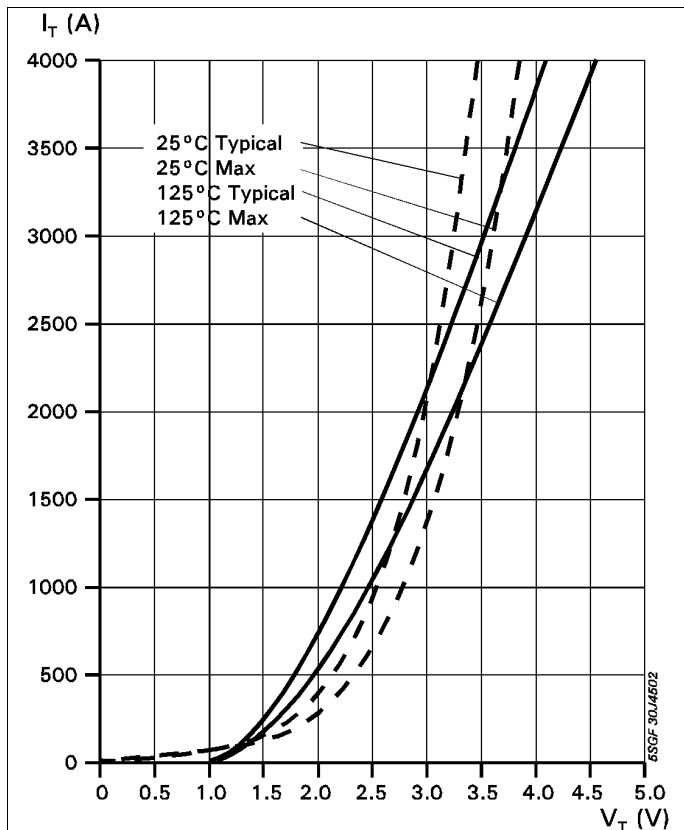

Fig. 2 On-state characteristics

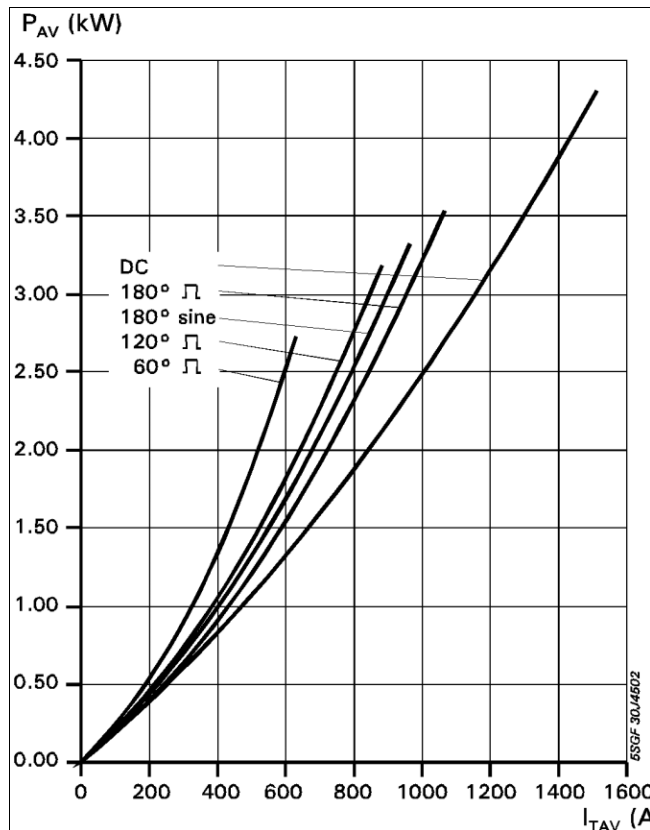

Fig. 3 Average on-state power dissipation vs. average on-state current.

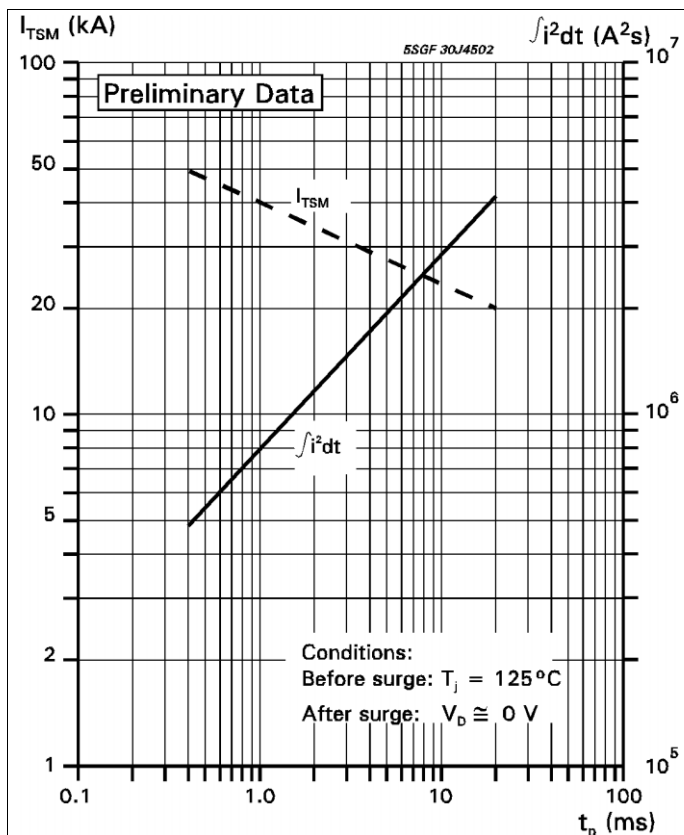

Fig. 4 Surge current and fusing integral vs. pulse width

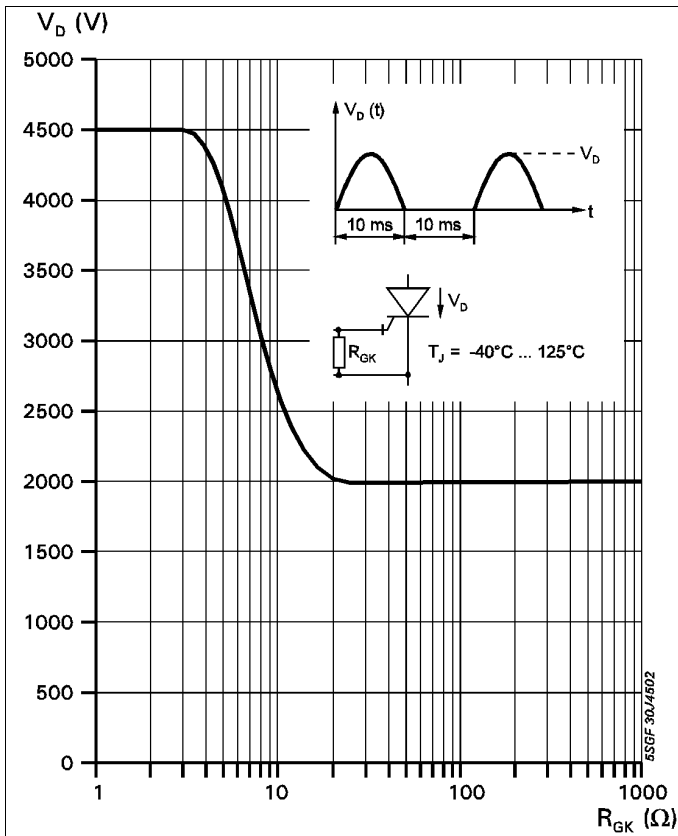

Fig. 5 Forward blocking voltage vs. gate-cathode resistance.

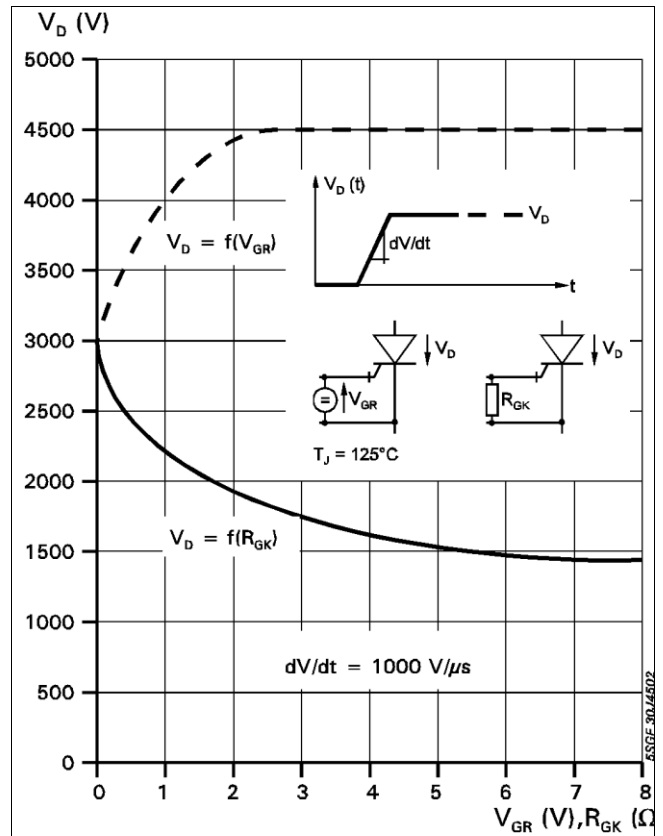

Fig. 6 Static dv/dt capability: Forward blocking voltage vs. neg. gate voltage or gate cathode resistance.

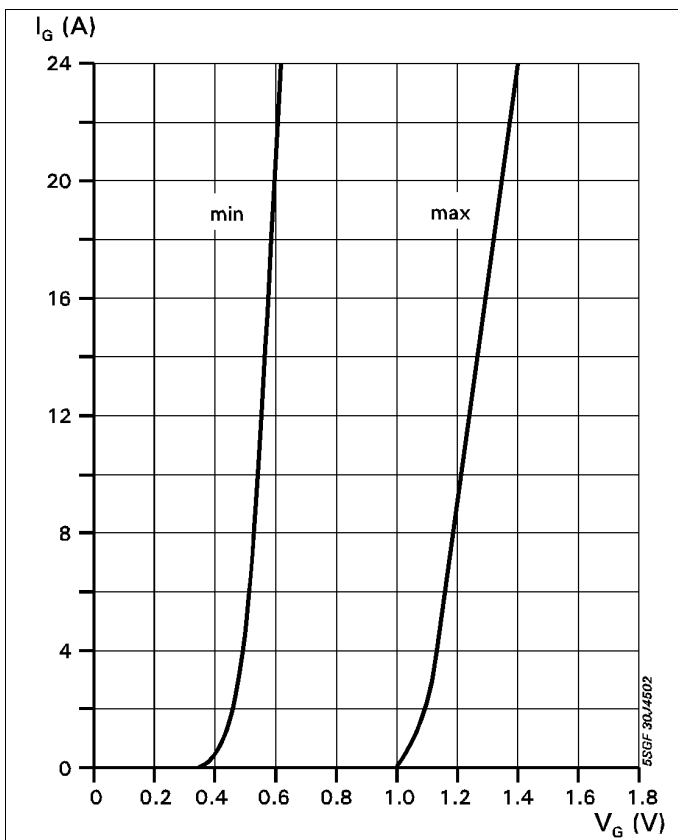

Fig. 7 Forward gate current vs. forward gate voltage.

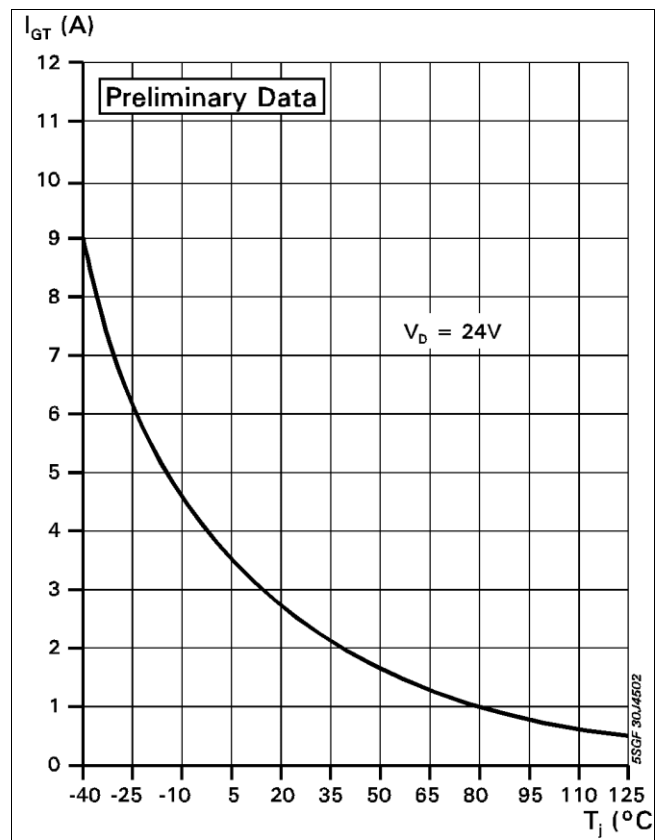

Fig. 8 Gate trigger current vs. junction temperature

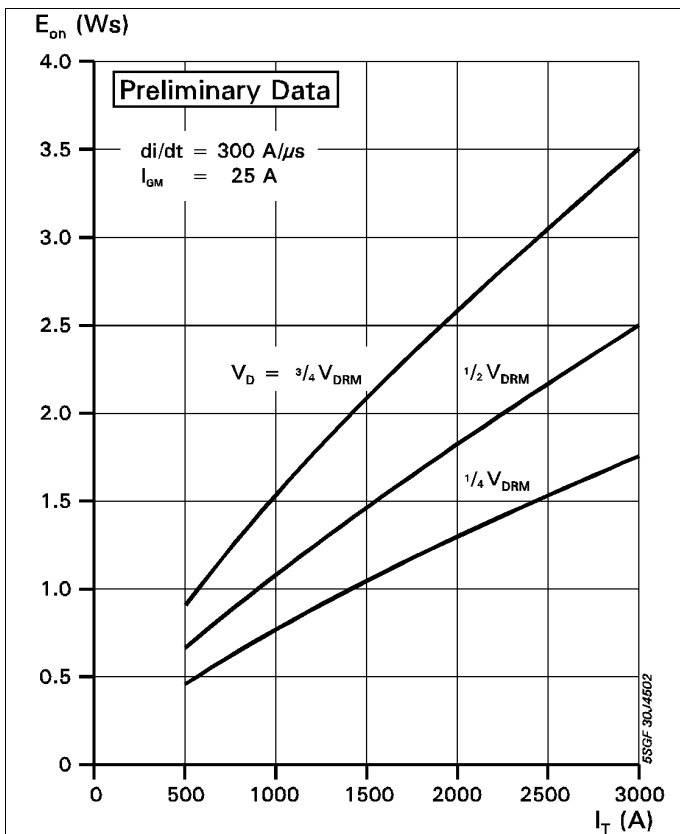

Fig. 9 Turn-on energy per pulse vs. on-state current and turn-on voltage.

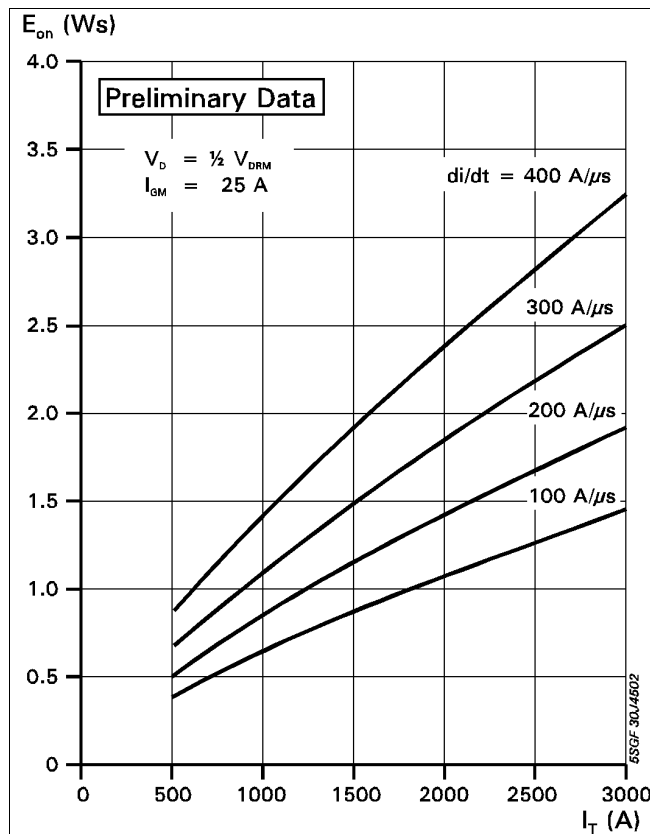

Fig. 10 Turn-on energy per pulse vs. on-state current and current rise rate

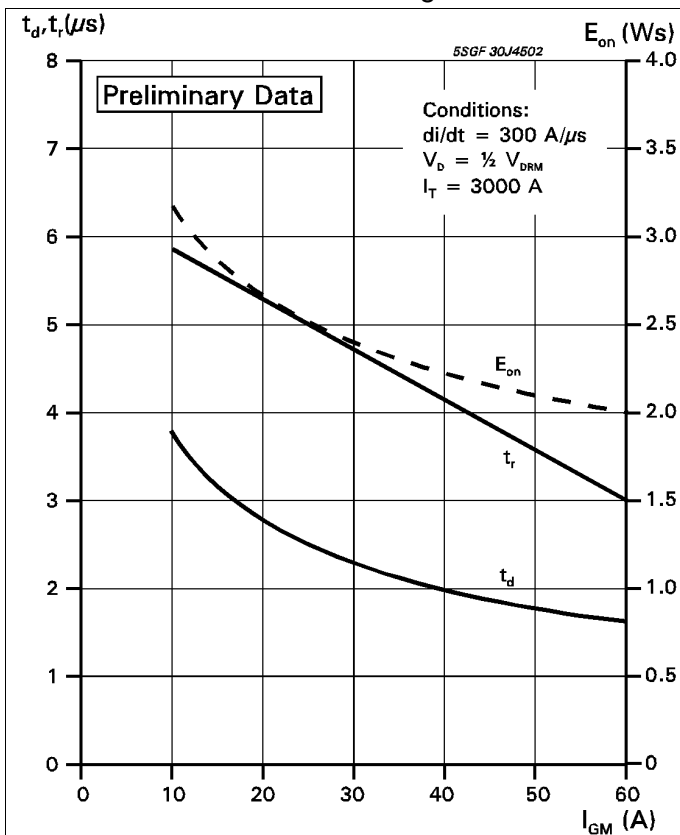

Fig. 11 Turn-on energy per pulse vs. on-state current and turn-on voltage.

Common Test conditions for figures 9, 10 and 11:

- $di_G/dt = 20 \text{ A}/\mu\text{s}$
- $C_S = 3 \mu\text{F}$
- $R_S = 5 \Omega$
- $T_j = 125 \text{ }^\circ\text{C}$

Definition of Turn-on energy:

$$E_{on} = \int_0^{20 \mu\text{s}} V_D \cdot I_T dt \quad (t = 0, I_G = 0.1 \cdot I_{GM})$$

Common Test conditions for figures 12, 13 and 15:

Definition of Turn-off energy:

$$E_{off} = \int_0^{40 \mu\text{s}} V_D \cdot I_T dt \quad (t = 0, I_T = 0.9 \cdot I_{TQ})$$

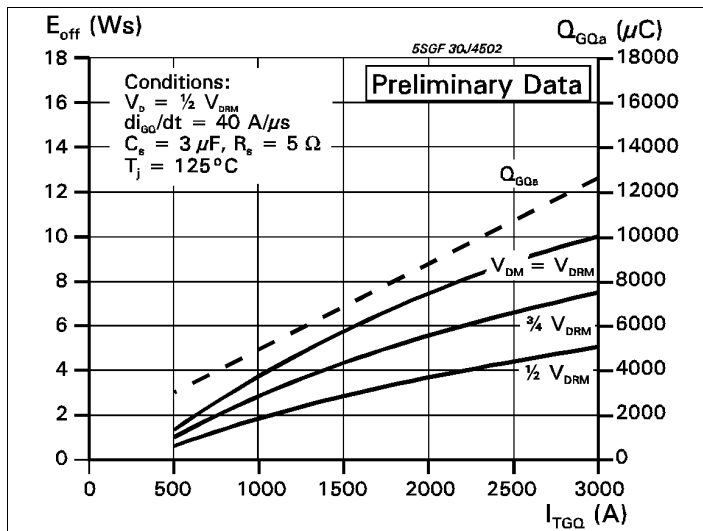

Fig. 12 Turn-off energy per pulse vs. turn-off current and peak turn-off voltage. Extracted gate charge vs. turn-off current.

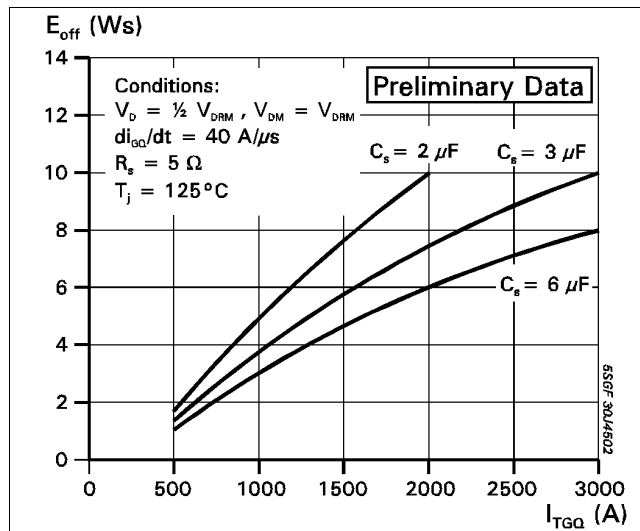

Fig. 13 Turn-off energy per pulse vs. turn-off current and snubber capacitance.

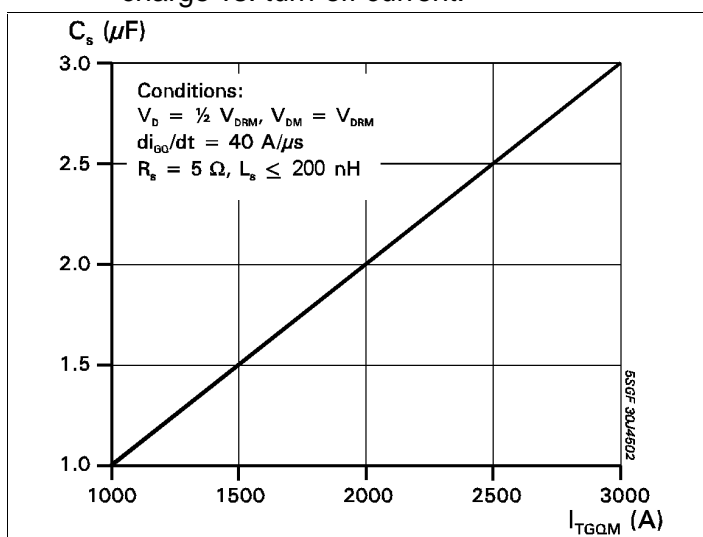

Fig. 14 Required snubber capacitor vs. max allowable turn-off current.

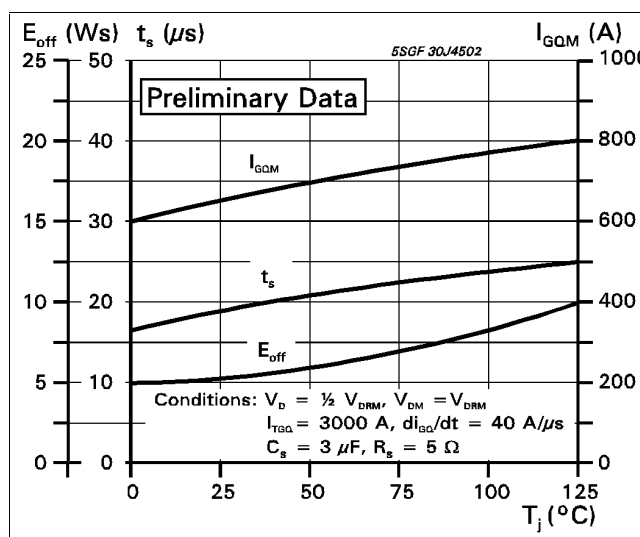

Fig. 15 Turn-off energy per pulse, storage time and peak turn-off gate current vs. junction temperature

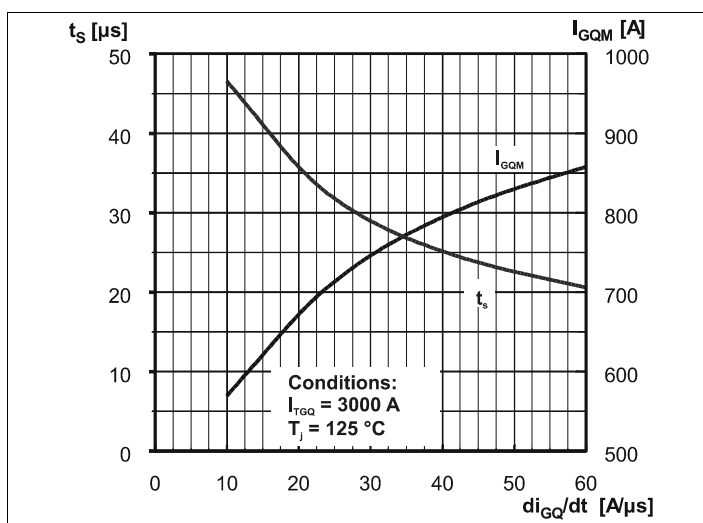

Fig. 16 Storage time and peak turn-off gate current vs. neg. gate current rise rate.

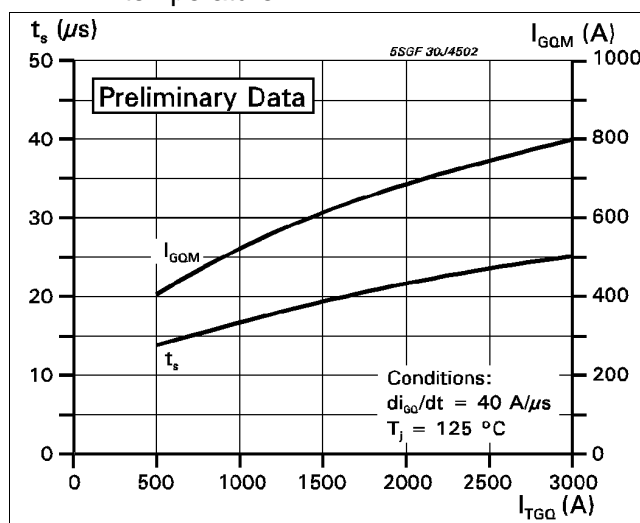

Fig. 17 Storage time and peak turn-off gate current vs. turn-off current

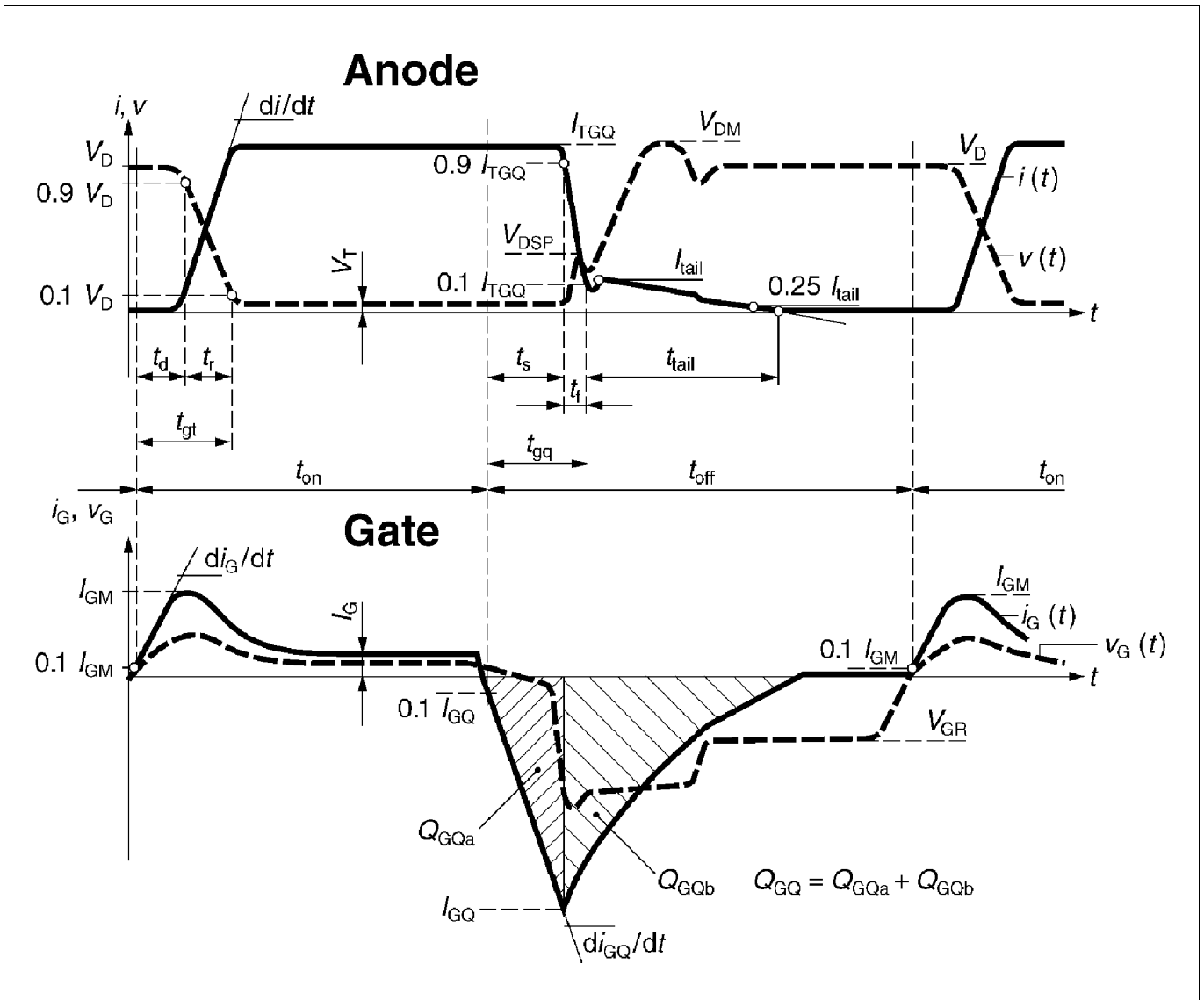

Fig. 18 General current and voltage waveforms with GTO-specific symbols

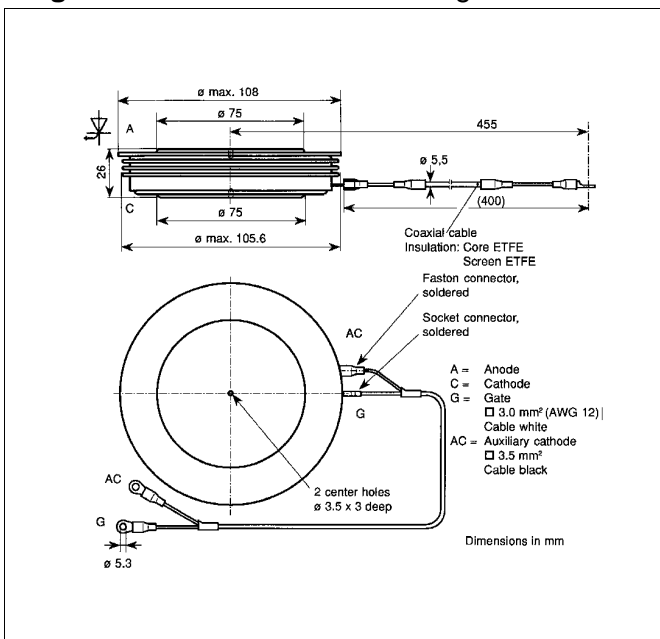

Fig. 19 Outline drawing. All dimensions are in millimeters and represent nominal values unless stated otherwise.

Reverse avalanche capability

In operation with an antiparallel freewheeling diode, the GTO reverse voltage V_R may exceed the rated value V_{RRM} due to stray inductance and diode turn-on voltage spike at high di/dt . The GTO is then driven into reverse avalanche. This condition is not dangerous for the GTO provided avalanche time and current are below 10 μ s and 1000 A respectively. However, gate voltage must remain negative during this time. Recommendation : $V_{GR} = 10 \dots 15$ V.

ABB Semiconductors AG reserves the right to change specifications without notice.



ABB Semiconductors AG
Fabrikstrasse 2
CH-5600 Lenzburg, Switzerland

Doc. No. 5SYA 1211-04 Aug. 2000

Tel: +41 (0)62 888 6419
Fax: +41 (0)62 888 6306
E-mail info@ch.abb.com
Internet www.abbsem.com