

V_{RRM}	=	2500 V
I_{FAVM}	=	420 A
I_{FSM}	=	8.5 kA
V_{F0}	=	1.7 V
r_F	=	0.62 m Ω
V_{DClink}	=	1500 V

Fast Recovery Diode

5SDF 05D2505

Doc. No. 5SYA 1114-03 Aug. 2000

- Patented free-floating silicon technology
- Low on-state and switching losses
- Optimized for use as freewheeling diode in GTO converters
- Standard press-pack housing, hermetically cold-welded
- Cosmic radiation withstand rating

Blocking

V_{RRM}	Repetitive peak reverse voltage	2500 V	Half sine wave, $t_p = 10$ ms, $f = 50$ Hz	
I_{RRM}	Repetitive peak reverse current	≤ 50 mA	$V_R = V_{RRM}$, $T_j = 125^\circ\text{C}$	
V_{DClink}	Permanent DC voltage for 100 FIT failure rate	1500 V	100% Duty	Ambient cosmic radiation at sea level in open air.

Mechanical data (see Fig. 11)

F_m	Mounting force	min.	10 kN
		max.	12 kN
a	Acceleration:		
	Device unclamped	50 m/s ²	
	Device clamped	200 m/s ²	
m	Weight	0.25 kg	
D_s	Surface creepage distance	\geq	30 mm
D_a	Air strike distance	\geq	20 mm

On-state (see Fig. 1, 2)

I_{FAVM}	Max. average on-state current	420 A	Half sine wave, $T_c = 85^\circ\text{C}$	
I_{FRMS}	Max. RMS on-state current	670 A		
I_{FSM}	Max. peak non-repetitive surge current	8.5 kA	$t_p = 10\text{ ms}$	Before surge: $T_c = T_j = 125^\circ\text{C}$
		27 kA	$t_p = 1\text{ ms}$	
$\int I^2 dt$	Max. surge current integral	$0.36 \cdot 10^6\text{ A}^2\text{s}$	$t_p = 10\text{ ms}$	After surge: $V_R \approx 0\text{ V}$
		$0.36 \cdot 10^6\text{ A}^2\text{s}$	$t_p = 1\text{ ms}$	
V_F	Forward voltage drop	$\leq 2.3\text{ V}$	$I_F = 1000\text{ A}$	$T_j = 125^\circ\text{C}$
V_{F0}	Threshold voltage	1.7 V	Approximation for	
r_F	Slope resistance	0.62 m Ω	$I_F = 500 \dots 3500\text{ A}$	

Turn-on (see Fig. 3, 4)

V_{fr}	Peak forward recovery voltage	$\leq 16\text{ V}$	$di/dt = 500\text{ A}/\mu\text{s}$, $T_j = 125^\circ\text{C}$
----------	-------------------------------	--------------------	--

Turn-off (see Fig. 5 to 10)

I_{rr}	Reverse recovery current	$\leq 470\text{ A}$	$di/dt = 100\text{ A}/\mu\text{s}$, $I_F = 2000\text{ A}$, $T_j = 125^\circ\text{C}$, $V_{RM} = 2500\text{ V}$, $C_S = \mu\text{F}$ (GTO snubber circuit)
Q_{rr}	Reverse recovery charge	$\leq 840\text{ }\mu\text{C}$	
E_{rr}	Turn-off energy	$\leq 0.34\text{ J}$	

Thermal (see Fig. 12)

T_j	Operating junction temperature range	-40...125 $^\circ\text{C}$		
T_{stg}	Storage temperature range	-40...125 $^\circ\text{C}$		
R_{thJC}	Thermal resistance junction to case	$\leq 80\text{ K/kW}$	Anode side cooled	$F_M = 10 \dots 12\text{ kN}$
		$\leq 80\text{ K/kW}$	Cathode side cooled	
		$\leq 40\text{ K/kW}$	Double side cooled	
R_{thCH}	Thermal resistance case to heatsink	$\leq 16\text{ K/kW}$	Single side cooled	
		$\leq 8\text{ K/kW}$	Double side cooled	

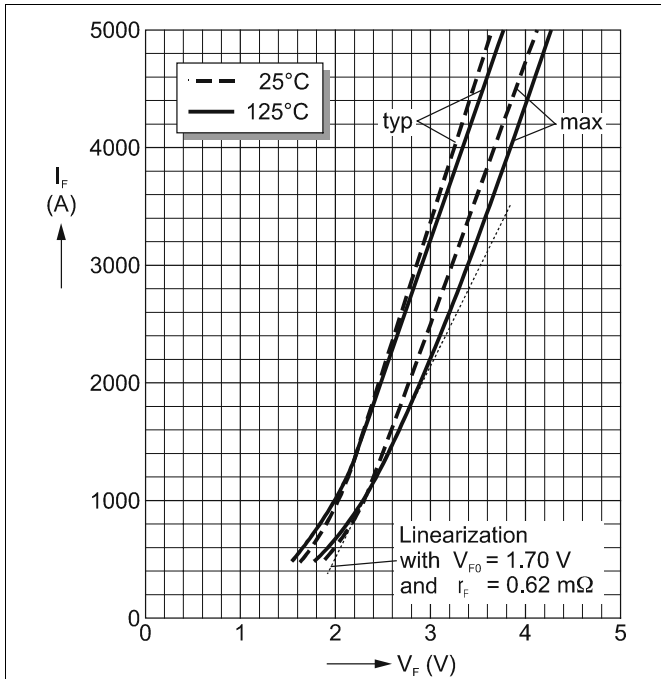

Fig. 1 Forward current vs. forward voltage (typ. and max. values) and linear approximation of max. curve at 125°C.

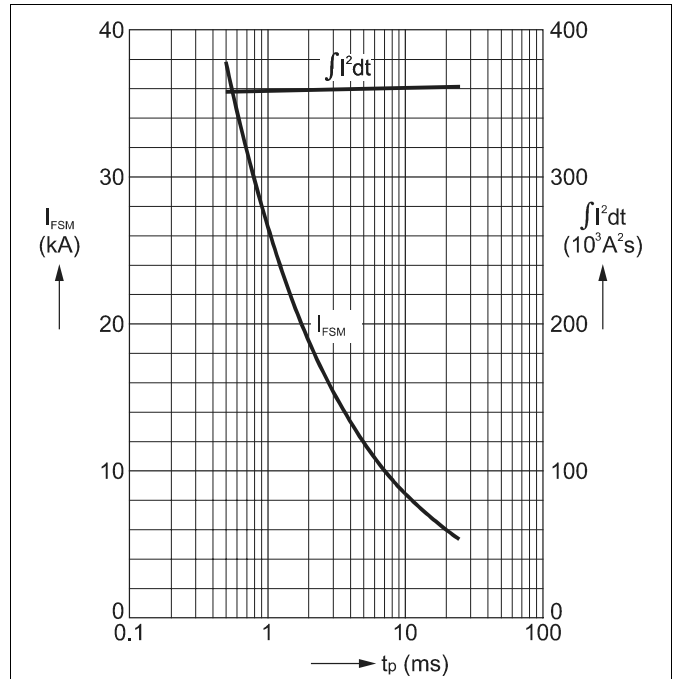

Fig. 2 Surge current and fusing integral vs. pulse width (max. values) for non-repetitive, half-sinusoidal surge current pulses.

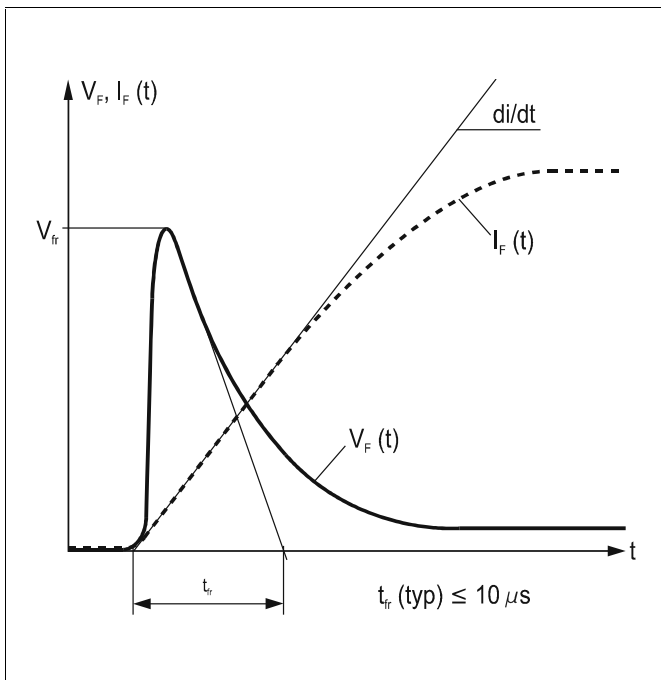

Fig. 3 Typical forward voltage waveform when the diode is turned on with a high di/dt.

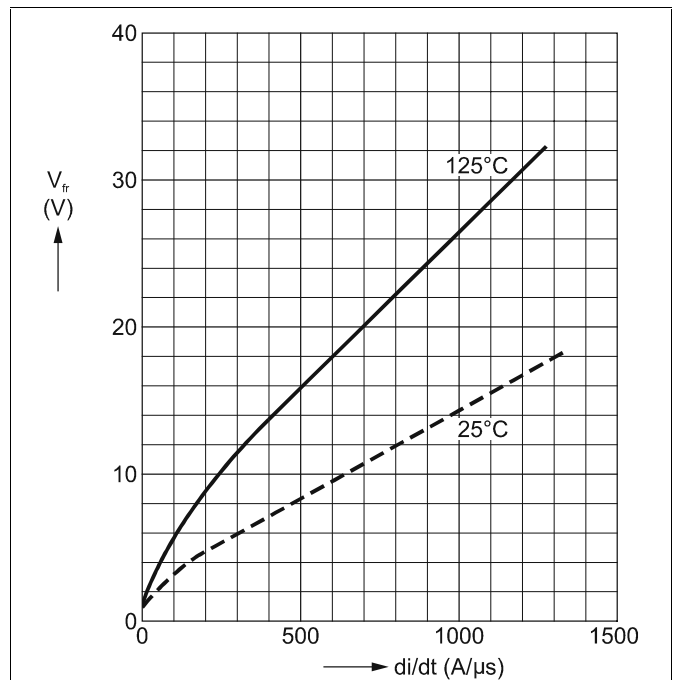

Fig. 4 Forward recovery voltage vs. turn-on di/dt (max. values).

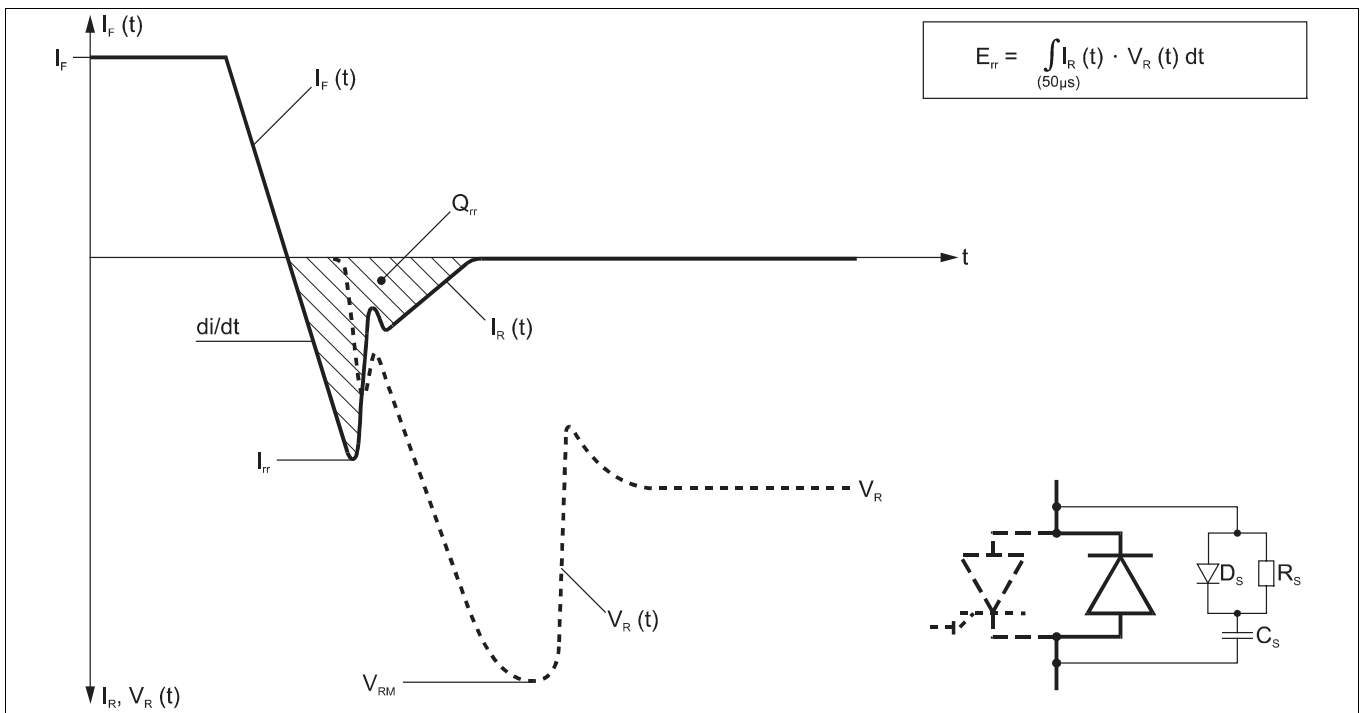

Fig. 5 Typical current and voltage waveforms at turn-off when the diode is connected to an RCD snubber, as often used in GTO circuits.

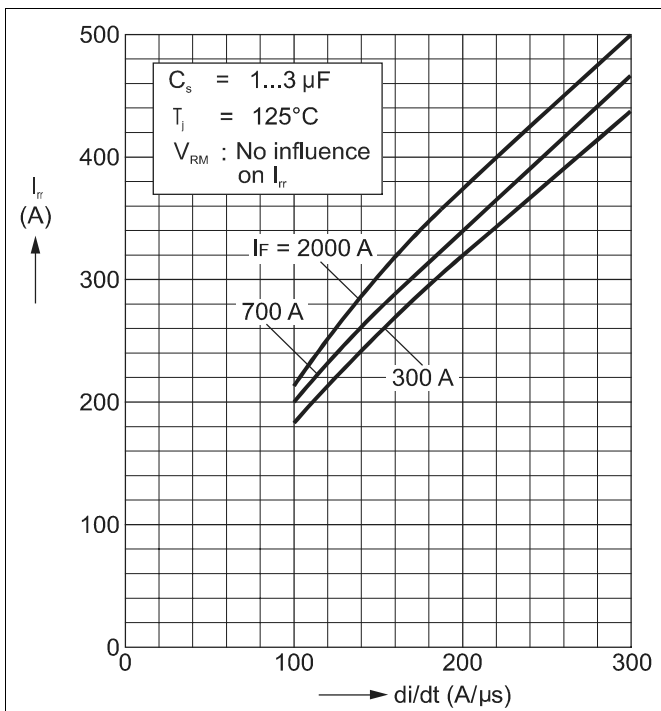

Fig. 6 Reverse recovery current vs. turn off di/dt (max. values).

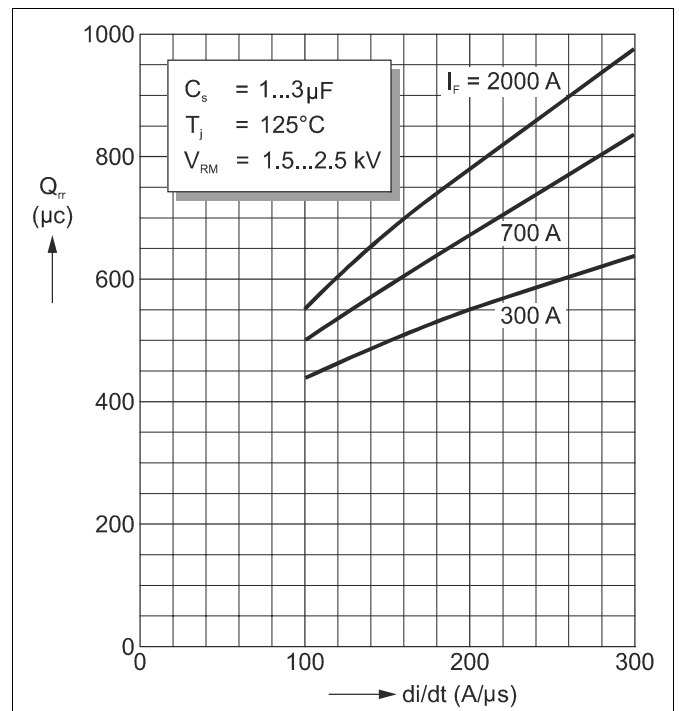

Fig. 7 Reverse recovery charge vs. turn off di/dt (max. values).

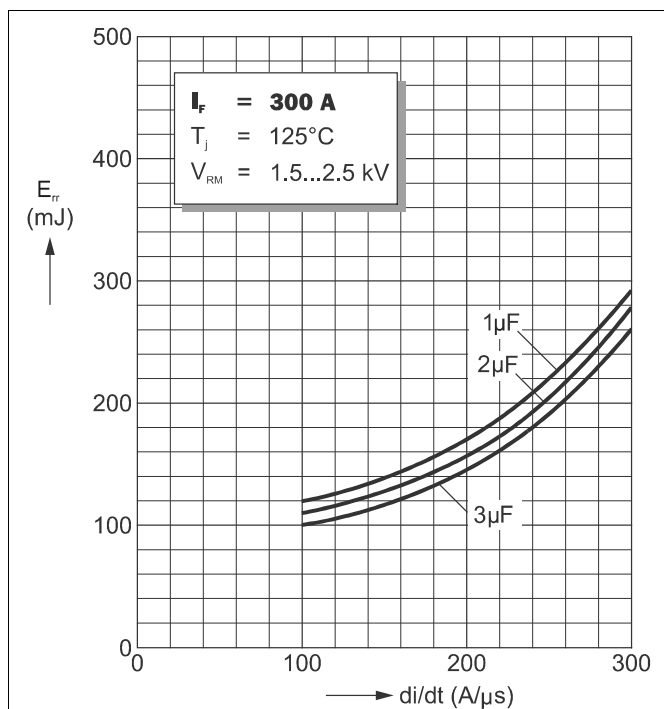

Fig. 8 Turn-off energy vs. turn-off di/dt for $I_F = 300$ A (max. values).

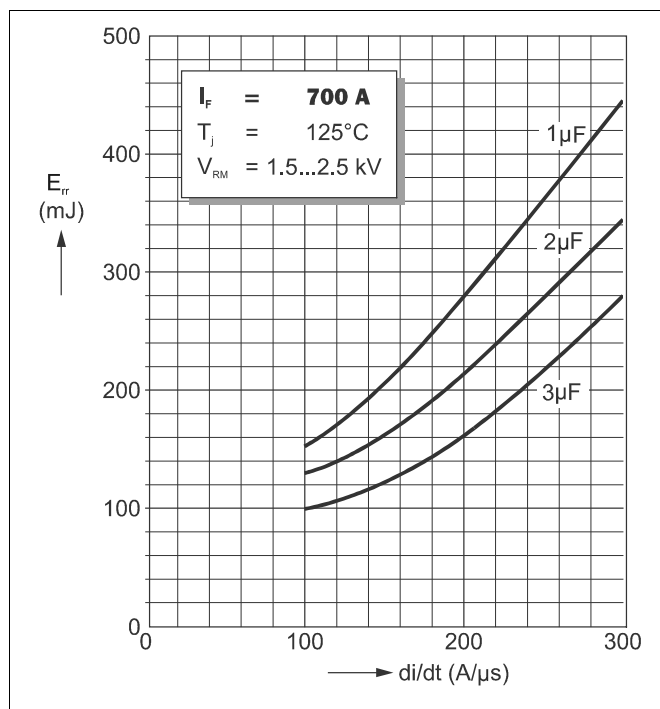

Fig. 9 Turn-off energy vs. turn-off di/dt for $I_F = 700$ A (max. values).

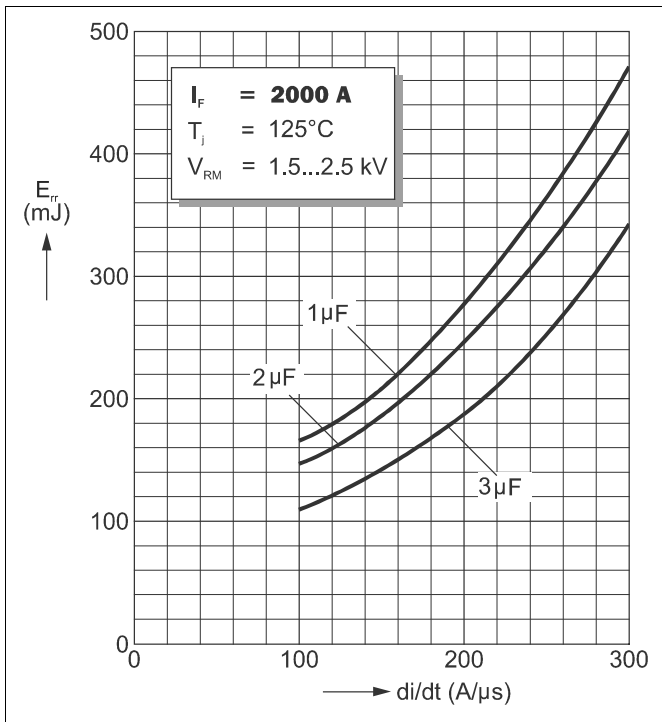

Fig. 10 Turn-off energy vs. turn-off di/dt for $I_F = 2000$ A (max. values).

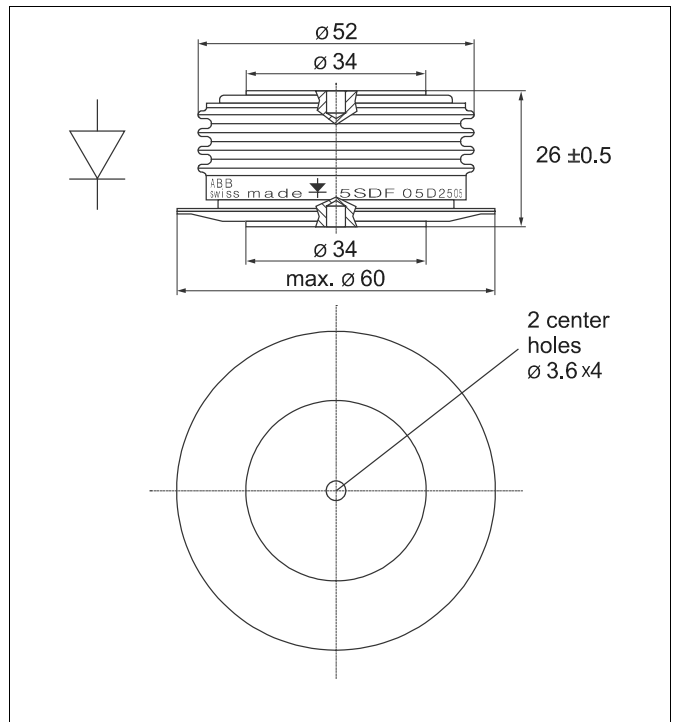

Fig. 11 Outline drawing. All dimensions are in millimeters and represent nominal values unless stated otherwise.

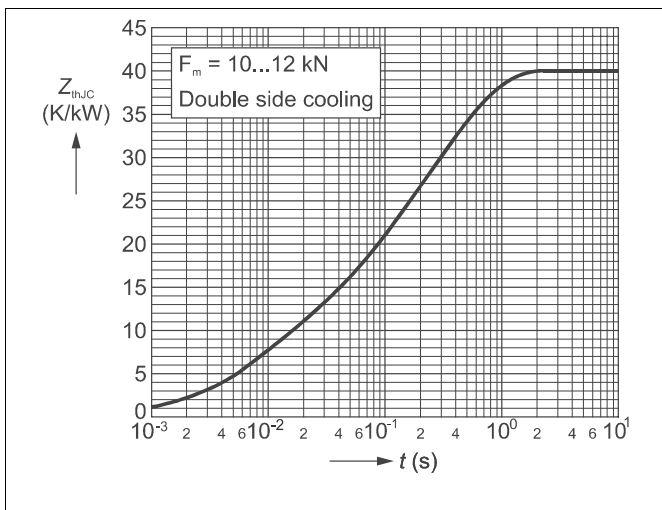

Fig. 12 Transient thermal impedance (junction-to-case) vs. time in analytical and graphical form (max. values).

$$Z_{thJC}(t) = \sum_{i=1}^4 R_i (1 - e^{-t/\tau_i})$$

i	1	2	3	4
R_i (K/kW)	20.95	10.57	7.15	1.33
τ_i (s)	0.396	0.072	0.009	0.0044

$F_m = 10... 12$ kN
Double side cooled

ABB Semiconductors AG reserves the right to change specifications without notice.



ABB Semiconductors AG
Fabrikstrasse 2
CH-5600 Lenzburg, Switzerland

Doc. No. 5SYA 1114-03 Aug. 2000

Tel: +41 (0)62 888 6419
Fax: +41 (0)62 888 6306
E-mail: info@ch.abb.com
Internet: www.abbsem.com