



# 5SDD 17F6000

Old part no. DV 818-1700-60

## High Voltage Diode

### Properties

- Low forward voltage drop
- Low recovery charge
- High operating temperature
- Low leakage current

### Key Parameters

$V_{RRM}$	=	6 000	V
$I_{FAVm}$	=	1 704	A
$I_{FSM}$	=	19 000	A
$V_{TO}$	=	0.894	V
$r_T$	=	0.344	mΩ

### Applications

- Rectifier bridges

### Types

	$V_{RRM}$
<b>5SDD 17F6000</b>	<b>6 000 V</b>
Conditions:	$T_j = -40 \div 150 \text{ }^\circ\text{C}$ , half sine waveform, $f = 50 \text{ Hz}$

### Mechanical Data

$F_m$	Mounting force	$22 \pm 2$	kN
$m$	Weight	0.46	kg
$D_s$	Surface cre page distance	30	mm
$D_a$	Air strike distance	20.5	mm

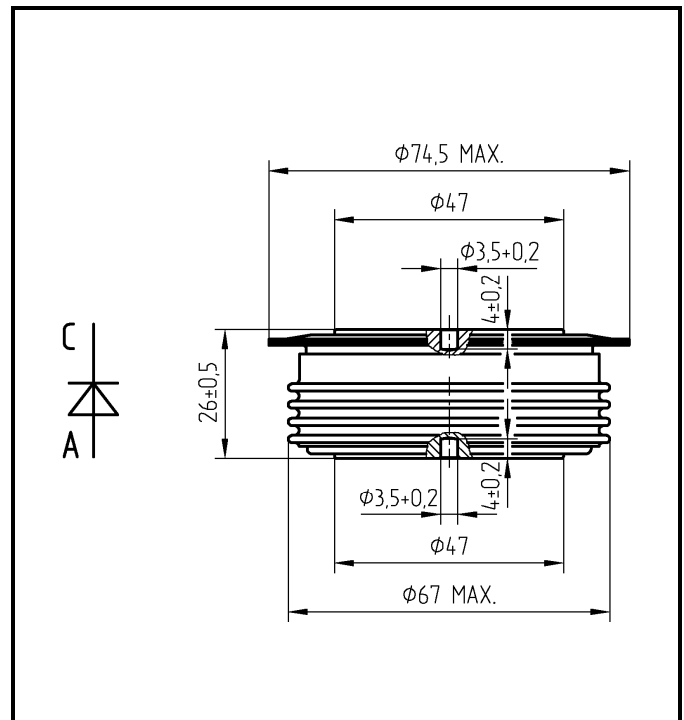

Fig. 1 Case



ABB s.r.o.

Novodvorska 1768/138a, 142 21 Praha 4, Czech Republic

tel.: +420 261 306 250, <http://www.abb.com/semiconductors>

<b>Maximum Ratings</b>		<b>Maximum Limits</b>	<b>Unit</b>	
$V_{RRM}$	<b>Repetitive peak reverse voltage</b> $T_j = -40 \div 150 \text{ }^\circ\text{C}$	<b>6 000</b>	<b>V</b>	
$I_{FAVm}$	<b>Average forward current</b> $T_c = 85 \text{ }^\circ\text{C}$	<b>1 704</b>	<b>A</b>	
$I_{FRMS}$	<b>RMS forward current</b> $T_c = 85 \text{ }^\circ\text{C}$	<b>2 677</b>	<b>A</b>	
$I_{RRM}$	<b>Repetitive reverse current</b> $V_R = V_{RRM}$	<b>75</b>	<b>mA</b>	
$I_{FSM}$	<b>Non repetitive peak surge current</b> $V_R = 0 \text{ V, half sine pulse}$	$t_p = 8.3 \text{ ms}$	<b>20 300</b>	<b>A</b>
		$t_p = 10 \text{ ms}$	<b>19 000</b>	<b>A</b>
$I^2t$	<b>Limiting load integral</b> $V_R = 0 \text{ V, half sine pulse}$	$t_p = 8.3 \text{ ms}$	<b>1 710 000</b>	<b>A<sup>2</sup>s</b>
		$t_p = 10 \text{ ms}$	<b>1 805 000</b>	<b>A<sup>2</sup>s</b>
$T_{jmin} - T_{jmax}$	<b>Operating temperature range</b>	<b>-40 <math>\div</math> 150</b>	<b><math>^\circ\text{C}</math></b>	
$T_{STG}$	<b>Storage temperature range</b>	<b>-40 <math>\div</math> 150</b>	<b><math>^\circ\text{C}</math></b>	

Unless otherwise specified  $T_j = 150 \text{ }^\circ\text{C}$

<b>Characteristics</b>		<b>Value</b>			<b>Unit</b>
		<i>min</i>	<i>typ</i>	<i>max</i>	
$V_{T0}$	<b>Threshold voltage</b>			<b>0.894</b>	<b>V</b>
$r_T$	<b>Forward slope resistance</b> $I_{F1} = 2\,670 \text{ A, } I_{F2} = 8\,011 \text{ A}$			<b>0.344</b>	<b>m<math>\Omega</math></b>
$V_{FM}$	<b>Maximum forward voltage</b> $I_{FM} = 4\,000 \text{ A}$			<b>2.280</b>	<b>V</b>
$Q_{rr}$	<b>Recovered charge</b> $V_R = 100 \text{ V, } I_{FM} = 2000 \text{ A, } di_F/dt = -30 \text{ A}/\mu\text{s}$		<b>5 200</b>		<b><math>\mu\text{C}</math></b>

Unless otherwise specified  $T_j = 150 \text{ }^\circ\text{C}$

Thermal Parameters			Value	Unit
$R_{thjc}$	Thermal resistance junction to case	double side cooling	15	K/kW
		anode side cooling	24	
		cathode side cooling	40	
$R_{thch}$	Thermal resistance case to heatsink	double side cooling	4	K/kW
		single side cooling	8	

**Transient Thermal Impedance**

Analytical function for transient thermal impedance

$$Z_{thjc} = \sum_{i=1}^5 R_i (1 - \exp(-t / \tau_i))$$

Conditions:

$F_m = 22 \pm 2$  kN, Double side cooled

**Correction for periodic waveforms**

180° sine:	1.3 K/kW
180° rectangular:	1.7 K/kW
120° rectangular:	2.9 K/kW
60° rectangular:	4.8 K/kW

$i$	1	2	3	4	5
$\tau_i$ (s)	0.6937	0.2040	0.0452	0.0040	0.0005
$R_i$ (K/kW)	6.04	3.83	3.76	1.31	0.07

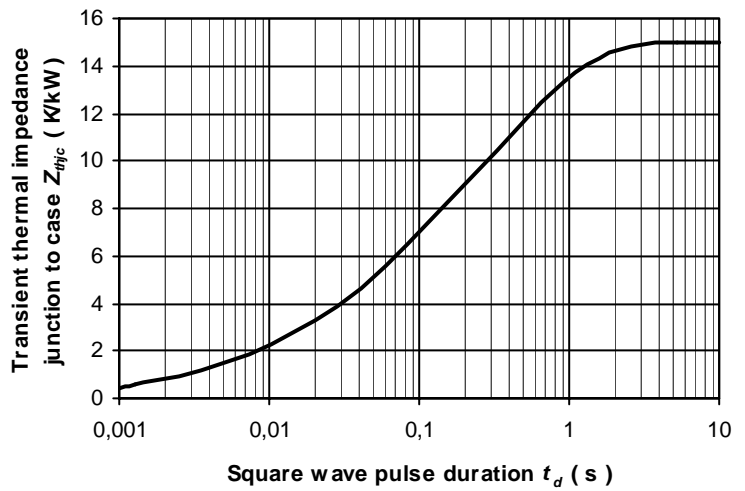

Fig. 2 Dependence transient thermal impedance junction to case on square pulse

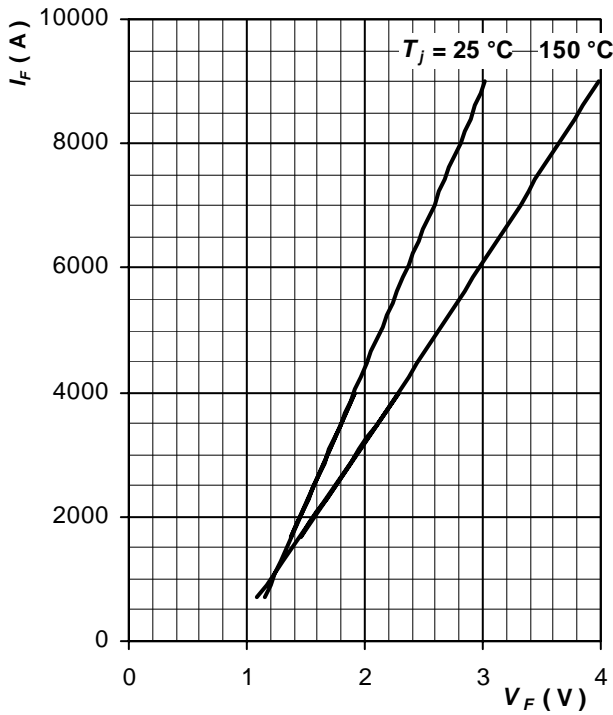

Fig. 3 Maximum forward voltage drop characteristics

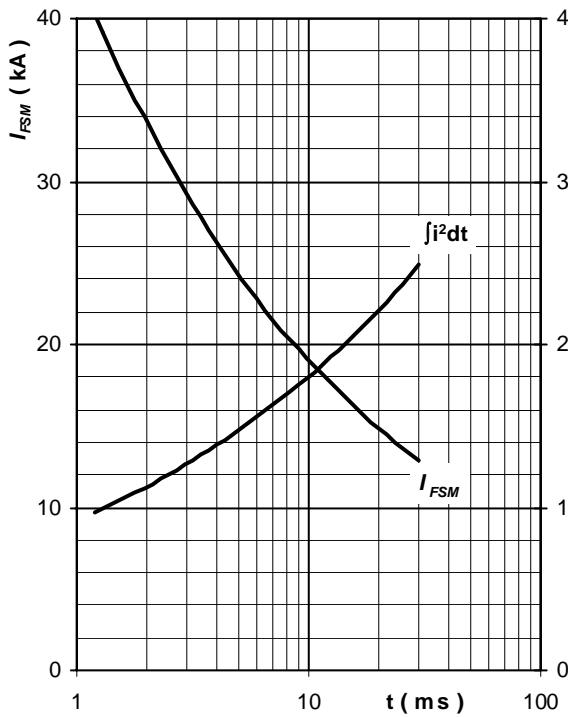

Fig. 4 Surge forward current vs. pulse length, half sine wave, single pulse,  $V_R = 0\text{ V}$ ,  $T_j = T_{jmax}$

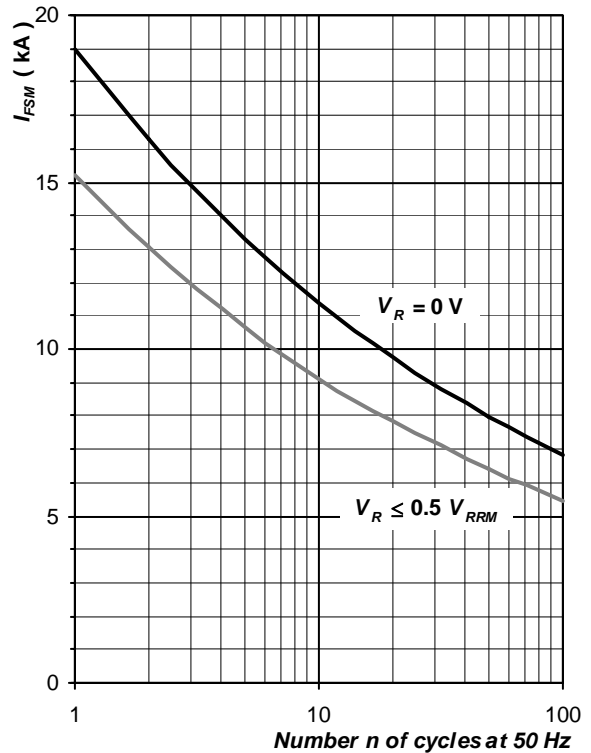

Fig. 5 Surge forward current vs. number of pulses, half sine wave,  $T_j = T_{jmax}$

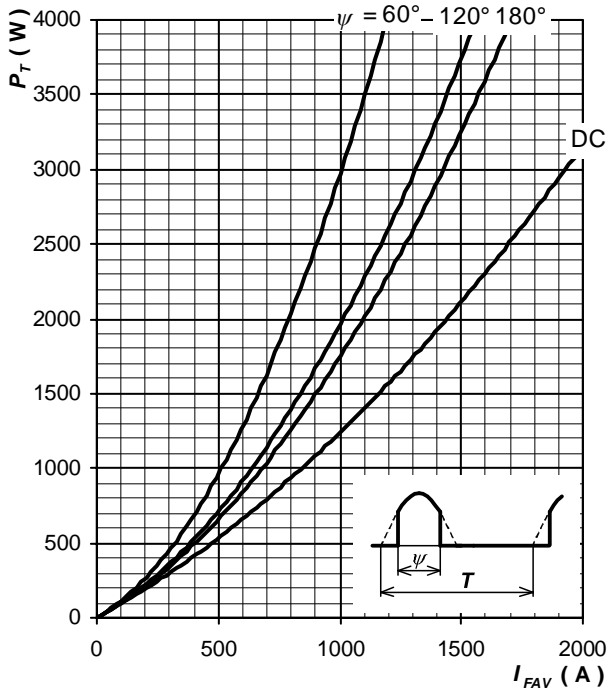

Fig. 6 Forward power loss vs. average forward current, sine waveform,  $f = 50 \text{ Hz}$ ,  $T = 1/f$

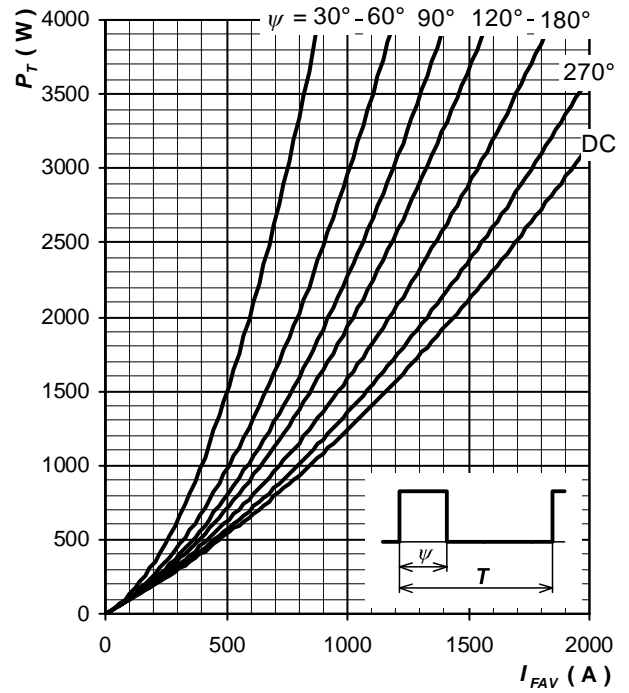

Fig. 7 Forward power loss vs. average forward current, square waveform,  $f = 50 \text{ Hz}$ ,  $T = 1/f$

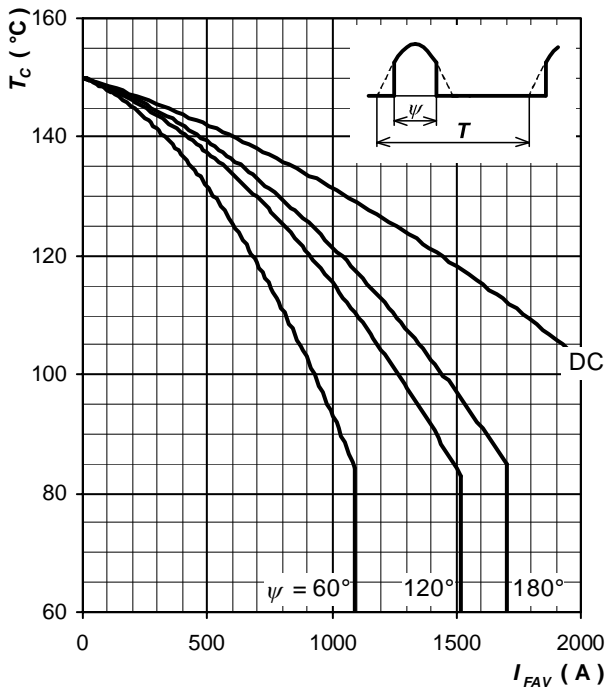

Fig. 8 Max. case temperature vs. aver. forward current, sine waveform,  $f = 50 \text{ Hz}$ ,  $T = 1/f$

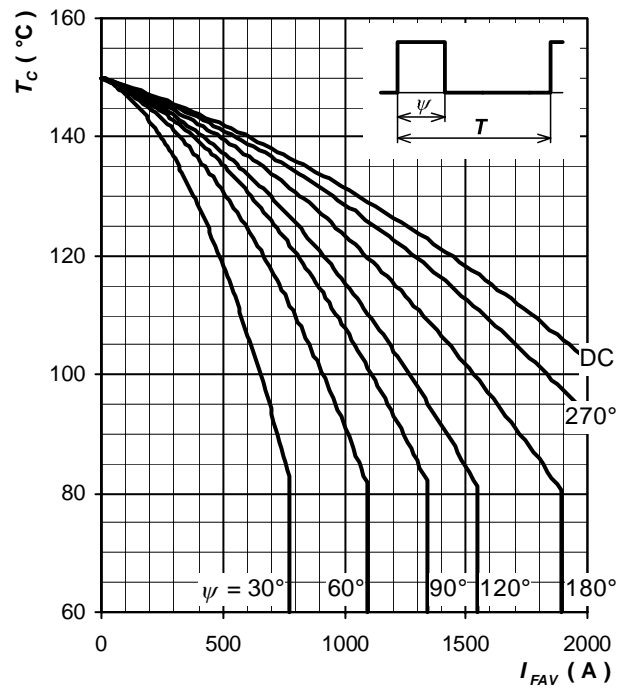

Fig. 9 Max. case temperature vs. aver. forward current, square waveform,  $f = 50 \text{ Hz}$ ,  $T = 1/f$

Notes: