



# 5SDD 08D5000

Old part no. DV 827-800-50

## Rectifier Diode

### Properties

- low forward voltage drop
- low recovery charge
- high operating temperature
- low leakage current

### Applications

- Rectifier bridges

### Key Parameters

$V_{RRM}$	=	5 000	V
$I_{FAVm}$	=	1 028	A
$I_{FSM}$	=	12 000	A
$V_{TO}$	=	0.894	V
$r_T$	=	0.487	m $\Omega$

### Types

	$V_{RRM}$
<b>5SDD 08D5000</b>	<b>5 000 V</b>
Conditions:	$T_j = -40 \div 160 \text{ }^\circ\text{C}$ , half sine waveform, $f = 50 \text{ Hz}$

### Mechanical Data

$F_m$	Mounting force	$10 \pm 2 \text{ kN}$
$m$	Weight	<b>0.27 kg</b>
$D_s$	Surface creepage distance	<b>30 mm</b>
$D_a$	Air strike distance	<b>20 mm</b>

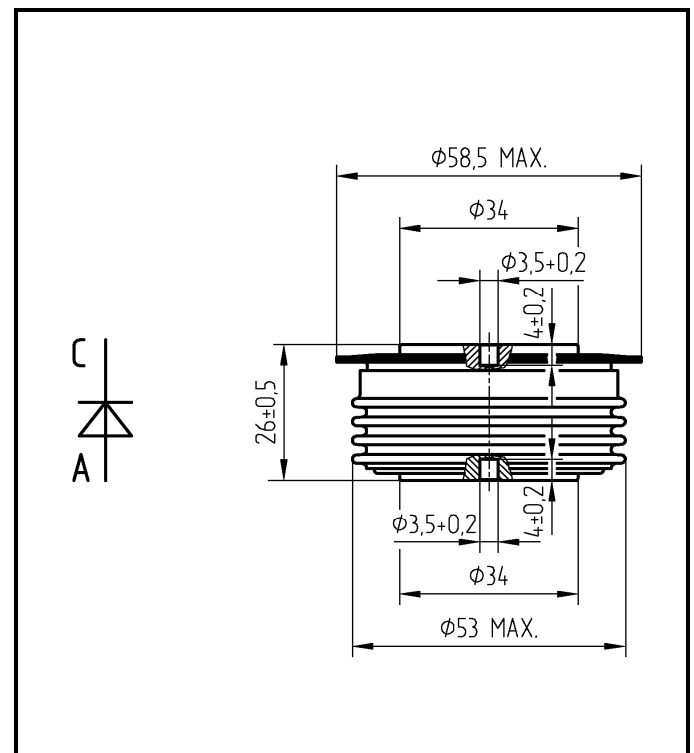

Fig. 1 Case



ABB s.r.o.

Novodvorska 1768/138a, 142 21 Praha 4, Czech Republic

tel.: +420 261 306 250, <http://www.abb.com/semiconductors>

<b>Maximum Ratings</b>		<b>Maximum Limits</b>	<b>Unit</b>	
$V_{RRM}$	<b>Repetitive peak reverse voltage</b> $T_j = -40 \div 160 \text{ }^\circ\text{C}$	<b>5 000</b>	<b>V</b>	
$I_{FAVm}$	<b>Average forward current</b> $T_c = 85 \text{ }^\circ\text{C}$	<b>1 028</b>	<b>A</b>	
$I_{FRMS}$	<b>RMS forward current</b> $T_c = 85 \text{ }^\circ\text{C}$	<b>1 614</b>	<b>A</b>	
$I_{RRM}$	<b>Repetitive reverse current</b> $V_R = V_{RRM}$	<b>30</b>	<b>mA</b>	
$I_{FSM}$	<b>Non repetitive peak surge current</b> $V_R = 0 \text{ V, half sine pulse, } T_j = 25 \text{ }^\circ\text{C}$	$t_p = 8.3 \text{ ms}$	<b>16 000</b>	<b>A</b>
		$t_p = 10 \text{ ms}$	<b>15 000</b>	<b>A</b>
	<b>Non repetitive peak surge current</b> $V_R = 0 \text{ V, half sine pulse}$	$t_p = 8.3 \text{ ms}$	<b>12 800</b>	<b>A</b>
		$t_p = 10 \text{ ms}$	<b>12 000</b>	<b>A</b>
$\int I^2 dt$	<b>Limiting load integral</b> $V_R = 0 \text{ V, half sine pulse, } T_j = 25 \text{ }^\circ\text{C}$	$t_p = 8.3 \text{ ms}$	<b>1 066 000</b>	<b>A<sup>2</sup>s</b>
		$t_p = 10 \text{ ms}$	<b>1 125 000</b>	<b>A<sup>2</sup>s</b>
	<b>Limiting load integral</b> $V_R = 0 \text{ V, half sine pulse}$	$t_p = 8.3 \text{ ms}$	<b>682 000</b>	<b>A<sup>2</sup>s</b>
		$t_p = 10 \text{ ms}$	<b>720 000</b>	<b>A<sup>2</sup>s</b>
$T_{jmin} - T_{jmax}$	<b>Operating temperature range</b>	<b>-40 <math>\div</math> 160</b>	<b>°C</b>	
$T_{STG}$	<b>Storage temperature range</b>	<b>-40 <math>\div</math> 160</b>	<b>°C</b>	

Unless otherwise specified  $T_j = 160 \text{ }^\circ\text{C}$

<b>Characteristics</b>		<b>Value</b>			<b>Unit</b>
		<i>min</i>	<i>typ</i>	<i>max</i>	
$V_{T0}$	<b>Threshold voltage</b>			<b>0.894</b>	<b>V</b>
$r_T$	<b>Forward slope resistance</b> $I_{F1} = 1\,500 \text{ A, } I_{F2} = 4\,500 \text{ A}$			<b>0.487</b>	<b>mΩ</b>
$V_{FM}$	<b>Maximum forward voltage</b> $I_{FM} = 1\,500 \text{ A}$			<b>1.65</b>	<b>V</b>
$Q_{rr}$	<b>Recovered charge</b> $V_R = 100 \text{ V, } I_{FM} = 1\,000 \text{ A, } di/dt = -30 \text{ A}/\mu\text{s}$		<b>2 400</b>	<b>3 500</b>	<b>μC</b>

Unless otherwise specified  $T_j = 160 \text{ }^\circ\text{C}$

Thermal Parameters			Value	Unit
$R_{thjc}$	Thermal resistance junction to case	double side cooling	32	K/kW
		anode side cooling	50	
		cathode side cooling	88	
$R_{thch}$	Thermal resistance case to heatsink	double side cooling	8	K/kW
		single side cooling	16	

Transient Thermal Impedance													
Analytical function for transient thermal impedance  $Z_{thjc} = \sum_{i=1}^5 R_i (1 - \exp(-t / \tau_i))$	$i$	1	2	3	4	5							
	$\tau_i$ (s)	0.7033	0.2185	0.0588	0.0042	0.0006							
	$R_i$ (K/kW)	11.56	10.08	7.84	2.38	0.13							
Conditions: $F_m = 10 \pm 2$ kN, Double side cooled  Correction for periodic waveforms													
<table border="1"> <tbody> <tr> <td>180° sine:</td> <td>2.3 K/kW</td> </tr> <tr> <td>180° rectangular:</td> <td>3.1 K/kW</td> </tr> <tr> <td>120° rectangular:</td> <td>5.1 K/kW</td> </tr> <tr> <td>60° rectangular:</td> <td>8.7 K/kW</td> </tr> </tbody> </table>	180° sine:	2.3 K/kW	180° rectangular:	3.1 K/kW	120° rectangular:	5.1 K/kW	60° rectangular:	8.7 K/kW	Fig. 2 Dependence transient thermal impedance junction to case on square pulse				
180° sine:	2.3 K/kW												
180° rectangular:	3.1 K/kW												
120° rectangular:	5.1 K/kW												
60° rectangular:	8.7 K/kW												

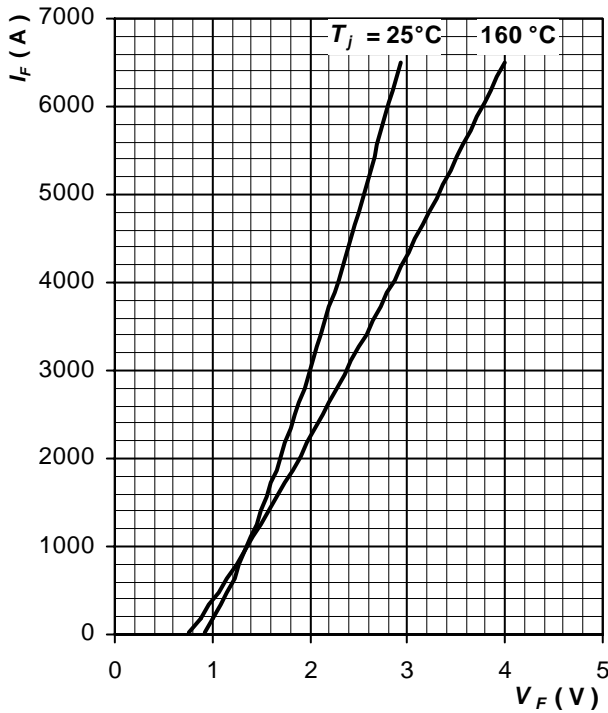

Fig. 3 Maximum forward voltage drop characteristics

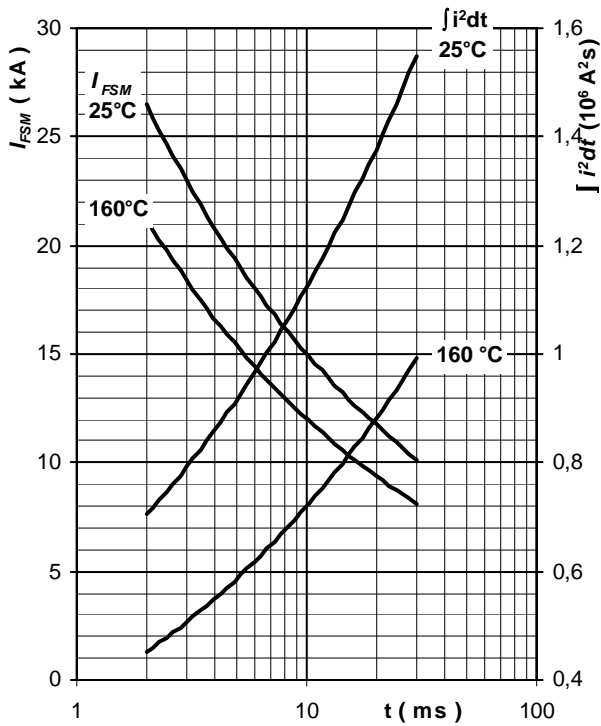

Fig. 4 Surge forward current vs. pulse length, half sine wave, single pulse,  $V_R = 0 \text{ V}$

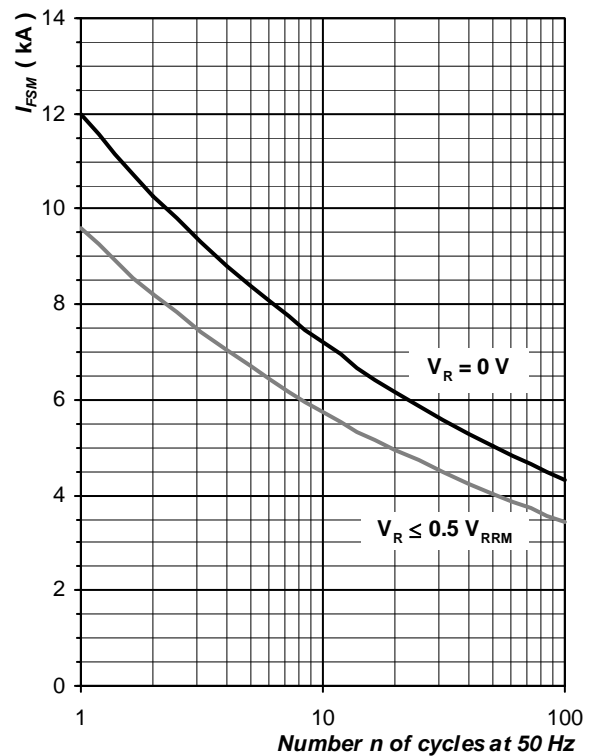

Fig. 5 Surge forward current vs. number of pulses, half sine wave,  $T_j = T_{jmax}$

ABB s.r.o., Novodvorska 1768/138a, 142 21 Praha 4, Czech Republic

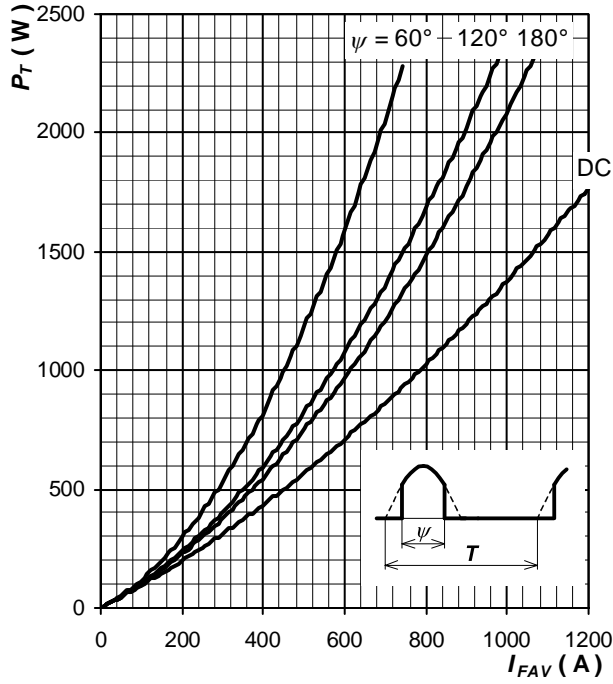

Fig. 6 Forward power loss vs. average forward current, sine waveform,  $f = 50 \text{ Hz}$ ,  $T = 1/f$

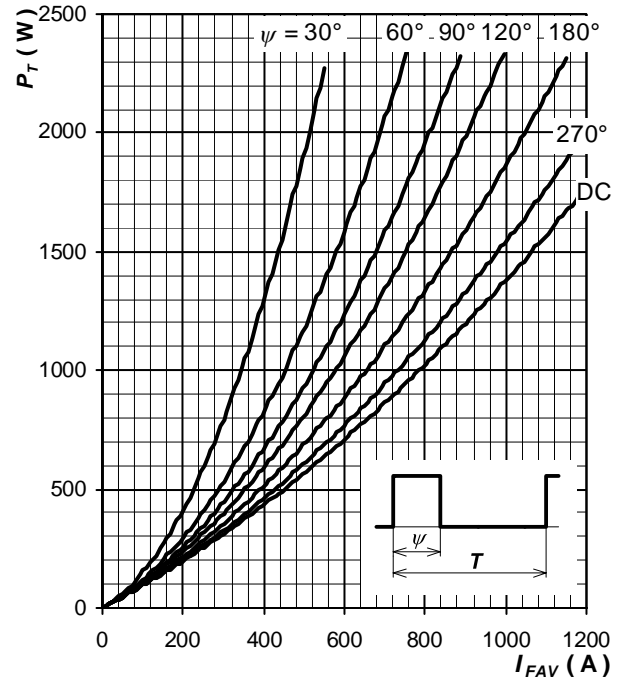

Fig. 7 Forward power loss vs. average forward current, square waveform,  $f = 50 \text{ Hz}$ ,  $T = 1/f$

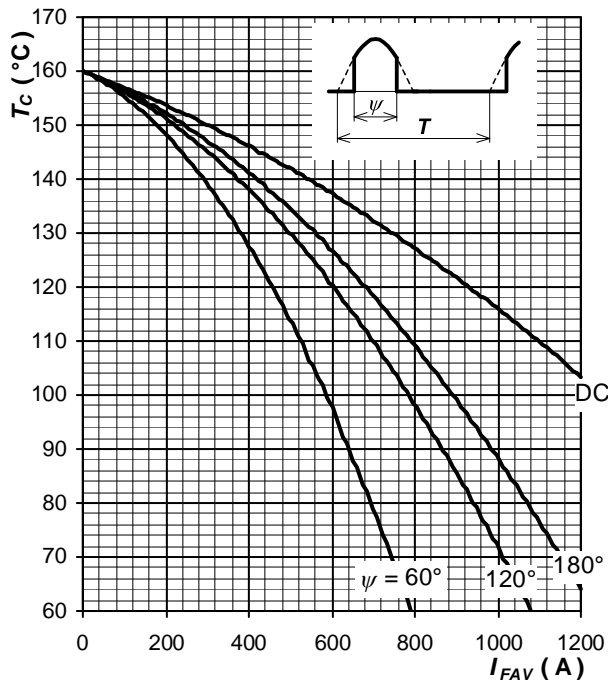

Fig. 8 Max. case temperature vs. aver. forward current, sine waveform,  $f = 50 \text{ Hz}$ ,  $T = 1/f$

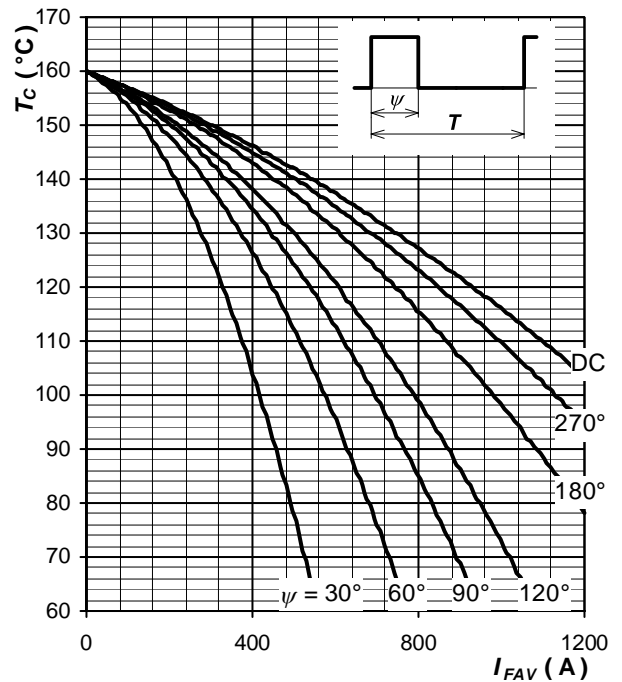

Fig. 9 Max. case temperature vs. aver. forward current, square waveform,  $f = 50 \text{ Hz}$ ,  $T = 1/f$

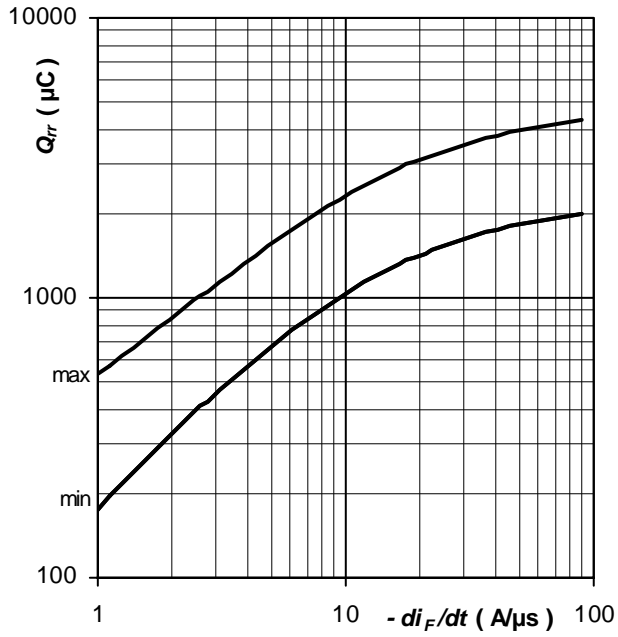

Fig. 10 Recovered charge  $Q_{rr}$   
vs. rate of fall forward current  $di_F/dt$ ,  
trapezoid pulse,  $I_{FM} = 1\,000\text{ A}$ ,  
 $V_R = 100\text{ V}$ ,  $T_j = T_{jmax}$

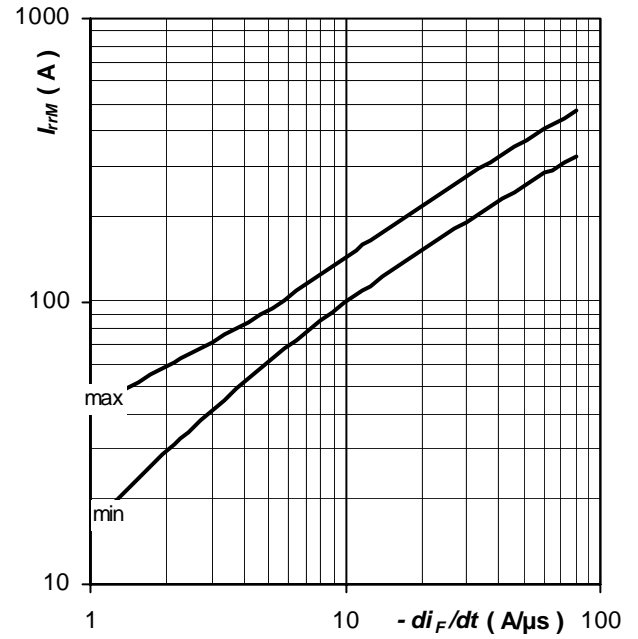

Fig. 11 Reverse recovery maximum current  $I_{rrM}$   
vs. rate of fall forward current  $di_F/dt$ ,  
trapezoid pulse,  $I_{FM} = 1\,000\text{ A}$ ,  
 $V_R = 100\text{ V}$ ,  $T_j = T_{jmax}$

Notes: