



5SDD 0120C0200

Old part no. DS 879D-12000-02

Welding diode

Properties

- High forward current capability
- Low forward and reverse recovery losses
- High operational reliability

Applications

- Welding equipment
- High current application up to 2000 Hz

Key parameters

V_{RRM}	=	200	V
I_{FAVm}	=	11 000	A
I_{FSM}	=	85 000	A
V_{TO}	=	0.75	V
r_T	=	0.020	m Ω

Types

type	V_{RRM}
5SDD 0120C0200	200 V
Conditions: $T_j = -40 \div 170$ °C, half sine waveform, $f = 50$ Hz	

Mechanical data

F_m	Mounting force	35 ÷ 40 kN
m	Weight	0.22 kg
D_s	Surface creepage distance	4 mm
D_a	Air strike distance	4 mm

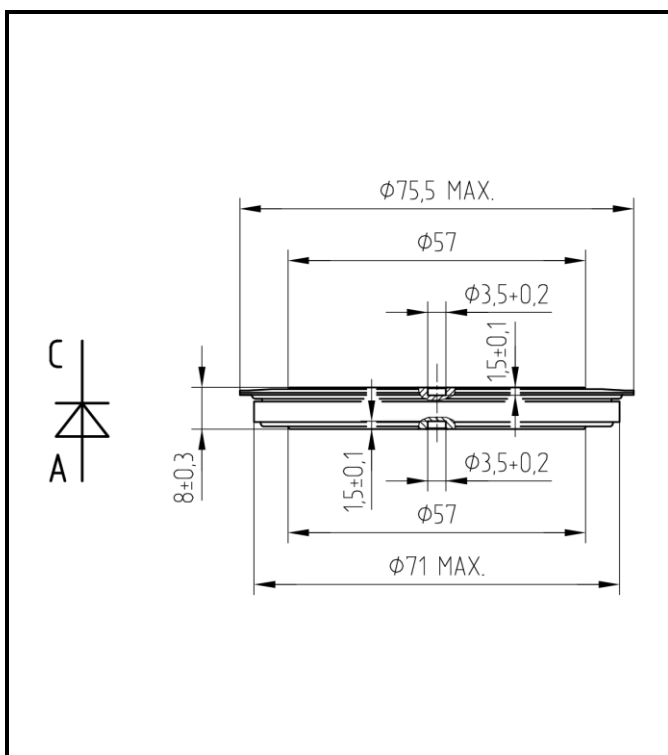

Fig. 1 Case



ABB s.r.o.

Novodvorska 1768/138a, 142 21 Praha 4, Czech Republic

tel.: +420 261 306 250, <http://www.abb.com/semiconductors>

Maximum Ratings		Maximum Limits	Unit
V_{RRM}	Repetitive peak reverse voltage $T_j = -40 \div 170 \text{ }^\circ\text{C}$	200	V
I_{FAVm}	Average forward current $T_c = 85 \text{ }^\circ\text{C}$	11 000	A
I_{FRMS}	RMS forward current $T_c = 85 \text{ }^\circ\text{C}$	17 300	A
I_R	Repetitive reverse current $V_R = V_{RRM}$	50	mA
I_{FSM}	Nonrepetitive peak surge current $t_p = 10 \text{ ms}, V_R = 0 \text{ V}, \text{ half sine pulse}$	85 000	A
I^2t	Limiting load integral $t_p = 10 \text{ ms}, V_R = 0 \text{ V}, \text{ half sine pulse}$	36 000 000	A²s
$T_{jmin} - T_{jmax}$	Operating temperature range	- 40 \div 170	$^\circ\text{C}$
$T_{stgmin} - T_{stgmax}$	Storage temperature range	- 40 \div 170	$^\circ\text{C}$

Unless otherwise specified $T_j = 170 \text{ }^\circ\text{C}$

Characteristics		Value			Unit
		<i>min</i>	<i>typ</i>	<i>max</i>	
V_{T0}	Threshold voltage			0.750	V
r_T	Forward slope resistance $I_{F1} = 8\,000 \text{ A}, I_{F2} = 18\,000 \text{ A}$			0.020	mΩ
V_{FM}	Maximum forward voltage $I_{FM} = 8000 \text{ A}$			0.92	V
Q_{rr}	Recovered charge $I_{FM} = 1000 \text{ A}, di/dt = -30 \text{ A}/\mu\text{s}, V_R = 50 \text{ V}$		350		μC

Unless otherwise specified $T_j = 170 \text{ }^\circ\text{C}$

Thermal Specifications			Value	Unit
R_{thjc}	Thermal resistance junction to case	<i>double side cooling</i>	6	K/kW
		<i>single side cooling</i>	12	
R_{thch}	Thermal resistance case to heatsink	<i>double side cooling</i>	3	K/kW
		<i>single side cooling</i>	6	

ABB s.r.o., Novodvorska 1768/138a, 142 21 Praha 4, Czech Republic

Analytical function for transient thermal impedance

$$Z_{thjc} = \sum_{i=1}^4 R_i (1 - \exp(-t / \tau_i))$$

Conditions:
 $F_m = 35 \div 40$ kN, Double side cooled

i	1	2	3	4
R_i (K/kW)	4.6507	0.8219	0.4408	0.0870
τ_i (s)	0.0830	0.0172	0.0040	0.0002

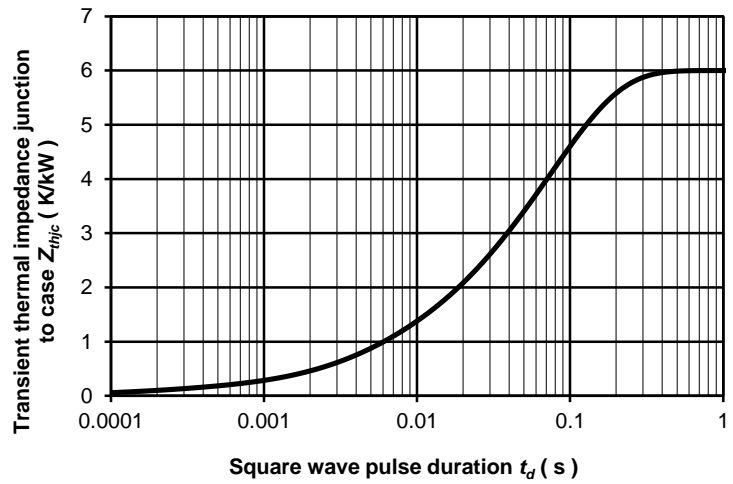

Fig. 2 Dependence transient thermal impedance junction to case on square pulse

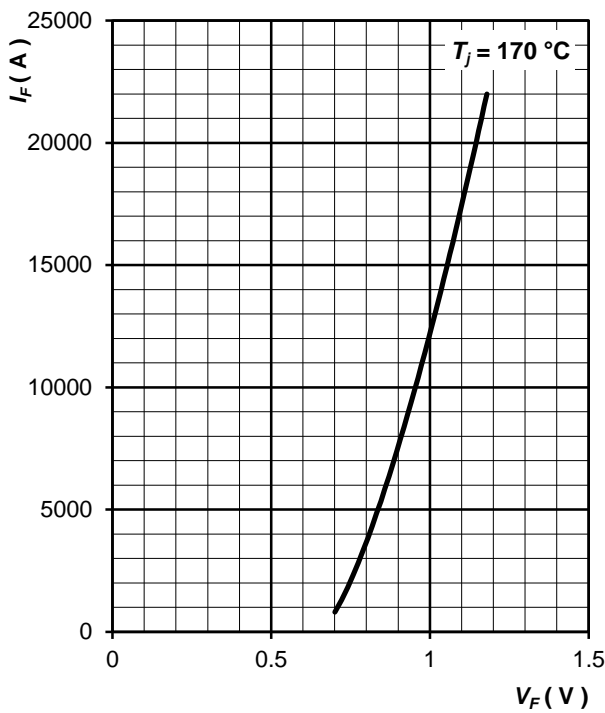

Fig. 3 Maximum forward voltage drop characteristics

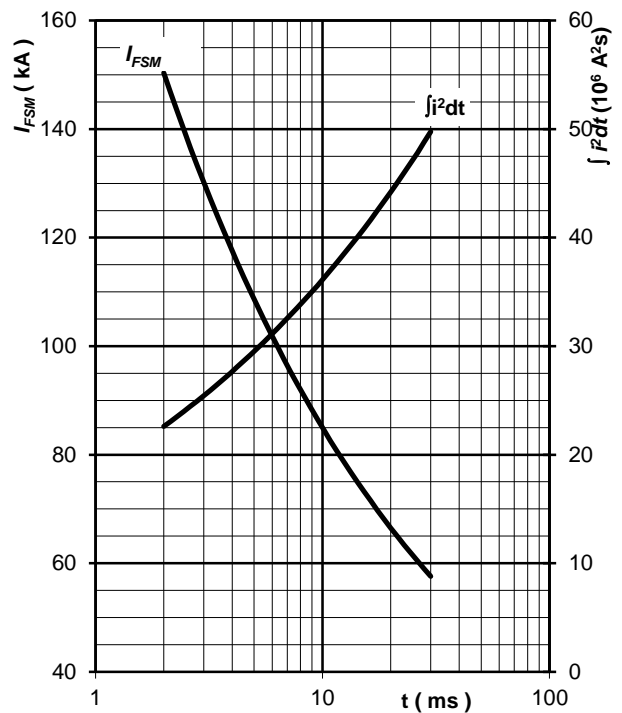

Fig. 4 Surge forward current vs. pulse length, half sine wave, single pulse, $V_R = 0$ V, $T_j = T_{jmax}$

ABB s.r.o., Novodvorska 1768/138a, 142 21 Praha 4, Czech Republic

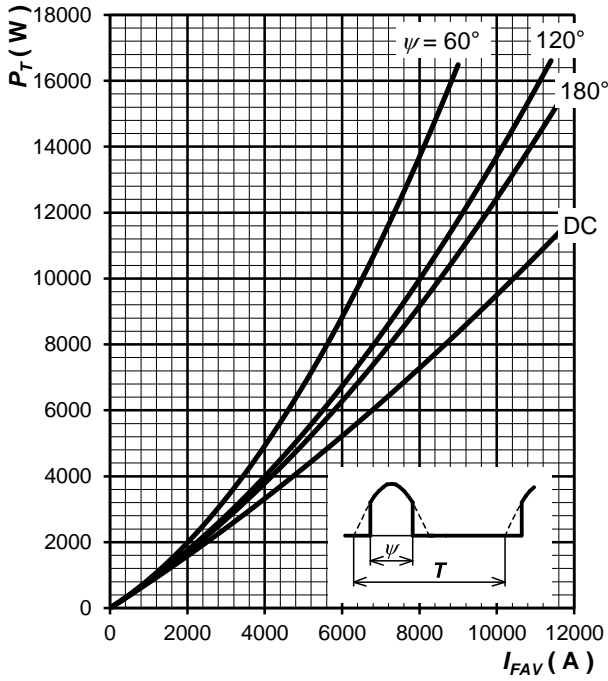

Fig. 5 Forward power loss vs. average forward current, sine waveform, $f = 50$ Hz

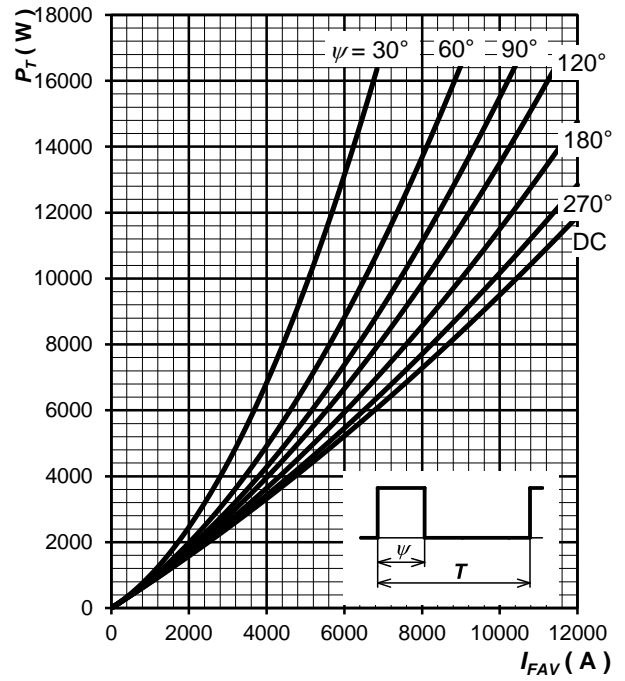

Fig. 6 Forward power loss vs. average forward current, square waveform, $f = 50$ Hz

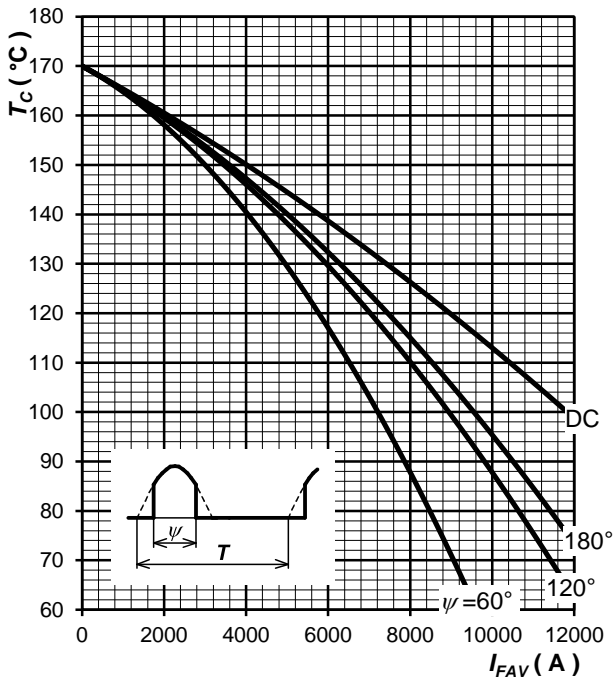

Fig. 7 Max. case temperature vs. aver. forward current, sine waveform, $f = 50$ Hz

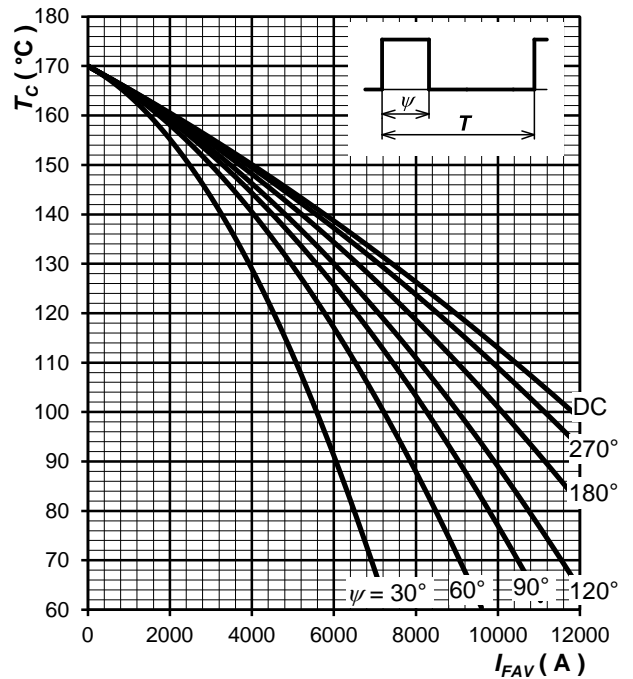

Fig. 8 Max. case temperature vs. aver. forward current, square waveform, $f = 50$ Hz

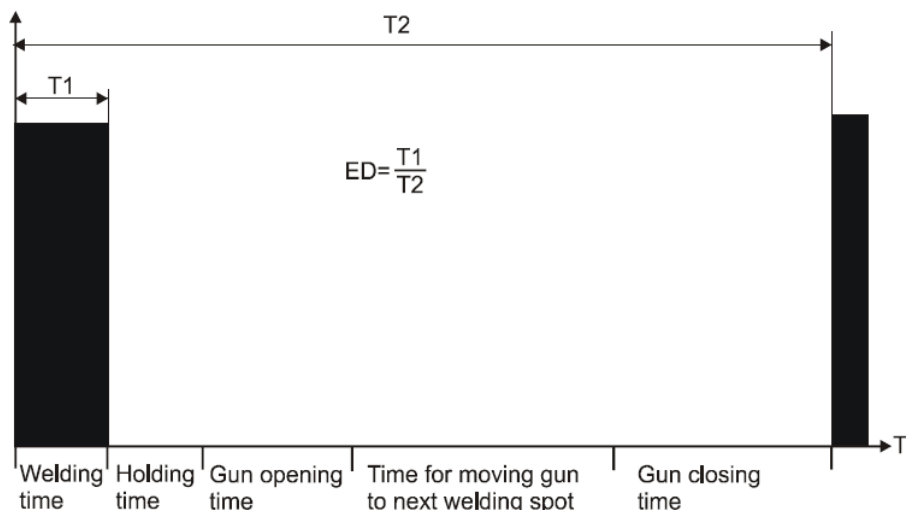

Fig. 9 Definition of ED for typical welding sequence

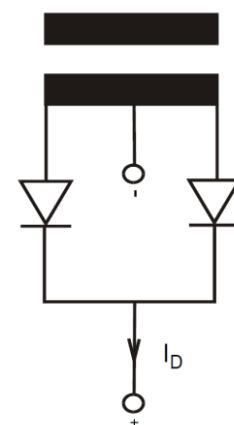

Fig. 10 Definition of I_D for single-phase centre tap

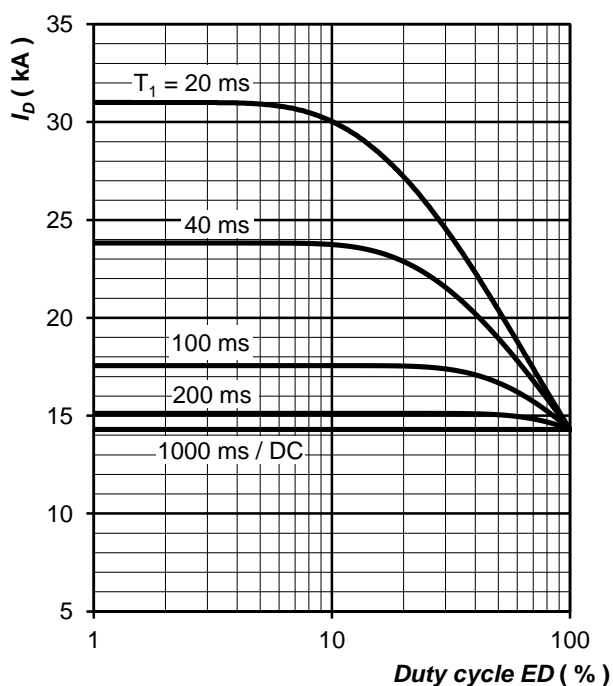

Fig. 11 Current load capacity, cont.,
DC output welding current with single-phase centre tap vs. duty cycle
 $f = 1000 \text{ Hz}$, square wave, $\Delta T_j = 80 \text{ }^\circ\text{C}$

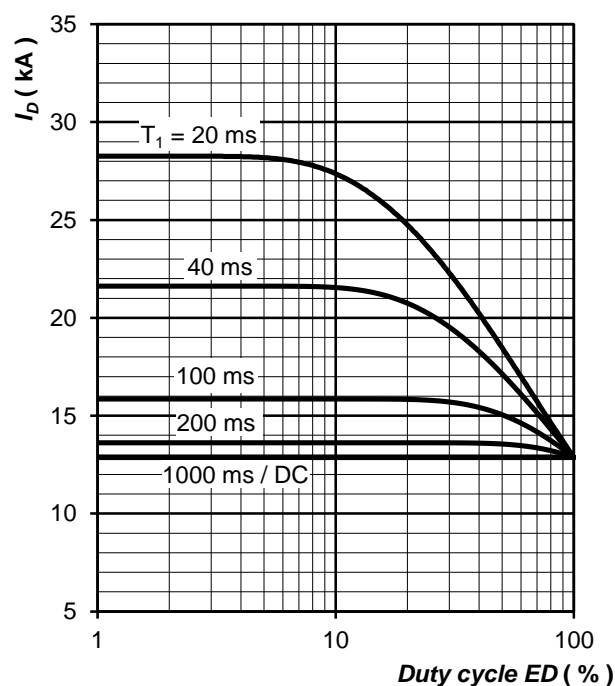

Fig. 12 Current load capacity, cont.,
DC output welding current with single-phase centre tap vs. duty cycle
 $f = 1000 \text{ Hz}$, square wave, $\Delta T_j = 70 \text{ }^\circ\text{C}$

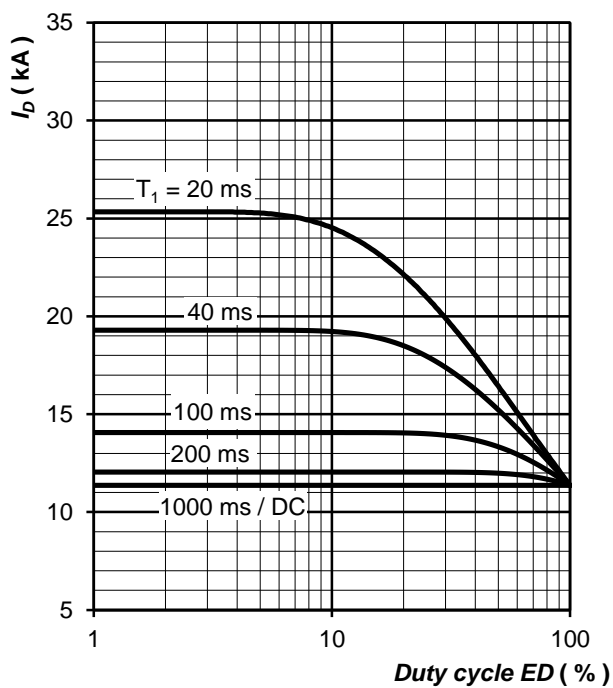

Fig. 13 Current load capacity, cont.,
DC output welding current with single-phase
centre tap vs. duty cycle
 $f = 1000 \text{ Hz}$, square wave, $\Delta T_j = 60 \text{ }^\circ\text{C}$

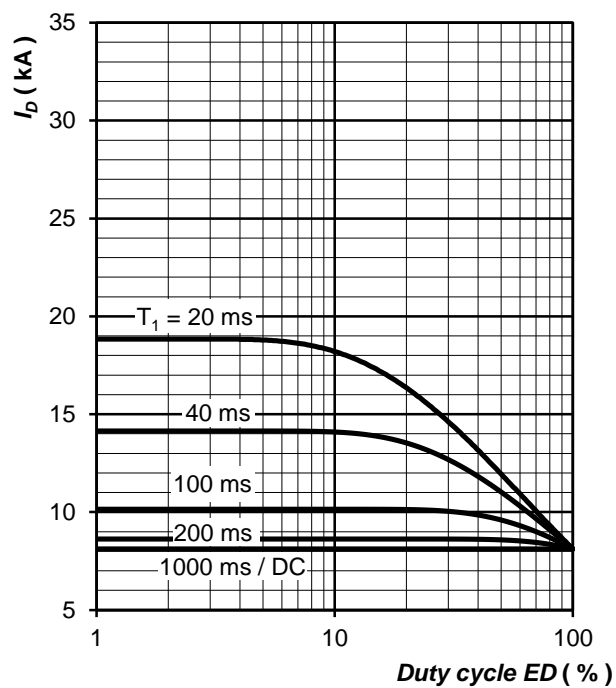

Fig. 14 Current load capacity, cont.,
DC output welding current with single-phase
centre tap vs. duty cycle
 $f = 1000 \text{ Hz}$, square wave, $\Delta T_j = 40 \text{ }^\circ\text{C}$

Notes: